



Simply Better Connections

VE8962

VE8962 True 4K HDMI over IP
Transmitter / Receiver with PoE
User Manual

Compliance Statements

FEDERAL COMMUNICATIONS COMMISSION INTERFERENCE STATEMENT

This equipment has been tested and found to comply with the limits for a Class A digital device, pursuant to Part 15 of the FCC Rules. These limits are designed to provide reasonable protection against harmful interference when the equipment is operated in a commercial environment. This equipment generates, uses, and can radiate radio frequency energy and, if not installed and used in accordance with the instruction manual, may cause harmful interference to radio communications. Operation of this equipment in a residential area is likely to cause harmful interference in which case the user will be required to correct the interference at his own expense.

The device complies with Part 15 of the FCC Rules. Operation is subject to the following two conditions: (1) this device may not cause harmful interference, and (2) this device must accept any interference received, including interference that may cause undesired operation.

FCC Caution

Any changes or modifications not expressly approved by the party responsible for compliance could void the user's authority to operate this equipment.

Warning

Operation of this equipment in a residential environment could cause radio interference.

Achtung

Der Gebrauch dieses Geräts in Wohnumgebung kann Funkstörungen verursachen.

Suggestion

Shield twisted pair (STP) cables must be used with the unit to ensure compliance with FCC & CE standards.



KCC Statement

유선 제품용 / A 급 기기 (업무용 방송 통신 기기)
이 기기는 업무용 (A 급) 전자파적합기기로서 판매자 또는 사용자는 이
점을 주의하시기 바라며, 가정 외의 지역에서 사용하는 것을 목적으로
합니다.

**Trademark Notice:**

The terms HDMI, HDMI High-Definition Multimedia

Interface, HDMI trade dress and the HDMI Logos are trademarks or
registered trademarks of HDMI Licensing Administrator, Inc.

RoHS

This product is RoHS compliant.

User Information

Online Registration

Be sure to register your product at our online support center:

International	http://eservice.aten.com
---------------	---

Telephone Support

For telephone support, call this number:

International	886-2-8692-6959
China	86-400-810-0-810
Japan	81-3-5615-5811
Korea	82-2-467-6789
North America	1-888-999-ATEN ext 4988 1-949-428-1111

User Notice

All information, documentation, and specifications contained in this manual are subject to change without prior notification by the manufacturer. The manufacturer makes no representations or warranties, either expressed or implied, with respect to the contents hereof and specifically disclaims any warranties as to merchantability or fitness for any particular purpose. Any of the manufacturer's software described in this manual is sold or licensed *as is*. Should the programs prove defective following their purchase, the buyer (and not the manufacturer, its distributor, or its dealer), assumes the entire cost of all necessary servicing, repair and any incidental or consequential damages resulting from any defect in the software.

The manufacturer of this system is not responsible for any radio and/or TV interference caused by unauthorized modifications to this device. It is the responsibility of the user to correct such interference.

The manufacturer is not responsible for any damage incurred in the operation of this system if the correct operational voltage setting was not selected prior to operation. PLEASE VERIFY THAT THE VOLTAGE SETTING IS CORRECT BEFORE USE.

Product Information

For information about all ATEN products and how they can help you connect without limits, visit ATEN on the Web or contact an ATEN Authorized Reseller. Visit ATEN on the Web for a list of locations and telephone numbers:

International	http://www.aten.com
North America	http://www.aten-usa.com

Package Contents

Check to make sure that all of the components are in working order. If you encounter any problem, please contact your dealer.

VE8962T

- 1 VE8962T True 4K HDMI over IP Transmitter with PoE
- 1 RS-232 terminal block
- 1 user instructions

VE8962R

- 1 VE8962R True 4K HDMI over IP Receiver with PoE
- 1 terminal block
- 1 user instructions

Contents

Compliance Statements	ii
User Information	v
Product Information	vi
Package Contents	vii
Contents	viii
About This Manual	xiii
Conventions	xiv
1. Introduction and Getting Started	
Overview	1
Features	2
Getting Started Tasks	7
2. Hardware Setup	
Components	9
VE8962T Rear View	10
VE8962T Top View	11
VE8962R Front View	12
VE8962R Rear View	13
VE8962R Top View	14
Mounting the VE8962 Device	15
Wall Mount	15
Rack Mount	15
Connecting VE8962	16
System Alerts	19
Temperature alert	19
Voltage alert	19
Recovery Mode	19
3. Panel Operation	
Overview	21
Basic Operation	22
VE8962T	22
VE8962R	23

Backlight Behavior.....	24
Unlocking the Screen.....	24
Manual Lock	24
Main Menu	25
VE8962T.....	25
VE8962R	26
Setting Device ID (Tx / Rx)	27
System Menu	28
Info Page	29
Reset to Default	30
Reboot.....	31
Assigning Input Video Source to VE8962R	32
Access the Video Menu	32
Choose a Video Source	33
Status Indications.....	34
Recovery Mode.....	34
Finder.....	35

4. Browser Web Control

Overview.....	37
Supported Browsers.....	37
Getting Started.....	38
Looking Up the Device IP Address.....	38
IP Installer.....	38
Device OSD	39
Logging In	40
First Login.....	41
Main Screen.....	44
Device	46
Adding Device	48
Device List	50
Transmitter Tab Page.....	52
Quick Configuration Menu.....	53
IP Address.....	54
EDID	54
HDCP	55
Fast Switching.....	55
Auto Switch HDMI-In	55

USB	55
IR	55
RS-232	55
Baud Rate	56
Action Menu	56
Room Management	57
Create a New Room	58
Edit / Remove an Existing Room	62
Room Configuration	63
Toolbar	65
Create Video Wall	66
Ungroup	69
Create Profile	69
Actions	71
Background Settings	72
Receiver / Video Wall Management	73
Assigning Sources	75
Configuration Menu	75
Source Panel Control	77
Tx Source List	77
Profile Management	79
Creating a Profile	79
Editing or Deleting a Profile	81
Setting Up Profile Schedules	82
Matrix	84
Audio	84
USB	86
IR / RS-232	87
Schedule	89
Create a Scheduled Task	90
Scheduled Tasks Management	92
User	93
Types of User Roles	93
User Account Management	94
Creating a New User Account	94
Deleting an Existing User Account	95
Editing an Existing User Account	95
Maintenance	96

General Settings.....	96
Date & Time	97
Preference	97
CLI	97
Account Lockout Policy	98
Set as Primary Device & Sync to All Other Devices.....	98
SSL Certificate.....	98
System Log.....	98
Firmware Upgrade.....	99
Back Up & Restore	100

5. CLI Commands

Overview.....	101
Access and Authentication.....	101
Access Methods	101
Login and Exit	101
Command Guidelines	102
Command Format and Fields	103
Command Structure	103
Field Formats.....	103
Control Keywords	104
Operation Commands	105
sw – Switch.....	105
vw – Video Wall Switch	105
mute – Audio Mute	106
blankscreen – Blank Screen	106
osd – On-Screen Display	106
edid – Extended Display Identification Data	107
reboot – Reboot Device.....	107
baud – Set RS-232 Baud Rate.....	108
list – List Managed Resources	108
read – Read Device Status.....	109
echo – Echo Events	109
audiomap – Set Audio Source for Tx.....	110
reset – Factory Reset.....	110
hdcp – HDCP Control	111
fastswitch – Set Fast Switching Resolution.....	111
profile – Apply Profile.....	112

hdmiblackscreen – HDMI No-Source Behavior	112
ipinstaller – IPInstaller Mode	113
help – Command Help	113

Appendix

Safety Instructions	115
General	115
Rack Mounting	117
Technical Support	118
Specifications	119
VE8962R	122
Supported Browsers	125
ATEN Warranty Policy	126

About This Manual

This User Manual is provided to help you get the most from your VE8962 device and the ATEN VE Manager. It covers all aspects of installation, configuration, and operation. An overview of the information found in the manual is provided below.

Chapter 1, Introduction and Getting Started, introduces you to the features and purposes of VE8962 True 4K HDMI over IP Transmitter / Receiver with PoE.

Chapter 2, Hardware Setup, introduces you to panel components and provides step-by-step instructions for installing and setting up your VE8962 hardware.

Chapter 3, Panel Operation, provides LED indicator information and functions of the panel pushbuttons.

Chapter 4, Browser Web Control, introduces the VE Manager's main interface and walks through the process of creating and editing display layouts. It also covers general settings and explains how to back up, restore, and upgrade the VE8962 system firmware.

Chapter 5, CLI Commands, provides direct access to system operations, allowing administrators to configure, monitor, and control the VE8962 through text-based instructions.

Appendix, provides product safety instructions, technical support details, and product specifications.

Note:

- ◆ Read this manual thoroughly and follow the installation and operation procedures carefully to prevent any damage to the unit or any connected devices.
 - ◆ The product may be updated, with features and functions added, improved or removed since the release of this manual. For an up-to-date user manual, visit <http://www.aten.com/global/en>
-

Conventions

This manual uses the following conventions:

- | | |
|---|--|
| Monospaced | Indicates text that you should key in. |
| [] | Indicates keys you should press. For example, [Enter] means to press the Enter key. If keys need to be chorded, they appear together in the same bracket with a plus sign between them: [Ctrl+Alt]. |
| 1. | Numbered lists represent procedures with sequential steps. |
| ◆ | Bullet lists provide information, but do not involve sequential steps. |
| > | Indicates selecting the option (on a menu or dialog box, for example), that comes next. For example, Start > Run means to open the <i>Start</i> menu, and then select <i>Run</i> . |
|  | Indicates critical information. |

This Page Intentionally Left Blank

Chapter 1

Introduction and Getting Started

Overview

Adopting advanced compression technology, the ATEN VE8962 Video over IP Extender consists of a transmitter VE8962T and a receiver VE8962R that can transmit up to 4096 x 2160 @ 60 Hz (4:4:4) HDMI, audio, USB 2.0, IR, RS-232 signals with ultra-low latency via a single Cat 5e/6 or fiber optic cable. Additionally, the VE8962 features power redundancy with DC in and Power over Ethernet, over IP redundancy with copper cable and fiber optical cable, operation redundancy with user-friendly web GUI, and control commands by control system.

With a built-in scaler, the VE8962 can easily upscale various input resolutions up to 4096 x 2160 @ 60 Hz, giving viewers the best visual quality across all displays. Moreover, the VE8962 is capable of embedding and de-embedding audio, allowing it to be either embedded in the HDMI stream or extracted and delivered separately.

The extender supports multiple ways of controls including pushbuttons, web GUI, RS-232, bi-directional IR, and Telnet/Reslink. The VE8962 also provides users with user-friendly web GUI to customize control rooms over web for contextual and practical usage. The VE8962 supports USB 2.0 compatibility, enabling users to access USB 2.0 peripherals. For additional local input usage, the VE8962R is equipped with local HDMI input and pushbutton for easy port switching.

Engineered to meet today's demands of large scale, multi-display, True 4K signal transmission, the VE8962 supports AV matrix switch and video wall configurations with up to 80 displays, allowing you to design creative video walls, with a combination of horizontal and vertical displays.

With limitless scalability and flexibility, the VE8962 Video over IP Extender can transmit signals from floor to floor with over IP structure via simple installation, making it an ideal and reliable solution for a wide range of environments, such as trade shows, airports, university campuses, conference centers, and shopping centers.

Features

Light weight Compression with Ultra-low Latency

- ◆ Extends True 4K HDMI signals over IP up to 100 m point-to-point via a single Cat 5e/6 or up to 10 km via fiber optic cable with ultra-low latency
- ◆ Delivers visually lossless high-quality video up to 4096 x 2160 @ 60 Hz (4:4:4)
- ◆ Supports HDR 10 with HDCP 2.2/ 2.3 compliant for content protection
- ◆ Supports individual stereo audio and HDMI audio formats including LPCM 7.1CH, Dolby True HD, Dolby Digital Plus, and DTS-HD Master Audio
- ◆ EDID Expert. selects the optimum EDID settings for smooth power-up, high-quality display, and the best video resolution across different screens

Multiple Redundant Mechanisms

- ◆ Power redundancy – with automatic switching between DC Jack and Power over Ethernet (PoE) when both are supplied, compliant with IEEE 802.3at standard
- ◆ Over IP redundancy – transmitting over IP signals through copper cable and fiber optical cable
- ◆ Operation redundancy – user-friendly Web GUI and multiple control methods

Limitless Scalability and Flexibility

- ◆ Extends AV connections from a simple point-to-point to a multi-point to multi-point setup via LAN without distance limitations
- ◆ Offers multi-functionality in extender, splitter, matrix switch, video wall, and daisy chain applications
- ◆ True 4K Scaler – converting input resolutions to optimum display resolutions
- ◆ Built-in 8KV / 15KV ESD protection
- ◆ Rack-mountable

Quick IP Setup

- ◆ Simple configuration that requires no extensive IT experience or additional learning
- ◆ Assign ID numbers for fast installation, no complex IP settings required
- ◆ Effortlessly switches among input sources via ID number of top panel push buttons

Web GUI-Based Management, No Additional Server PCs or Software Required

- ◆ Intuitive web GUI for central management and can work with all major operating systems
- ◆ Through the “Add Device” page while logging in for the first time on the web GUI, users can easily search all VE8962 devices
- ◆ Operated with imagery and contextualized web GUI, users can classify practical usages by importing environmental pictures to control room intuitively
- ◆ Smooth and clear 720p preview of the source on web GUI

Spontaneous Scheduling Management

- ◆ Offers a user-friendly scheduling management function for users to pre-plan display schedule
- ◆ Provides robust and intuitive scheduling management options to help users manage all events in the calendar to as detailed as to setting events to minute intervals
- ◆ Integrates all VE8962 units to arrange profiles by grouping individual receivers or video wall
- ◆ Multiple profiles can be arranged to play in any order over a selected period of time

Scalable Display Networks with Daisy Chain for Large-Scale Deployments

- ◆ Daisy chain for VE8962R up to 30 units

Note: Only copper cable supports Daisy chain.

- Connects multiple displays through a single port to utilize every port of the network switch and maximize their value
- Easily expandable – cabling and system deployment is easy with no huge network switches and fewer cables needed
- Perfect for large-scale deployment covering hundreds of meters through fiber optical cables, such as trade shows, airports, university campuses, conference centers, and shopping centers

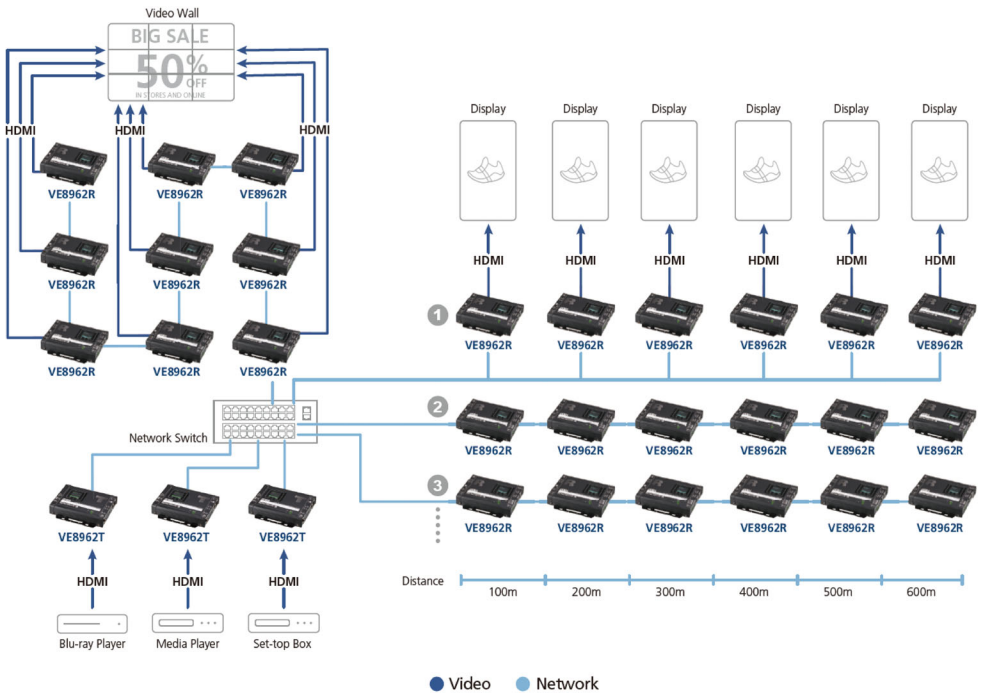

Video Wall Support

- Supports up to 8 x 10 video wall (80 displays)
- Supports horizontal or vertical (90° and 270° rotation) display orientation
- Easily switches layout profiles, previews and drag-and-drop video sources via intuitive web GUI

- ◆ Supports boundless switching, enabling operators to intuitively switch control from one computer to another by moving the mouse cursor across screens

Note: To be included in a future firmware release.

Embedded / De-embedded Audio Support

- ◆ For transmitters – separate stereo audio signals can be embedded into the HDMI stream
- ◆ For receivers – audio streams can be extracted from the HDMI stream and delivered as a separate audio signal
- ◆ Supports Audio Matrix – routes audio from selected transmitters to selected receivers, allowing flexible setup based on different unit requirements

Multiple Control Channels

- ◆ Local HDMI input – the VE8962R is equipped with local HDMI input for additional local input usage and push button for easy port switching
- ◆ LCM display – top-panel LCM display allows for the monitoring of the ID & IP address and device status of the extender
- ◆ USB Connectivity – USB port (USB 2.0) allows for connection of devices such as keyboard, mouse, touch screen, flash drive, printer, and other USB peripherals
- ◆ Bi-directional IR Channel – IR transmission is processed one way at a time
- ◆ RS-232 Channel – bi-directional RS-232 serial port allows for connection of peripherals such as touch screens and barcode scanners
- ◆ Supports Telnet / CLI, and SSH for remote control, management, and authorized security bypass

Collaboration with ATEN Control System

- ◆ Integrated solution – Compatible with ATEN Control System, allowing users to directly operate VE8962T / VE8962R via CLI, Telnet, RS-232 or Reslink protocol

- ◆ Effortless Operation – Simple click to effectively operate VE Manager, TV, projector, source player, and related equipment via touch panel and keypad

Note: If you experience issues related to your network architecture, please refer to the ATEN HDMI over IP Video Extender System Implementation Guide or contact ATEN representatives for assistance.

High-Security Protection

- ◆ AES-256 encryption for AV streaming in SRTP (Secure Real-time Transport Protocol)
- ◆ HTTPS for secure communication

Getting Started Tasks

Follow the steps below to install, connect, configure, and get started with your VE8962 devices.

1. Decide your network architecture and configuration. For more information, see the *ATEN HDMI over IP Video Extender System Implementation Guide*.
2. Mount your VE8962 devices on walls or racks. For more information, see *Mounting the VE8962 Device*, page 15.
3. Connect the VE8962 devices to sources, displays, network, and other hardware devices as required. For more information, see the installation diagrams on *Connecting VE8962*, page 16.
4. Use one of the following methods to assign input sources.

Note: Skip this step if you have a point-to-point setup. In a point-to-point setup, source input is automatically assigned.

- ◆ Assign input sources using the device panel.
For more information, see *Assigning Input Video Source to VE8962R*, page 32.
- ◆ Assign input sources using VE Manager.
For more information, see *Assigning Sources*, page 75.

This Page Intentionally Left Blank

Chapter 2

Hardware Setup



Before you proceed to hardware setup:

1. Please review the safety information regarding the placement of this device in *Safety Instructions*, page 115.
2. Do not power on the VE8962 device until all the necessary hardware is connected.

Components

VE8962T Front View

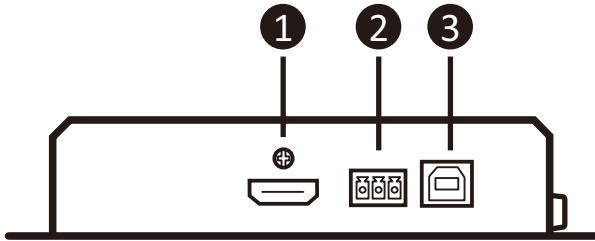

No.	Component	Function
1	HDMI in	Uses an HDMI cable to connect to a source device.
2	RS-232 serial port	Connects to an RS-232 serial devices / peripherals.
3	USB Type-B port	Connects to a source (e.g. PC / Mac).

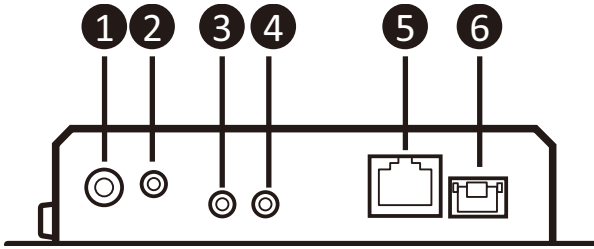
VE8962T Rear View

No.	Component	Function
1	power jack	Connects to the DC power adapter to provide power to the unit.
2	audio in	Connects to an audio source device.
3	IR out	Connects to an IR emitter to allow for configuration using a remote control.
4	IR in	Connects to an IR receiver to allow for configuration using a remote control.
5	RJ-45 port with PoE (LAN)	<p>Uses an Ethernet cable to connect the VE8962T to an Ethernet switch.</p> <p>Note: The VE8962 supports network redundancy. Both the RJ-45 (LAN) and SFP optical port (FSP) can be connected simultaneously. When both ports are active, the optical port is prioritized. If the optical link fails, the system automatically switches to the RJ-45 port.</p>
6	SFP port	<p>Uses an optical fiber cable to connect the VE8962T to the fiber optical network switch.</p> <p>Note: The SFP module is sold separately. Please contact your ATEN dealer for product information.</p>

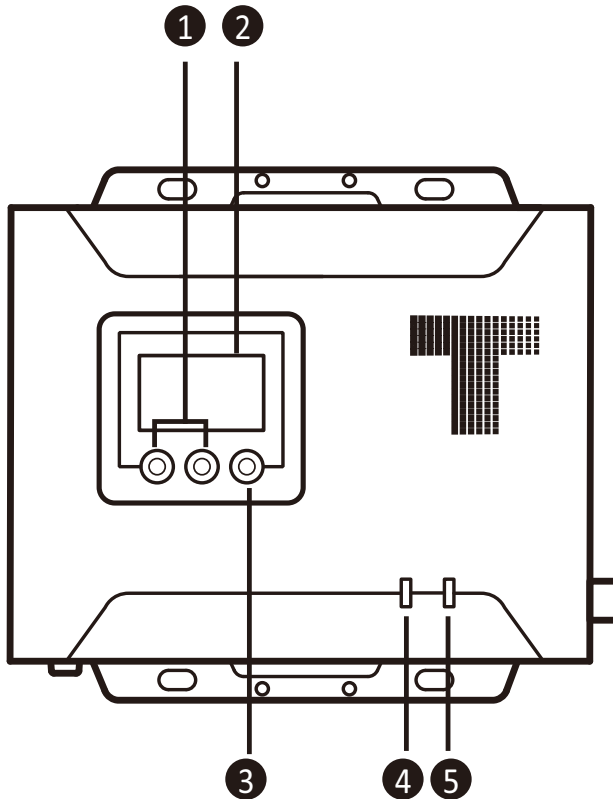
VE8962T Top View

No.	Component	Function
1	prev / next buttons	Uses the prev / next buttons to assign IDs to all VE8962 units and then assign an input source of VE8962T to VE8962R units.
2	LCD display panel	Shows the unit's basic information including ID, IP address, and firmware version.
3	enter button	Uses the enter button to confirm the selection.
4	PoE LED	Lights green to indicate the unit is receiving PoE power.
5	DC in LED	Lights green to indicate the unit is receiving DC power from the power supply.

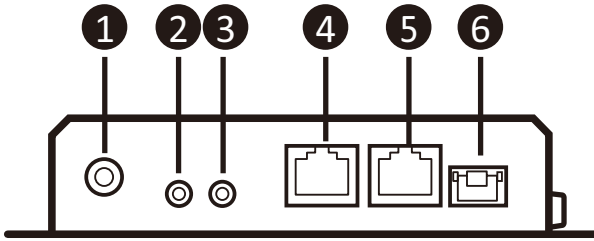
VE8962R Front View

No.	Component	Function
1	power jack	Connects to the DC power adapter to provide power to the unit.
2	IR out	Connects to an IR emitter to allow for configuration using a remote control.
3	IR in	Connects to an IR receiver to allow for configuration using a remote control.
4	RJ-45 port with PoE (LAN 1)	Uses an Ethernet cable to connect the VE8962R to an Ethernet switch. Note: The VE8962 supports network redundancy. Both the RJ-45 (LAN 1) and SFP optical port (FSP) can be connected simultaneously. When both ports are active, the optical port is prioritized. If the optical link fails, the system automatically switches to the RJ-45 port.
5	RJ-45 port (LAN 2)	Uses an Ethernet cable to connect the VE8962R to the next VE8962R's RJ-45 port (LAN 2) for daisy chain connection.
6	SFP port	Uses an optical fiber cable to connect the VE8962R to the fiber optical network switch. Note: The SFP module is sold separately. Please contact your ATEN dealer for product information.

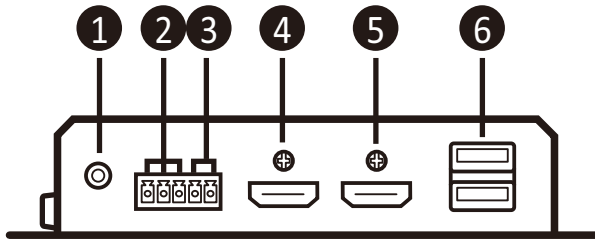
VE8962R Rear View

No.	Component	Function
1	audio out	Connects to an audio output device.
2	RS-232 serial port	Connects to an RS-232 serial devices / peripherals.
3	contact port (+ / GND)	<p>Connect an optional accessory remote port selector to switch video sources connected to the VE8962R or remote over IP sources.</p> <p>Note: The remote port selector is sold separately. Please contact your ATEN dealer for product information.</p>
4	HDMI out	Uses an HDMI cable to connect to a display device.
5	HDMI in	Uses an HDMI cable to connect to a source device.
6	USB Type-A ports	Connects to the USB peripherals such as keyboard and mouse.

VE8962R Top View

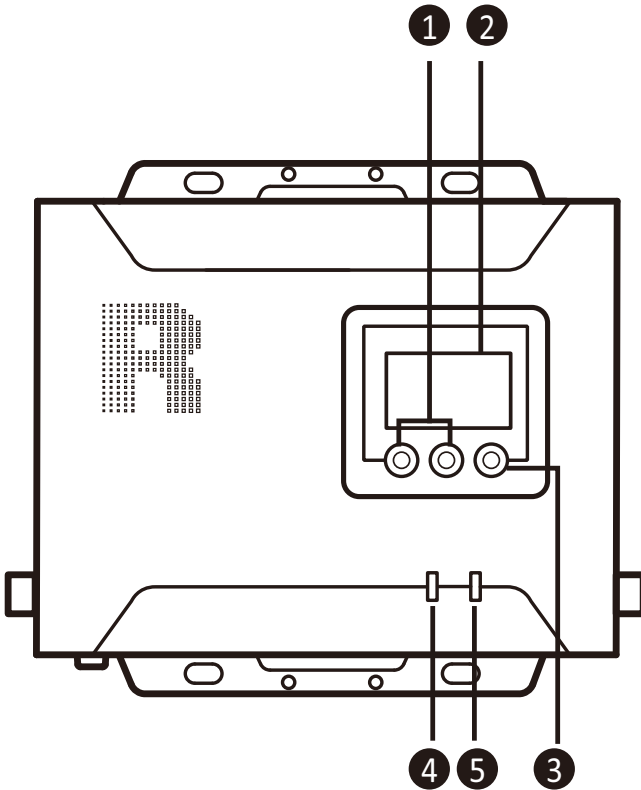

No.	Component	Function
1	prev / next buttons	Uses the prev / next buttons to assign IDs to all VE8962 units and then assign an input source of VE8962T to VE8962R units.
2	LCD display panel	Shows the unit's basic information including ID, IP address, and firmware version.
3	enter button	Uses the enter button to confirm the selection.
4	PoE LED	Lights green to indicate the unit is receiving PoE power.
5	DC in LED	Lights green to indicate the unit is receiving DC power from the power supply.

Mounting the VE8962 Device

Wall Mount

Secure or hang the VE8962T / VE8962R device to the wall using the built-in brackets.

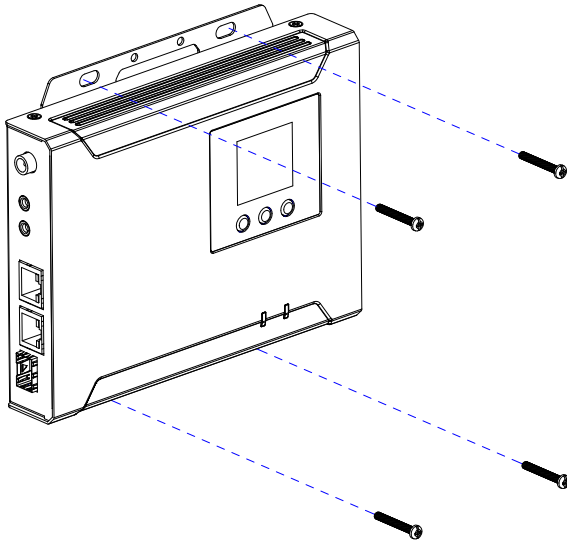

Rack Mount

Use the VE-RMK1U Rack Mount Kit to rack-mount the VE8962. For more information about this accessory, go to www.aten.com/products

Connecting VE8962

Follow the steps below to connect your VE8962 devices with the hardware as required.

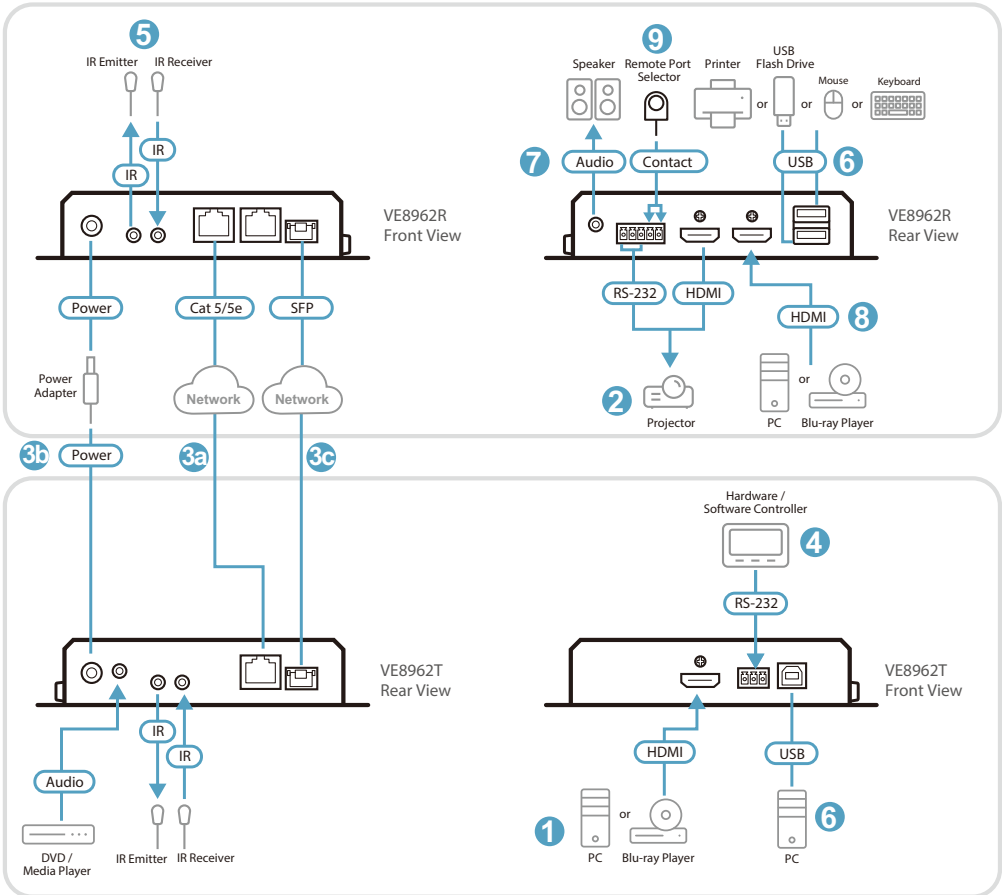

Note: The power adapter is sold separately. Please contact your ATEN dealer for product information.

1. Connect a video source device to the HDMI input port on the VE8962T's front panel using an HDMI cable.
2. Connect a video display device to the HDMI output port on the VE8962R's rear panel using an HDMI cable.
3. Set up the VE8962 units as follows. The diagram above illustrates a point-to-point setup.

◆ **Point-to-point setup:**

- a) Connect one end of an Ethernet cable to the RJ-45 port with PoE (LAN 1) on the VE8962R's front panel and the other end of the cable to the RJ-45 port with PoE (LAN 1) on the VE8962T's rear panel.
- b) Plug the power adapters into the power jacks on the VE8962R's front panel and the VE8962T's rear panel.
- c) Connect one end of an optical fiber cable to the SFP port on the VE8962R's front panel and the other end of the cable to the SFP port on the VE8962T's rear panel.

Note: The SFP module is sold separately. Please contact your ATEN dealer for product information.

◆ **Multipoint-to-multipoint setup:**

- a) Install the VE8962R and VE8962T to the same local area network by connecting the RJ-45 ports with PoE (LAN 1) on the VE8962R's front panel and the VE8962T's rear panel to an Ethernet switch using Ethernet cables.
 - b) The VE8962 can be powered through an Ethernet cable if the unit is connected to a PoE-supported Ethernet switch. Alternatively, plug the power adapters into the power jacks on the VE8962R's front panel and the VE8962T's rear panel for power redundancy.
 - c) Follow step (a) in this procedure to connect the VE8962 unit's SFP ports to an Ethernet switch via optical fiber cables. Alternatively, you can connect both the RJ-45 ports with PoE (LAN 1) and SFP ports for network redundancy.
4. (Optional) To bypass RS-232 signals, connect your computer or control system to the RS-232 serial ports on the VE8962R's rear panel and the VE8962T's front panel.

Note: You can connect RS-232 serial devices / peripherals to the VE8962, such as a PC.

5. (Optional) To bypass IR signals, plug the IR receiver and IR emitter to the IR input and output ports on the VE8962R's front panel and the VE8962T's rear panel.

Note: The IR receiver and emitter are sold separately. Please contact your ATEN dealer for product information.

6. (Optional) To use keyboard and mouse, connect your USB peripherals such as keyboard and mouse to the USB Type-A ports on the VE8962R's rear panel, and your PC to the USB Type-B port on the VE8962T's front panel.
7. (Optional) Connect your audio devices to the audio output port on the VE8962R's rear panel and the audio input port on the VE8962T's rear panel.
8. (Optional) Connect another video source device to the HDMI input port on the VE8962R's rear panel using an HDMI cable.
9. (Optional) Connect an optional accessory remote port selector to switch video sources connected to the VE8962R or remote over IP sources.

Note: The remote port selector is sold separately. Please contact your ATEN dealer for product information.

System Alerts

Temperature alert

A temperature alert is triggered when the device exceeds its limit:

- ♦ VE8962T: > 62 °C
- ♦ VE8962R: > 66 °C

Voltage alert

A voltage alert is triggered when the input voltage is < 4.0 V or > 5.5 V.

Recovery Mode

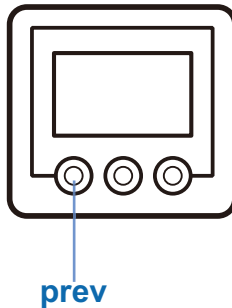

To enter recovery mode:

1. Power off the device.
2. Hold down the prev button and power on the device.
3. Keep holding the prev button for approximately 8 seconds, then release it.

This Page Intentionally Left Blank

Chapter 3

Panel Operation

Overview

The VE8962 front panel features an LCD display and three navigation buttons that allow users to view and configure unit settings. The functions of the buttons are as follows:

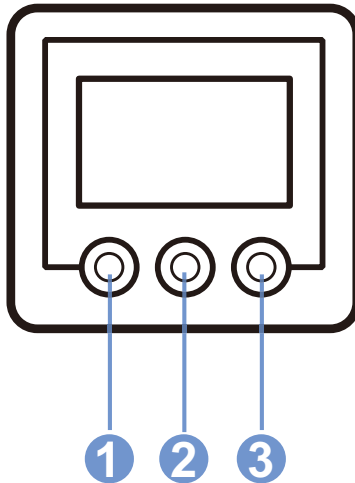

No.	Button	Description
1	prev	Moves to the previous item in the list displayed on the LCD. Press once to go up one item; press and hold to scroll upward continuously.
2	next	Moves to the next item in the list displayed on the LCD. Press once to go down one item; press and hold to scroll downward continuously.
3	enter	Confirms the selected item. Press to enter the detailed page of the selected option for further settings or information.

Basic Operation

Lock Screen

VE8962T

When the VE8962T is powered on, the LCD displays the lock screen with the following information:



No.	Item	Description
1	connection status	Indicates the current network status: <ul style="list-style-type: none"> ◆ ONLINE: The unit is connected to the network. ◆ OFFLINE: No network connection is detected.
2	device ID	Displays the transmitter's ID. The default value is T000.
3	device IP address	Displays the current IP address of the transmitter.
4	lock message	The message Press 3s Unlock prompts the user to press and hold any button for 3 seconds to unlock the panel and enter the main menu. See <i>Main Menu</i> , page 25.

VE8962R

When the VE8962R is powered on, the LCD displays the lock screen with the following information:

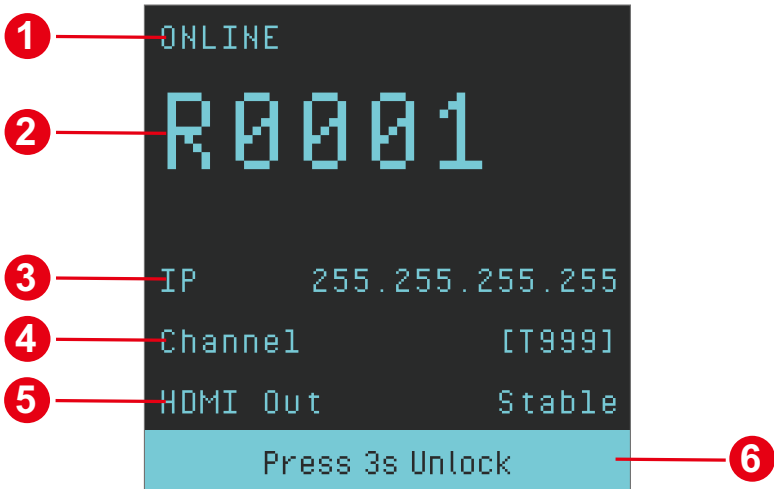

No.	Item	Description
1	connection status	Indicates the current network status: <ul style="list-style-type: none"> ◆ ONLINE: The unit is connected to the network. ◆ OFFLINE: No network connection is detected.
2	device ID	Displays the receiver's ID. The default value is R0000.
3	device IP address	Displays the current IP address of the receiver.
4	input channel	Shows the ID of the paired transmitter (Tx). Displays [N/A] if the connection is lost.
5	HDMI out	Indicates the HDMI output status: <ul style="list-style-type: none"> ◆ Stable: Normal output ◆ Unstable: Signal fluctuation ◆ No Signal: No source detected

No.	Item	Description
6	lock message	The message Press 3s Unlock prompts the user to press and hold any button for 3 seconds to unlock the panel and enter the Rx list page. See <i>Main Menu</i> , page 25.

Screen Lock and Backlight Behavior

When the VE8962's LCD screen enters lock mode, the following behaviors occur:

Backlight Behavior

- ◆ The backlight turns off automatically after 10 seconds of inactivity on the lock screen.
- ◆ To wake up the backlight, press any button once.
- ◆ If no further operation is performed within 10 seconds, the backlight turns off again.

Unlocking the Screen

- ◆ To unlock the screen, press and hold any button for 3 seconds.
- ◆ Once unlocked, the screen remains active and the timer is reset.

Manual Lock

- ◆ To manually lock the screen (from any page), press and hold any button for 3 seconds.
- ◆ Once the screen is locked, the backlight will turn off automatically after 10 seconds of inactivity. Pressing any button once will turn the backlight on without unlocking the screen.

Main Menu

Once the LCD screen is unlocked, the main menu appears, showing the unit's IP address and available settings.

VE8962T

The VE8962T main menu displays the following:

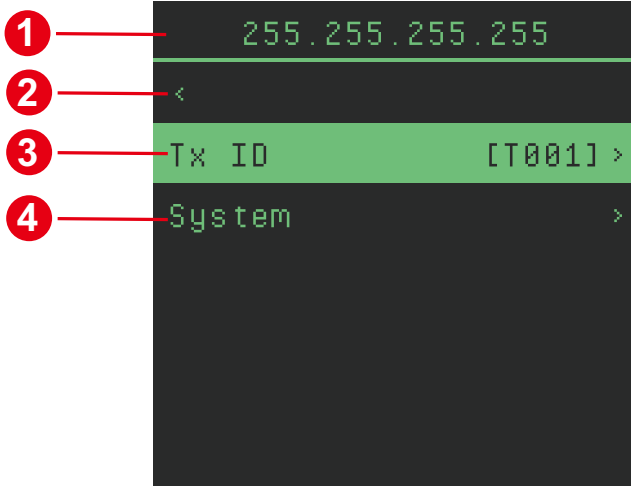

No.	Item	Description
1	IP address	Displays the IP address of the transmitter.
2	back	Returns to the previous page.
3	Tx ID	Shows the current device ID. Enter to modify the transmitter's ID.
4	System	Opens the system settings menu for configuration and status checks.

Use the navigation buttons (prev / next) to browse the options, and press enter to confirm.

VE8962R

The VE8962R main menu displays the following:

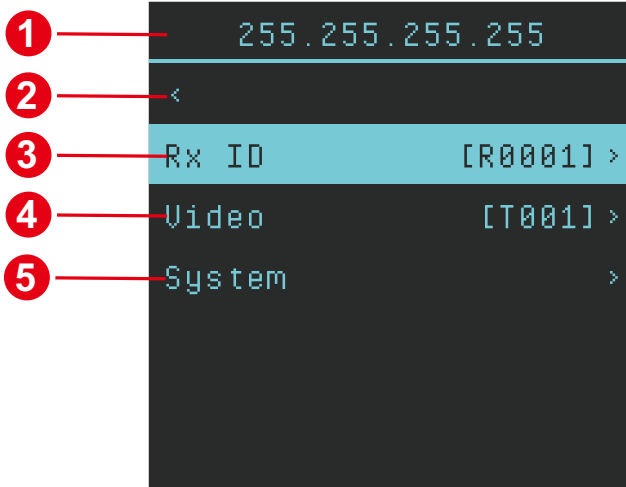

No.	Item	Description
1	IP address	Displays the IP address of the receiver.
2	back	Returns to the previous page.
3	Rx ID	Shows the current device ID. Enter to modify the receiver's ID.
4	Video	Shows the ID of the paired transmitter. Enter to reassign the video source.
5	System	Opens the system settings menu for configuration and status checks.

Use the navigation buttons (prev / next) to browse the options, and press enter to confirm.

Setting Device ID (Tx / Rx)

To configure the device ID on the VE8962, follow the steps below:

1. From the main menu, select the Tx ID or Rx ID item to enter the ID selection screen.

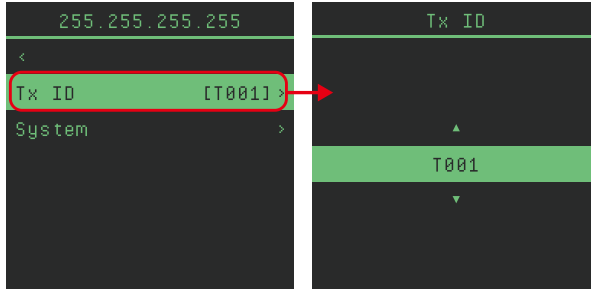

2. Use the navigation buttons (prev / next) to scroll through available IDs.
 - ◆ Available IDs range from:
 - ◆ Tx: T001–T999
 - ◆ Rx: R0001–R1599
 - ◆ When there are more IDs beyond the current view, a triangle icon appears above or below the highlighted line.

Note: Press and hold the navigation button to boost the speed of menu selection.

3. Press the enter button to proceed to the confirmation screen.
4. On the confirmation screen:
 - ◆ Select **OK**, then press **Enter** to apply the selected ID and return to the main menu.
 - ◆ Select **Cancel**, then press **Enter** to discard the change and return to the main menu.



System Menu

From the System menu, users can access device information and perform basic maintenance actions.

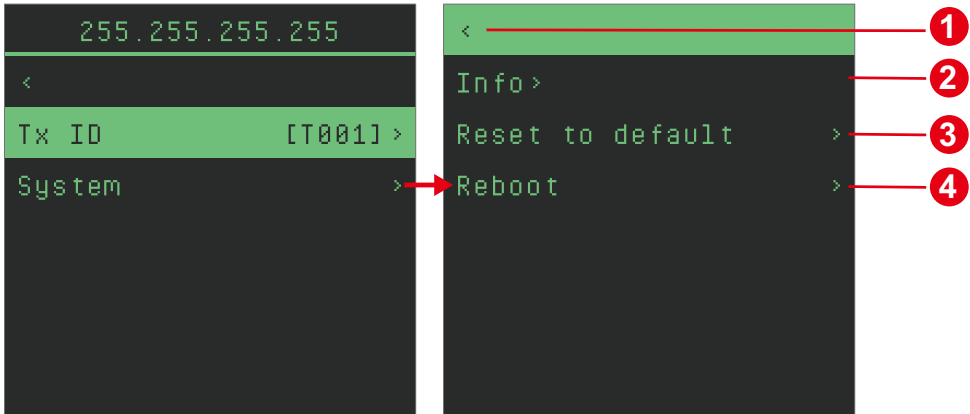

No.	Item	Description
1	back	Returns to the previous page.
2	Info	Info Opens the system information page, including: <ul style="list-style-type: none"> ◆ IP address ◆ firmware version ◆ device temperature
3	Reset to default	Restores the unit to factory settings.
4	Reboot	Powers off and restarts the unit.

Use the navigation buttons (prev / next) to select an item, and press enter to access the corresponding page.

Info Page

The Info page displays current system status..

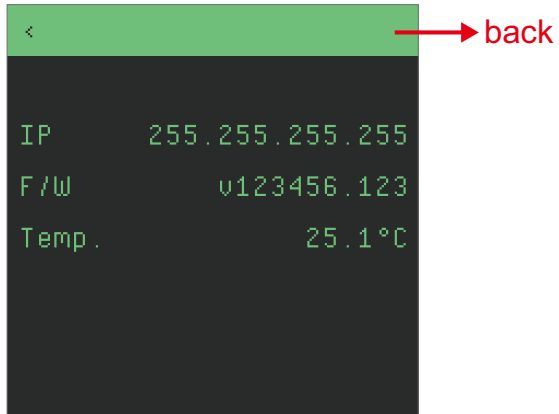

Item	Description
back	Returns to the previous menu.
IP	Shows the unit's current IP address.
F/W	splays the firmware version.
Temp.	Indicates the current internal temperature.

If the temperature exceeds the threshold, a warning icon appears next to the temperature value.

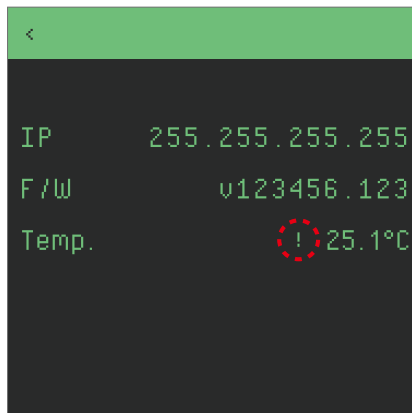

Reset to Default

To restore the VE8962 to the factory default:

1. Use the navigation buttons (prev / next) to select the option **Reset to default**, and then press the enter button.

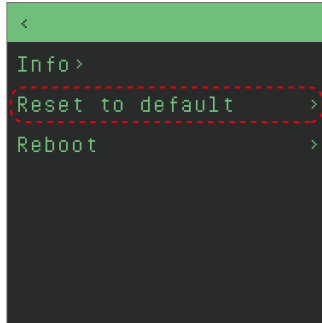

2. On the confirmation screen, select **OK** to perform the reset.

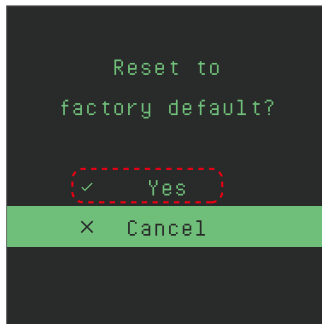

Note: By selecting **Cancel**, you will go back to the system option menu screen.

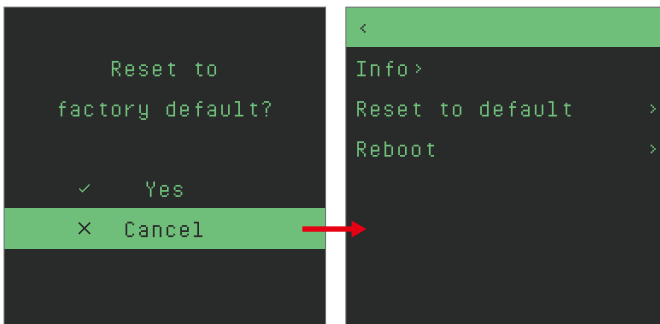

- The reset process starts, and it will take few seconds to complete the process. Once it is done, the unit boots up again and you will enter the main menu screen.

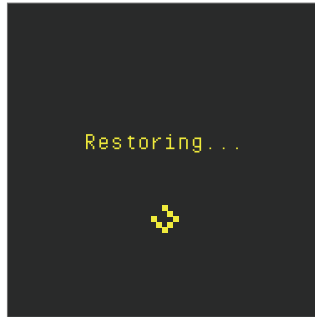

Reboot

To reboot the VE8962 unit, access the system option menu, select **Reboot**, and confirm your selection.

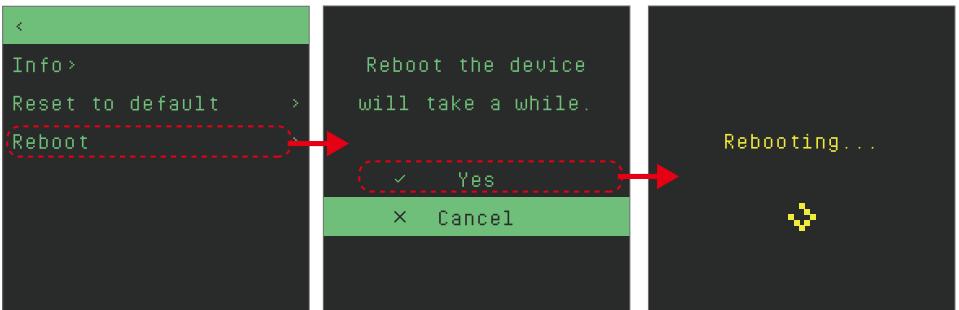

Assigning an Input Video Source to VE8962R

To assign a video input to VE8962R, follow the steps below:

Access the Video Menu

- From the main menu of VE8962R, select Video to enter the video input configuration screen.

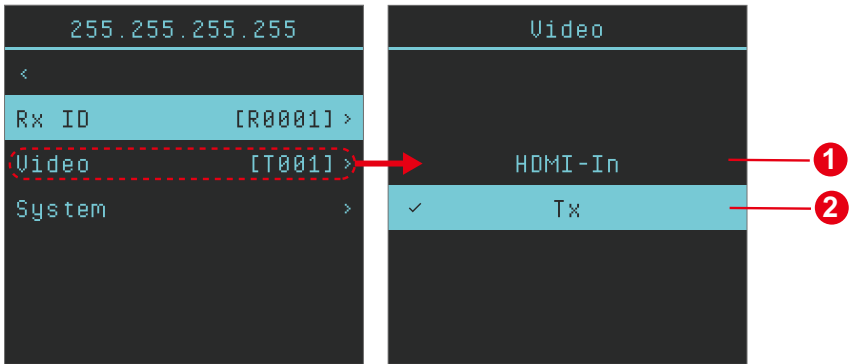

No.	Item	Description
1	HDMI-In	Select the video source from the device connected to the HDMI input port of this VE8962R unit.
2	Tx	Select the video source from a VE8962T unit on the same network. Access the Tx list screen to view available transmitters.

The currently-connected video source is marked with a tick icon.

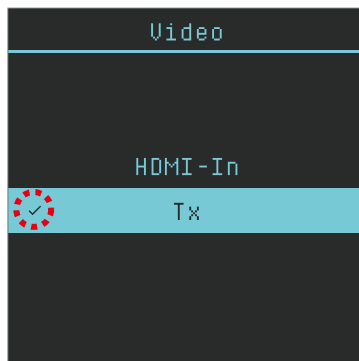

Choose a Video Source

2. You can select one of the following options:

- ◆ **HDMI-In:**

Select this option to use the video source from the device connected to this VE8962R unit's HDMI input port.

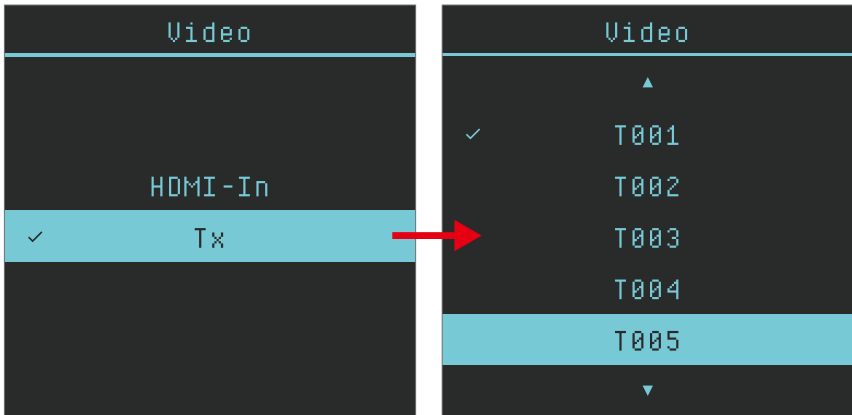

- ◆ **Tx:**

Select this option to use the video source from a VE8962T unit connected to the same network. The available Tx IDs will be displayed for selection..

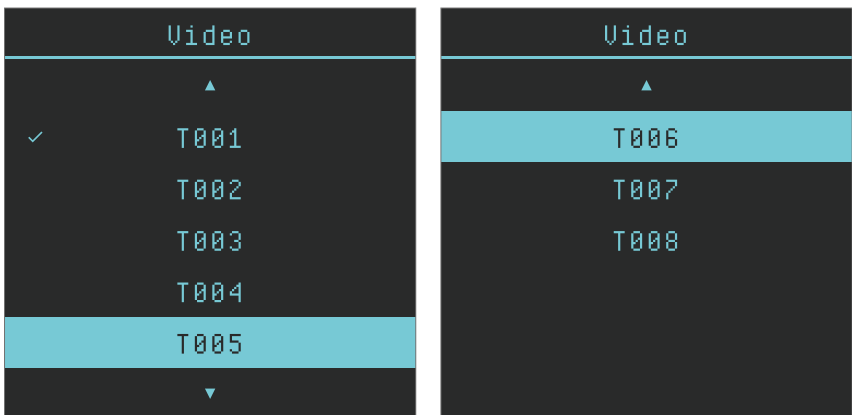

Note: Press and hold the navigation button to boost the speed of menu selection.

Status Indications

Firmware Upgrade

Displayed when the device is processing a firmware upgrade task and needs to indicate the current progress.

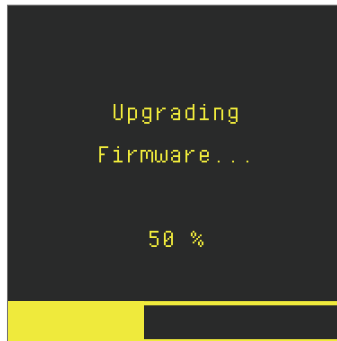

The bar dynamically updates with percentage values until the operation is complete.

Recovery Mode

Displayed when the device enters Recovery Mode.

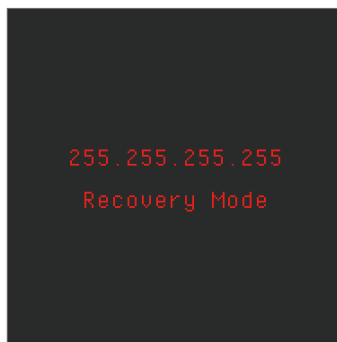

Only the device IP address and the **Recovery Mode** message are shown on the panel for troubleshooting purposes.

Finder

Displayed when the **Finder** function is triggered from the web interface. The device panel blinks to help users identify the physical unit.

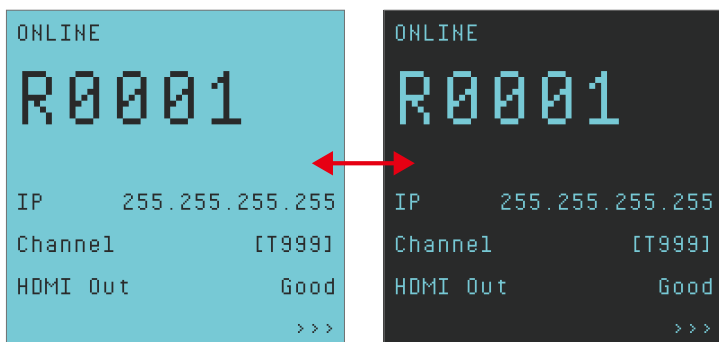

Blinking stops when:

- ◆ Stopped manually from the web GUI
- ◆ Any button on the panel is pressed
- ◆ The 60-second timeout is reached

This Page Intentionally Left Blank

Chapter 4

Browser Web Control

Overview

The VE8962 transceiver can be remotely and centrally managed using a built-in utility program, the ATEN VE Manager. Accessed through a web browser, this utility provides a central platform that allows you to configure transmitter and receiver settings.

Supported Browsers

Please see the table below for supported web browsers and the versions.

Web Browser	Supported Versions
Google Chrome	115 or later
Mozilla Firefox	115 or later
Microsoft Edge	115 or later
Opera	100 or later
Safari	17 or later

Getting Started

Go through this section to learn about how to access VE Manager and manage your VE8962 transmitters and receivers.

Looking Up the Device IP Address

To access ATEN VE Manager, you need to get the device IP address first.

IP Installer

Follow the steps below to get the device IP address using the ATEN utility program, **IP Installer**.

1. Download the utility **IP Installer** from the *Support and Downloads* tab of the product page.

The screenshot shows two browser windows. The left window displays the 'IP Installer Utility Download Page' with a 'Proceed' button highlighted by a red box. A red arrow points from this button to the 'I Agree' button on the right window, which shows the 'Non-Warranted Software' license agreement. The 'I Agree' button is also highlighted by a red box.

Release Note | ATEN Corporate Headquarters - Google...
aten.com/global/en/products/release-note

Welcome to **IPInstaller Utility Download Page**
This utility can discover ATEN over IP products in and provide a simple method to configure IP relat

Notice: Before downloading the software , be sure following information carefully.

This latest version contains corrections to the las additions to the next version. You will find them lis

Version History		
Version	Description	Note
V1.4.134	1. Added	IP Installer works following modat

Non-Warranted Software
Important : Read carefully before using the software. Aten international (hereinafter 'aten') will license the software to you only if you first accept the terms of this agreement. By using, installing, or otherwise using the software you agree to be bound by the terms and conditions stated . If you do not agree to the terms and conditions, do not install, copy, or use the software.
The software is owned by Aten International Ltd., Co. or one of its subsidiaries, and is copyrighted and licensed, not sold. This Agreement includes - General Terms and - Country-unique Terms and is the complete agreement regarding the use of this Software, and replaces any prior oral or written communications between you and Aten International. The Country unique terms may replace or modify those of the General terms.
License
Aten grants you a nonexclusive license to use the Software. You may use the software and make and install copies to support the level of use authorized, providing you reproduce the copyright notice and any other legends of ownership on each copy, or partial copy, of the Software. You will ensure that anyone who uses the Software does so only in

Proceed → **I Agree** | I Disagree

2. Unzip the .zip file of the IP Installer and then run the .exe file.

- Obtain the IP address of the unit from the Device List, and use this IP address to access the unit's VE Manager.

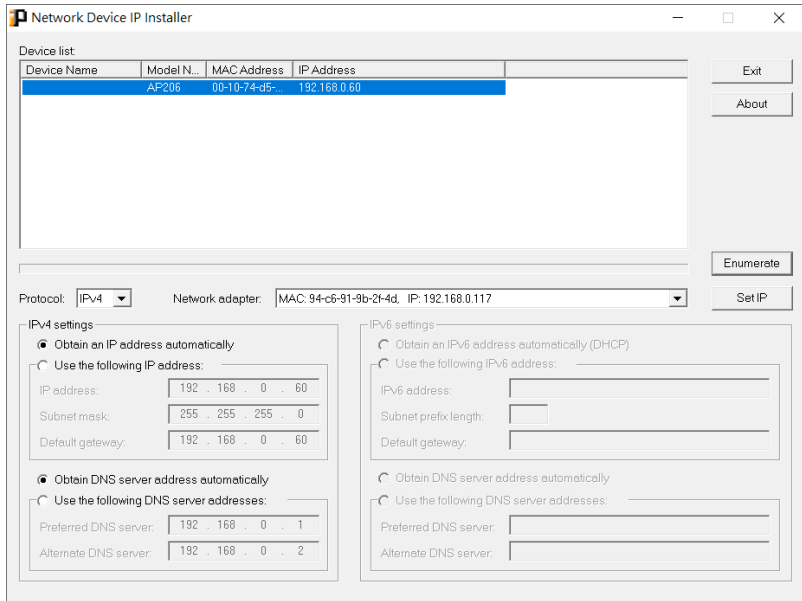

Device OSD

The device IP address is shown on the OSD. Check your device to obtain the IP address:

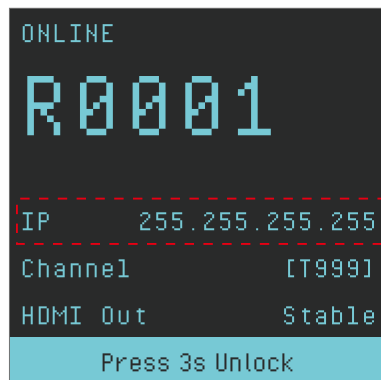
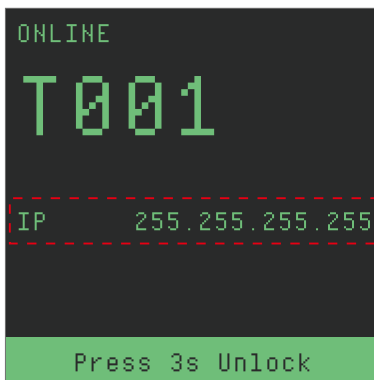

Logging In

Follow the steps below to log in to VE Manager:

1. Start up the supported web browser, and then input the unit's IP address into the address bar.
2. The login page shows up. Enter your username and password, select the display language, and then click on **Login** button to continue.

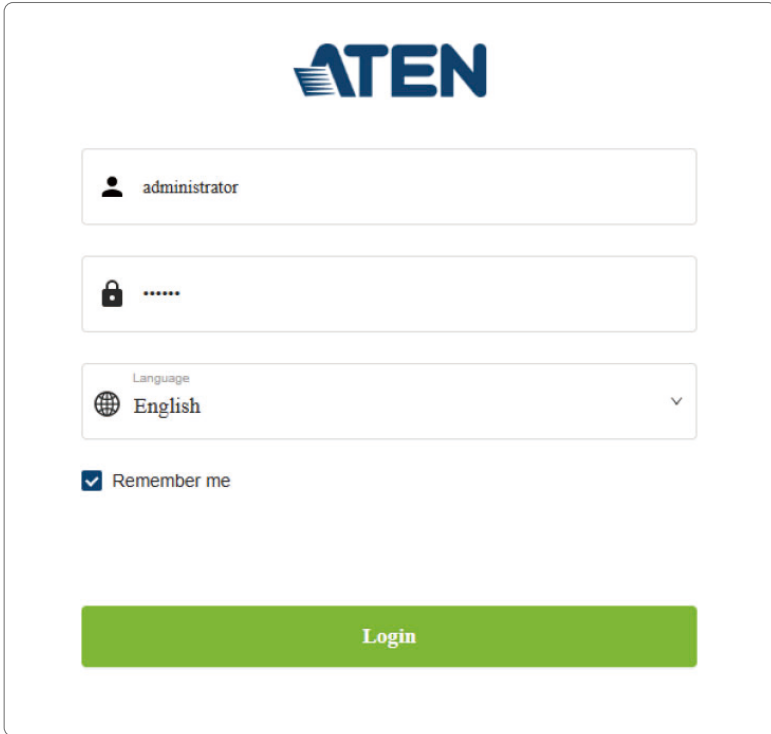

The screenshot shows the ATEN login interface. At the top center is the ATEN logo. Below it are three input fields: a username field containing 'administrator', a password field with masked characters '.....', and a language selection dropdown menu currently set to 'English'. Below the language field is a checked checkbox labeled 'Remember me'. At the bottom of the form is a large green button with the text 'Login' in white.

First Login

Upon first login (including the first time you log in to VE Manager after resetting the unit), you are required to set up the following settings:

1. Changing Password

- a) You are prompted to change the login password. Click **OK** to proceed.

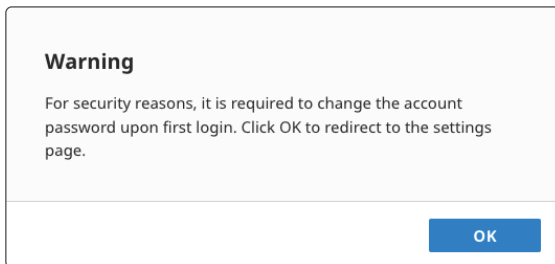

Warning

For security reasons, it is required to change the account password upon first login. Click OK to redirect to the settings page.

OK

- b) Enter the new password and confirm your changed password in the relevant fields. Click **Save**.

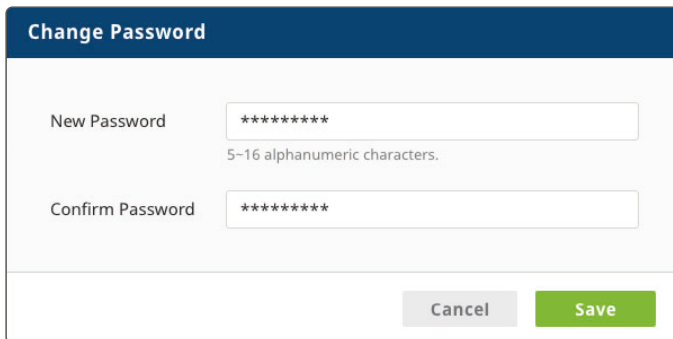

Change Password

New Password
5-16 alphanumeric characters.

Confirm Password

Cancel **Save**

- c) A message "Password changed successfully" will be displayed. Click **OK** to log in again using the new password.

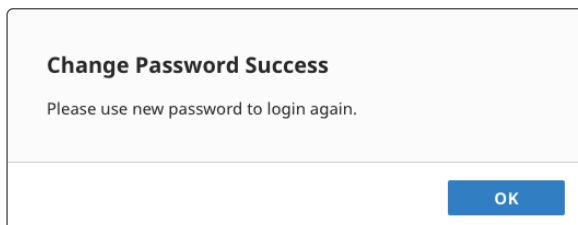

Change Password Success

Please use new password to login again.

OK

2. Updating Date & Time

Select the mode to set up the date and time.

Settings	Description
Mode	<p>Select between the two modes:</p> <ul style="list-style-type: none"> ◆ Manual: Set the date and time manually. By selecting Manual, the function Date & Time below becomes available. Choose the date and time from the date picker and time picker. ◆ NTP Server: Set the Network Time Protocol (NTP) to synchronize the clock between the unit and the server.
Date & Time	<p>Set the date and time from the date picker and time picker.</p> <p>Note: The function is only available when Manual mode is enabled.</p>
Sync with Computer Time	<p>If you wish to synchronize the time with the computer's time, click the button to process the settings.</p>

3. Adding Devices

Follow the on-screen instructions to add device(s) to be controlled and managed. See *Adding Device*, page 48 for details.

Add Device
✕

1 Select Devices
2 Setting IP & Device Name
3 Setting IP
4 Confirm Setting

Transmitter (999) Refresh

ID	Device Name	MAC Address	ID Type	IP	Subnet Mask	Gateway	Primary DNS	Secondary DNS	Find Me	
<input type="checkbox"/>	T001	VE8962T	E9-35-BH-2R-11	Auto	255.255.255.255	255.255.255.255	255.255.255.255	255.255.255.255	255.255.255.255	Q
<input type="checkbox"/>	T002	VE8962T	E9-35-BH-2R-11	Auto	255.255.255.255	255.255.255.255	255.255.255.255	255.255.255.255	255.255.255.255	Q
<input type="checkbox"/>	T003	VE8962T	E9-35-BH-2R-11	Auto	255.255.255.255	255.255.255.255	255.255.255.255	255.255.255.255	255.255.255.255	Q
<input type="checkbox"/>	T004	VE8962T	E9-35-BH-2R-11	Auto	255.255.255.255	255.255.255.255	255.255.255.255	255.255.255.255	255.255.255.255	Q
<input type="checkbox"/>	T005	VE8962T	E9-35-BH-2R-11	Auto	255.255.255.255	255.255.255.255	255.255.255.255	255.255.255.255	255.255.255.255	Q
<input type="checkbox"/>	—	IP CAM Module	E9-35-BH-2R-11	—	255.255.255.255	255.255.255.255	255.255.255.255	255.255.255.255	255.255.255.255	—

Receiver (999) Refresh

ID	Device Name	MAC Address	ID Type	IP	Subnet Mask	Gateway	Primary DNS	Secondary DNS	Find Me	
<input type="checkbox"/>	R001	VE8962R	E9-35-BH-2R-11	Auto	255.255.255.255	255.255.255.255	255.255.255.255	255.255.255.255	255.255.255.255	Q
<input type="checkbox"/>	R002	VE8962R	E9-35-BH-2R-11	Auto	255.255.255.255	255.255.255.255	255.255.255.255	255.255.255.255	255.255.255.255	Q
<input type="checkbox"/>	R003	VE8962R	E9-35-BH-2R-11	Auto	255.255.255.255	255.255.255.255	255.255.255.255	255.255.255.255	255.255.255.255	Q
<input type="checkbox"/>	R004	VE8962R	E9-35-BH-2R-11	Auto	255.255.255.255	255.255.255.255	255.255.255.255	255.255.255.255	255.255.255.255	Q
<input type="checkbox"/>	R005	VE8962R	E9-35-BH-2R-11	Auto	255.255.255.255	255.255.255.255	255.255.255.255	255.255.255.255	255.255.255.255	Q
<input type="checkbox"/>	R005	VE8962R	E9-35-BH-2R-11	Auto	255.255.255.255	255.255.255.255	255.255.255.255	255.255.255.255	255.255.255.255	Q





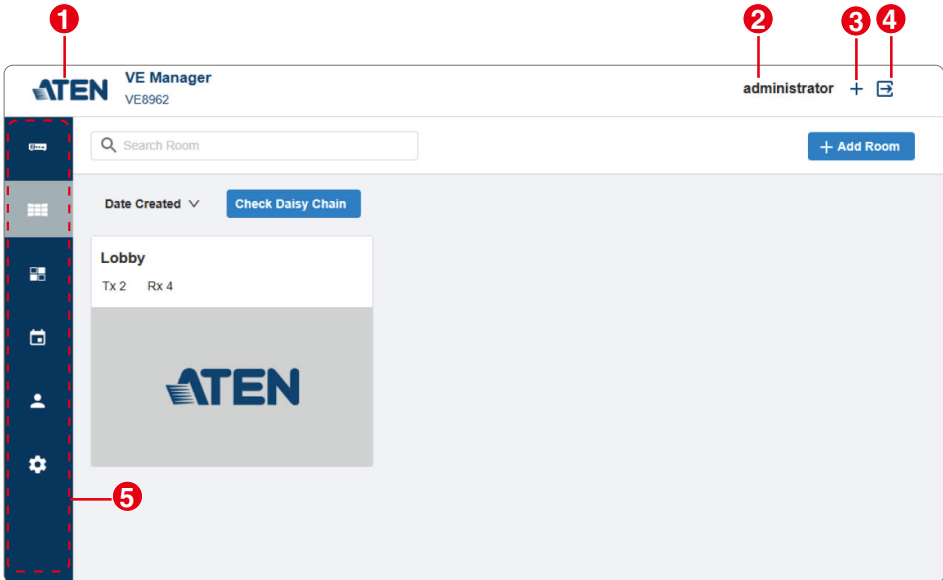

Cancel Next

Main Screen

Once you log in to the unit's VE Manager, you will enter the **Room** page. The main screen features the following functions:



No.	Item	Description
1		Click on the ATEN logo that takes you straight to ATEN's official website.
2	signed-in account	Shows the account you use to log in to VE Manager.
3	add device(s)	Click to open the Add Device popup. This option is available to administrators only.
4	logout	Click to log out and you will redirect to the login page.

No.	Item	Description
5	side menu	<p>Click to access other pages:</p> <ul style="list-style-type: none"> <li data-bbox="416 220 934 403">  Device: The Device page provides an overview of all connected transmitters and receivers, allowing you to monitor their status and perform configuration, batch editing, or device management with ease. <li data-bbox="416 419 964 603">  Room: The Room page allows you to create, manage, and customize virtual rooms, configure video walls, switch transmitters, and control receiver settings for a seamless AV setup. <li data-bbox="416 619 956 802">  Matrix: The Matrix page allows you to manage and control audio, USB, IR, and RS232 signal routing between transmitters and receivers with options for patching, muting, and synchronization. <li data-bbox="416 818 967 1002">  Schedule: The Schedule page allows you to create, view, and manage scheduled tasks in either calendar or list view, with options for time ranges, repeats, and multiple profiles. <li data-bbox="416 1018 953 1169">  User: The User page allows administrators to create, edit, and manage user accounts with different access levels for system functions. <li data-bbox="416 1185 964 1393">  Maintenance: The Maintenance page provides system maintenance settings, including date and time configuration, panel lock preferences, CLI access, account lockout policy, firmware updates, and backup/restore options.

Device

The **Device** page serves as the central hub for managing all VE8962 devices connected to the system. Administrators can view device information, add new devices, or remove unused entries as needed. Basic configuration options ensure that each device is properly registered and accessible. Certain functions are available only to users with administrator privileges.

The Device page lists your VE8962 units as illustrated below.

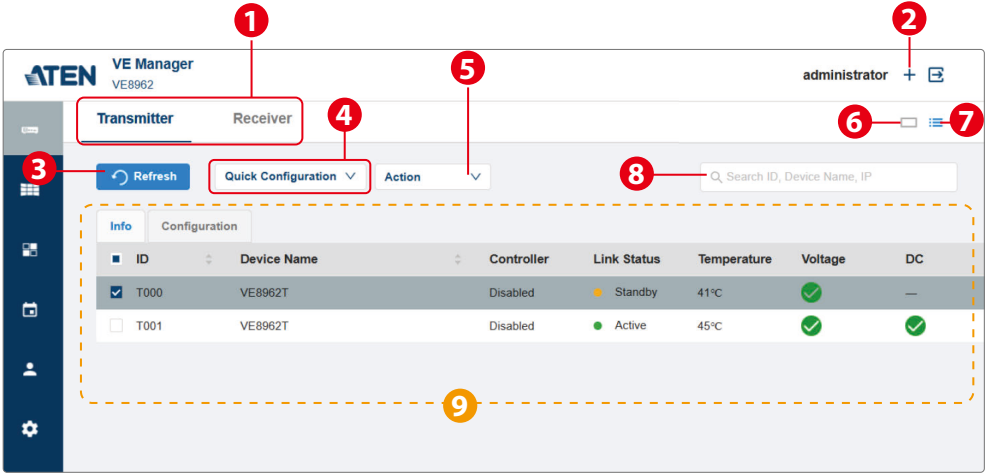

No.	Item	Description
1	tab bar	Click to enter the tab page to list your devices by: ♦ Transmitter : only the VE8962 transmitters ♦ Receiver : only the VE8962 receivers
2	add device	Click on the add device button + to open Add Device popup to select the VE8962 unit(s) you'd like to add to your VE Manager.
3	refresh button	Use the refresh button to reload the device list and ensure the latest device status is shown.
4	quick configuration menu	Select your VE8962 unit(s) from the device list and then choose the setting to be configured for the selected device(s).

No.	Item	Description
5	action menu	Select your VE8962 unit(s) from the device list and then choose the action to be taken on the selected device(s).
6	tile view	Displays transmitters as individual tiles with basic identification and a preview image (if available), allowing a quick visual overview of connected devices.
7	list view	Presents transmitters in a tabular format with detailed information such as status, temperature, and power input, enabling easier data comparison and device management.
8	search bar	Enter your search terms or keywords to filter the list of matching device(s).
9	device list	Shows your VE8962 units with the unit's information on info tab while the configuration tab shows the VE8962 units with the editable information and settings.

Adding Device

To add more VE8962 units to VE manager for centralized management, do the following:

1. Click on the add device button **+** to open **Add Device** popup.
2. Select the device(s) to be added by checking the checkbox(es), and then click **Next**.

The screenshot shows the 'Add Device' popup window with four steps: 1. Select Devices, 2. Setting IP & Device Name, 3. Setting IP, and 4. Confirm Setting. It displays two tables: 'Transmitter (999)' and 'Receiver (999)'. Both tables have columns for ID, Device Name, MAC Address, ID Type, IP, Subnet Mask, Gateway, Primary DNS, Secondary DNS, and Find Me. Callouts 1-6 highlight specific UI elements: 1. A vertical red box around the checkboxes in the transmitter table; 2. A red box around the 'select all' checkbox; 3. A red circle around the 'Refresh' button; 4. A red circle around the 'Find Me' button; 5. A red circle around the 'Cancel' button; 6. A red circle around the 'Next' button.

No.	Item	Description
1	checkbox	Selects the transmitter(s) / receiver(s) you'd like to add to VE Manager.
2	select all	Selects all the transmitter(s) / receiver(s).
3	refresh	Updates the available device list.
4	find me	Makes the LED of the selected unit(s) blink to help user find where the unit(s) is located.
5	cancel	Discards the adding device process and close the adding device popup.
6	next	Goes to the next step.

- Follow the on-screen instruction to configure the device ID, the device name, and device IP address.

Add Device

1 Select Devices 2 Setting IP & Device Name 3 Setting IP 4 Confirm Setting

Transmitter (999) Auto Assign ID

ID	Device Name	MAC Address	ID Type	IP	Subnet Mask	Gateway	Primary DNS	Secondary DNS	Find Me
T 001	VE8962T	E9-35-8H-2R-11	Auto	255.255.255.255	255.255.255.255	255.255.255.255	255.255.255.255	255.255.255.255	Q
T 002	VE8962T	E9-35-8H-2R-11	Auto	255.255.255.255	255.255.255.255	255.255.255.255	255.255.255.255	255.255.255.255	Q
T 003	VE8962T	E9-35-8H-2R-11	Auto	255.255.255.255	255.255.255.255	255.255.255.255	255.255.255.255	255.255.255.255	Q
T 004	VE8962T	E9-35-8H-2R-11	Auto	255.255.255.255	255.255.255.255	255.255.255.255	255.255.255.255	255.255.255.255	Q
T 005	VE8962T	E9-35-8H-2R-11	Auto	255.255.255.255	255.255.255.255	255.255.255.255	255.255.255.255	255.255.255.255	Q

Receiver (999) Auto Assign ID

ID	Device Name	MAC Address	ID Type	IP	Subnet Mask	Gateway	Primary DNS	Secondary DNS	Find Me
R 001	VE8962R	E9-35-8H-2R-11	Auto	255.255.255.255	255.255.255.255	255.255.255.255	255.255.255.255	255.255.255.255	Q
R 002	VE8962R	E9-35-8H-2R-11	Auto	255.255.255.255	255.255.255.255	255.255.255.255	255.255.255.255	255.255.255.255	Q
R 003	VE8962R	E9-35-8H-2R-11	Auto	255.255.255.255	255.255.255.255	255.255.255.255	255.255.255.255	255.255.255.255	Q
R 004	VE8962R	E9-35-8H-2R-11	Auto	255.255.255.255	255.255.255.255	255.255.255.255	255.255.255.255	255.255.255.255	Q
R 005	VE8962R	E9-35-8H-2R-11	Auto	255.255.255.255	255.255.255.255	255.255.255.255	255.255.255.255	255.255.255.255	Q
—	IP CAM Module	E9-35-8H-2R-11	—	255.255.255.255	255.255.255.255	255.255.255.255	255.255.255.255	255.255.255.255	—

Cancel **Next**

- Confirm your configuration and click on **Save** to add the selected device(s).

Add Device

1 Select Devices 2 Setting IP & Device Name 3 Setting IP 4 Confirm Setting

Transmitter (999)

ID	Device Name	MAC Address	ID Type	IP	Subnet Mask	Gateway	Primary DNS	Secondary DNS	Find Me
T001	VE8962T	E9-35-8H-2R-11	Auto	255.255.255.255	255.255.255.255	255.255.255.255	255.255.255.255	255.255.255.255	Q
T002	VE8962T	E9-35-8H-2R-11	Auto	255.255.255.255	255.255.255.255	255.255.255.255	255.255.255.255	255.255.255.255	Q
T003	VE8962T	E9-35-8H-2R-11	Auto	255.255.255.255	255.255.255.255	255.255.255.255	255.255.255.255	255.255.255.255	Q
T004	VE8962T	E9-35-8H-2R-11	Auto	255.255.255.255	255.255.255.255	255.255.255.255	255.255.255.255	255.255.255.255	Q
T005	VE8962T	E9-35-8H-2R-11	Auto	255.255.255.255	255.255.255.255	255.255.255.255	255.255.255.255	255.255.255.255	Q
—	IP CAM Module	E9-35-8H-2R-11	—	255.255.255.255	255.255.255.255	255.255.255.255	255.255.255.255	255.255.255.255	—

Receiver (999)

ID	Device Name	MAC Address	ID Type	IP	Subnet Mask	Gateway	Primary DNS	Secondary DNS	Find Me
R001	VE8962R	E9-35-8H-2R-11	Auto	255.255.255.255	255.255.255.255	255.255.255.255	255.255.255.255	255.255.255.255	Q
R002	VE8962R	E9-35-8H-2R-11	Auto	255.255.255.255	255.255.255.255	255.255.255.255	255.255.255.255	255.255.255.255	Q
R003	VE8962R	E9-35-8H-2R-11	Auto	255.255.255.255	255.255.255.255	255.255.255.255	255.255.255.255	255.255.255.255	Q
R004	VE8962R	E9-35-8H-2R-11	Auto	255.255.255.255	255.255.255.255	255.255.255.255	255.255.255.255	255.255.255.255	Q
R005	VE8962R	E9-35-8H-2R-11	Auto	255.255.255.255	255.255.255.255	255.255.255.255	255.255.255.255	255.255.255.255	Q
R006	VE8962R	E9-35-8H-2R-11	Auto	255.255.255.255	255.255.255.255	255.255.255.255	255.255.255.255	255.255.255.255	Q

Cancel **Save**

- Now you can find the VE8962 units you just added on the device list.

Device List

The device list itemizes your VE8962 units for you to check and configure. The **Info** tab offers the device information for you to check while the **Configuration** tab shows their editable settings.

◆ Info Tab:

ID	Device Name	Connect	Link	Temperature	Voltage	DC	PoE	Fiber	Cat	Action
<input type="checkbox"/> R0000	VE8962R	T001	● Active	48°C	✓	✓	✓	—	✓	
<input type="checkbox"/> R0001	VE8962R	T001	● Active	49°C	✓	✓	✓	—	✓	
<input type="checkbox"/> R0002	VE8962R	T001	● Active	50°C	✓	✓	✓	—	✓	
<input type="checkbox"/> R0003	VE8962R	T001	● Active	48°C	✓	✓	✓	—	✓	

◆ Configuration Tab:

ID	Device Name	IP	Fast Switching	USB	IR	RS-232	Baud rate	Action
<input type="checkbox"/> R0000	VE8962R	169.254.0.100	disable	Enable	Enable	Bypass	115200	
<input type="checkbox"/> R0001	VE8962R	169.254.0.101	1920x1080	Enable	Enable	Bypass	115200	
<input type="checkbox"/> R0002	VE8962R	169.254.0.102	1920x1080	Enable	Enable	Bypass	115200	
<input type="checkbox"/> R0003	VE8962R	169.254.0.103	1920x1080	Enable	Enable	Bypass	115200	

Double-click on a unit to open the unit’s configuration window. Make change of this unit and save to apply the changes.

R0000
✕

Device ID/Name R 0000 VE8962R

IP Address

IP Type Manual ▼

IP Address 169.254.0.100

Subnet Mask 255.255.255.0

Gateway 169.254.0.254



Video Settings

Fast Switching disable ▼

Auto Switch HDMI-In Enable

Reset to default
Cancel
Save

You can click on the action buttons to directly perform the following actions:

Action		Description
	Edit Device	Opens the device's configuration window to make changes.
	Find Me	Makes the LED of the selected unit(s) blink to help user find where the unit(s) is located.

Note: The limitation for a device name is up to 27 characters, no special characters allowed.

Transmitter Tab Page

On **Transmitter** tab page, you can switch the device list display between list view and tile view:

- ◆ List View  :

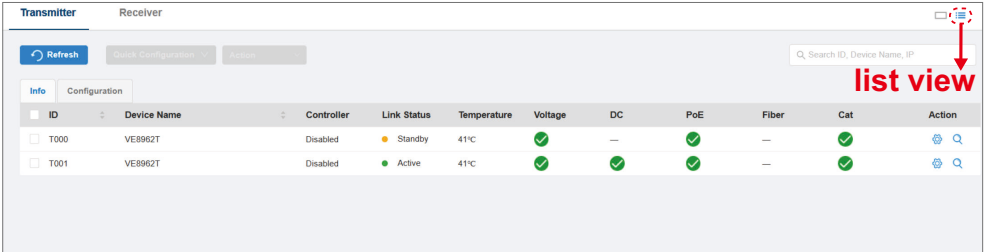

- ◆ Tile View  :

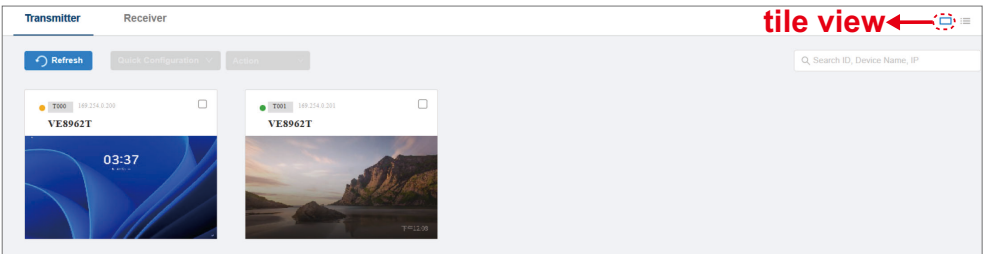

In the tile view, you can:

1. Select a unit by checking the checkbox on its tile card.
2. Access the **Quick Configuration** and **Action** menus for further operations.

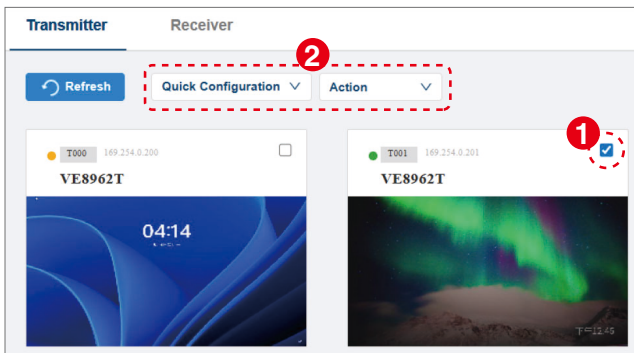

Quick Configuration Menu

To quickly get a specific setting done on the VE8962 unit(s), do the following:

1. Select one or more units by checking the checkbox(es) from the device list.

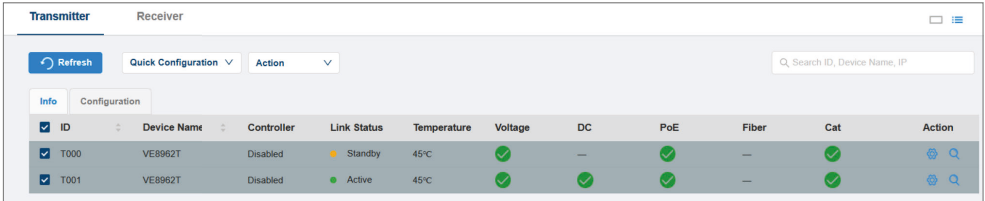

ID	Device Name	Controller	Link Status	Temperature	Voltage	DC	PoE	Fiber	Cat	Action		
<input checked="" type="checkbox"/>	T000	VE8962T	Disabled	Standby	45°C	✓	—	✓	—	✓		
<input checked="" type="checkbox"/>	T001	VE8962T	Disabled	Active	45°C	✓	✓	✓	—	✓		

2. The **Quick Configuration** menu options are not identical between the Transmitter and Receiver tabs. Each side provides different functions based on the unit type you select.
From **Quick Configuration** drop-down menu, select the setting option you'd like to configure.

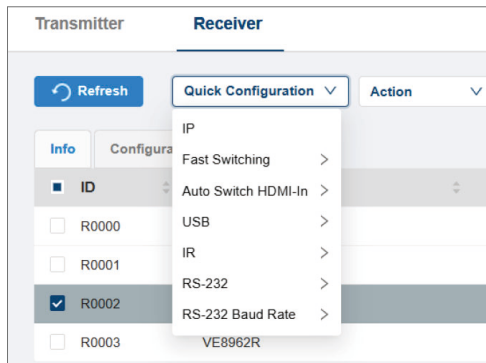
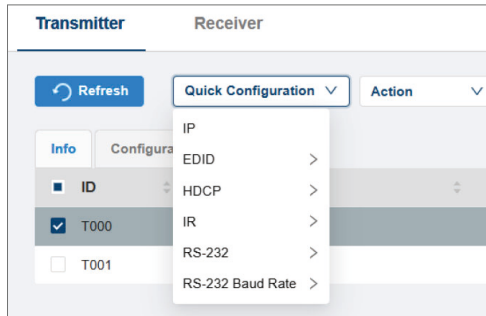

IP Address

Specifies how the unit obtains its IP address. Options on **IP Configuration** drop-down menu are:

IP Configuration

IP Type: Manual (selected) | DHCP | Auto IP

ID	Current IP	Revised IP	Subnet Mask	Gateway
T000	169.254.0.200	169.254.0.200	255.255.0.0	169.254.0.254
T001	169.254.0.201	169.254.0.201	255.255.0.0	169.254.0.254

Buttons: Cancel, Save

- ◆ **DHCP:**
Select this option to have the IP address automatically assigned by a DHCP server.
- ◆ **Auto IP:**
Select this option to have the IP address automatically assigned by the VE Manager.
- ◆ **Manual:**
Select this option to designate an IP address for the device. Manually type the IP Address, Subnet Mask, and Gateway for the device.

EDID

- ◆ **Remix (default):**
Combines EDID data from connected displays to derive the optimal configuration. If EDID data cannot be retrieved, the system automatically applies the ATEN Default EDID.
- ◆ **ATEN Default:**
Uses ATEN's predefined EDID list to select a resolution supported by the VE8662 capabilities.

- ◆ **Manual:**
Allows administrators to assign EDID from a connected receiver via Web, CLI, or RS-232. The assigned EDID will be stored for use. If no valid receiver is available, the system automatically reverts to the default setting.

HDCP

Select whether to enable HDCP for the VE8962T or not.

Fast Switching

Click to define the resolution for fast switching. For best performance, ATEN recommends setting this to match your video source resolution and ensuring the same setting is applied across all VE8962 receivers.

Auto Switch HDMI-In

Select enable or disable the **Auto Switch HDMI-In** function.

When an HDMI source is plugged in, the VE8962R automatically switches to the HDMI input. The input port cannot be changed until the source is disconnected or Auto Switching mode is disabled. If the HDMI source is unplugged, the unit reverts to the previous port.

USB

Enable or disable the reception of signals from connected USB devices

IR

Enable or disable the reception of IR signals.

RS-232

Enable or disable the configuration and control of the VE8962 unit via RS-232 commands when connected to a host computer or other device, such as a control system.

- ◆ Command Mode: Enable
- ◆ Bypass: Disable
- ◆ Telnet to RS-232 router

Baud Rate

Select a suitable baud rate for the unit.

Action Menu

To take an action on the selected device(s), do the following:

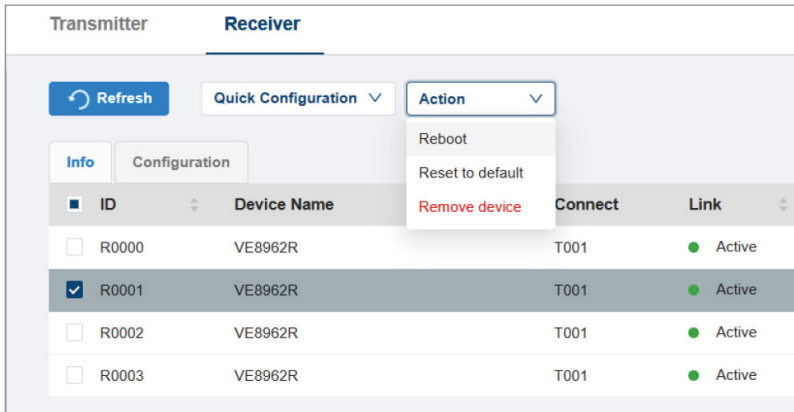

1. Select the VE8962 unit(s) by checking the checkbox(es).
2. Choose the action to be taken from the **Action** drop-down menu.

Action	Description
Reboot	Turn off the selected unit(s) and then immediately start it again.
Reset to Default	Restore the selected unit(s) to the factory default.
Remove Device	Remove the selected unit(s) from VE Manager.

Room Management

A room in VE Manager is similar to the room mailbox in Microsoft 365. It is virtual and created in VE Manager, and assigned to a physical location, such as a meeting room, to help users to manage, operate, and configure the resources (transmitters, receivers, and monitors) that belong to this room. Room main page displays all the rooms, including the default room **Lobby** and the user-created room. Access the **Room** main page to organize the use of virtual rooms and manage the VE8962 devices.

Note: The default room **Lobby** cannot be deleted and renamed.

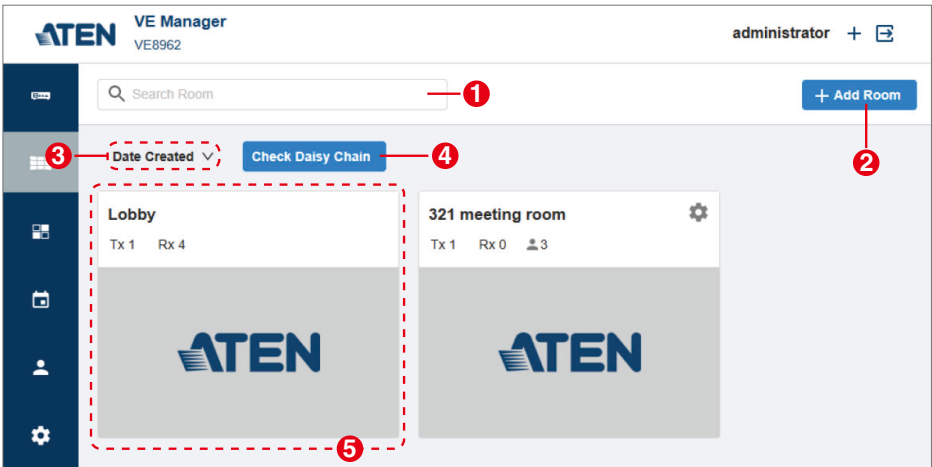

No.	Item	Description
1	search bar	Enter the keyword of the room you'd like to find to quickly display the room cards that fit the keyword.
2	add room	Click the add room button to create a new room.
3	sorting dropdown menu	Select the sort order to display your rooms: <ul style="list-style-type: none"> ◆ Created: Sorting the rooms by their created time. ◆ A to Z: Sorting the rooms in A–Z order.
4	check daisy chain	Checks the receiver daisy-chain status in this room and reports any connection issues.
5	room card	Display the basic information of the virtual room. Click on the room card to access the configuration page of this room.

Create a New Room

To create a new room, do the following:

1. Click on **Add Room** button to open **Room Management** popup.

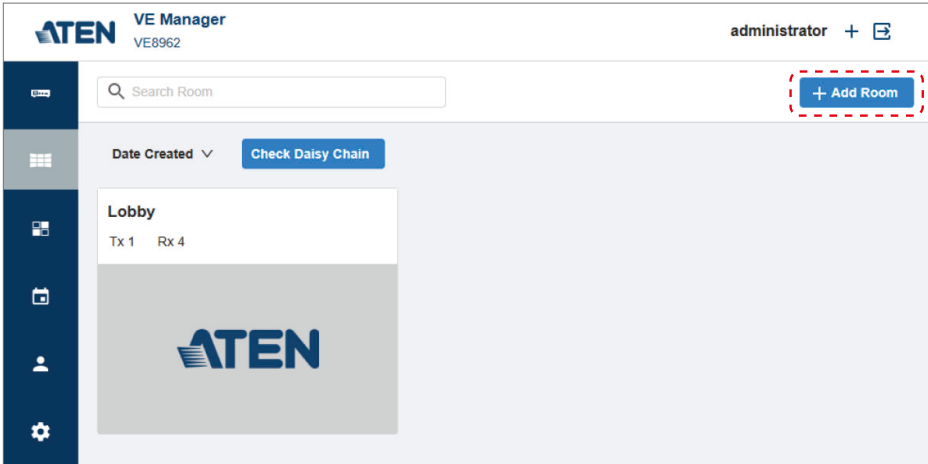

2. In the **Available Tx** tab, specify a name for the room and assign one or more available transmitters to it. The limitation for a device name is up to 30 characters, no special characters allowed.

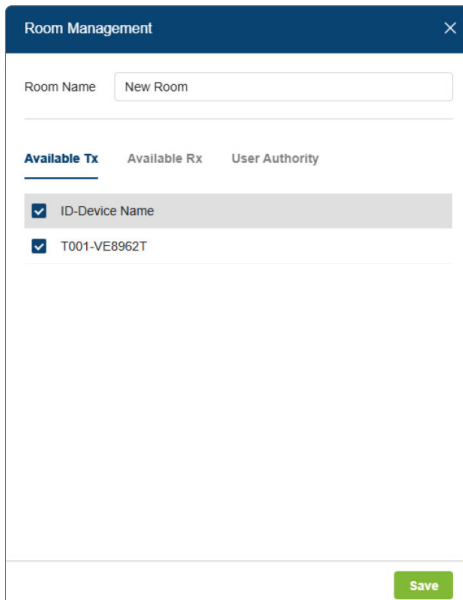

3. In the **Available Rx** tab, assign the available receiver(s) to the room. Each room can include up to 32 receivers.

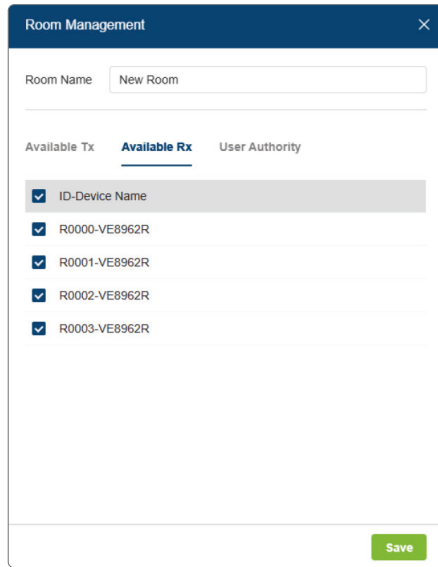

The screenshot shows the 'Room Management' window with the 'Available Rx' tab selected. The 'Room Name' field contains 'New Room'. Below the tabs, there are three sections: 'Available Tx', 'Available Rx', and 'User Authority'. The 'Available Rx' section is active and contains a list of four receivers, each with a checked checkbox: 'ID-Device Name', 'R0000-VE8962R', 'R0001-VE8962R', 'R0002-VE8962R', and 'R0003-VE8962R'. A green 'Save' button is located at the bottom right of the window.

4. In the **User Authority** tab, assign users to either the **Access Restricted** list or the **Access Permitted** list.

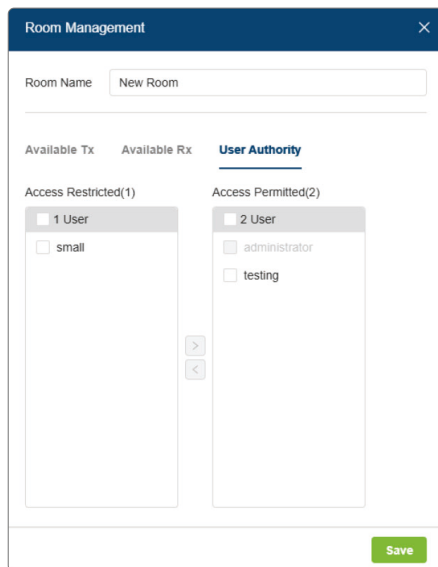

The screenshot shows the 'Room Management' window with the 'User Authority' tab selected. The 'Room Name' field still contains 'New Room'. The 'User Authority' section is active and contains two lists: 'Access Restricted(1)' and 'Access Permitted(2)'. The 'Access Restricted' list has one user, 'small', with an unchecked checkbox. The 'Access Permitted' list has two users, 'administrator' and 'testing', both with unchecked checkboxes. There are navigation arrows between the two lists. A green 'Save' button is located at the bottom right of the window.

5. Click the save button to complete the new room settings.

The room is successfully created and its room card is displayed on room list:

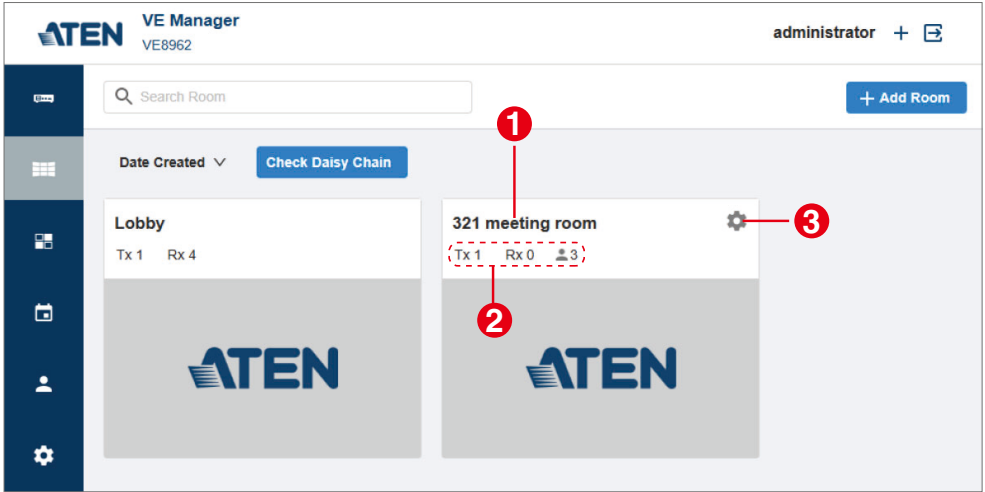

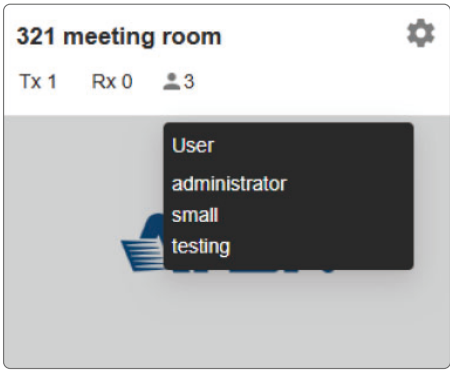
No.	Item	Description
1	room name	The name you specify for this room. Note: The limitation for a device name is up to 30 characters, no special characters allowed.
2	device and user list tooltip	Hovering over the Tx count, Rx count, or User icon displays a tooltip listing the corresponding transmitter IDs, receiver IDs, or user accounts assigned to the room. 

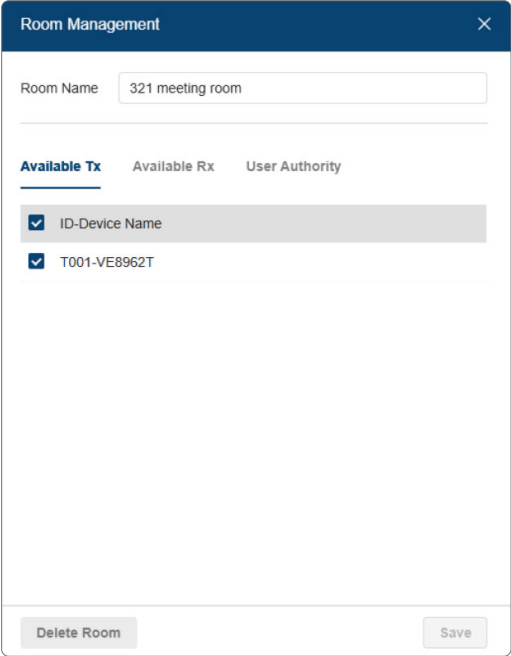
No.	Item	Description
3	room settings button	<p>Opening the room management popup to edit the room or delete the room.</p>  <p>Note: This function is not available to the default room, Lobby.</p>

Note: A maximum of 32 rooms (including Lobby) is supported.

Edit / Remove an Existing Room

To edit the room settings or remove an existing room, click on the setting button to open the room management popup.

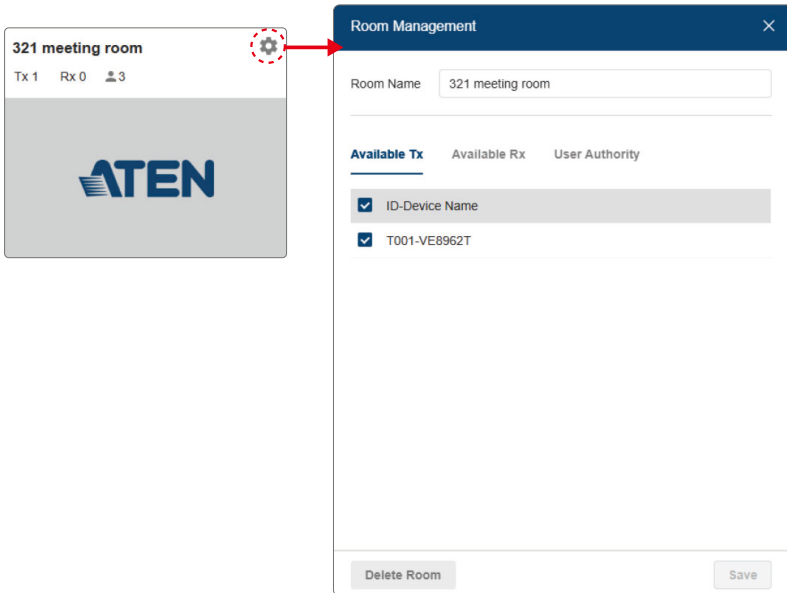

- ◆ Make changes and save.
- ◆ To delete the room, click on the delete button and confirm your action.

Note: Once the room is deleted, the device(s) belongs to this room will be dispatched to the default room, Lobby.

Room Configuration

Double-click on the room card to access its configuration page for additional editing..

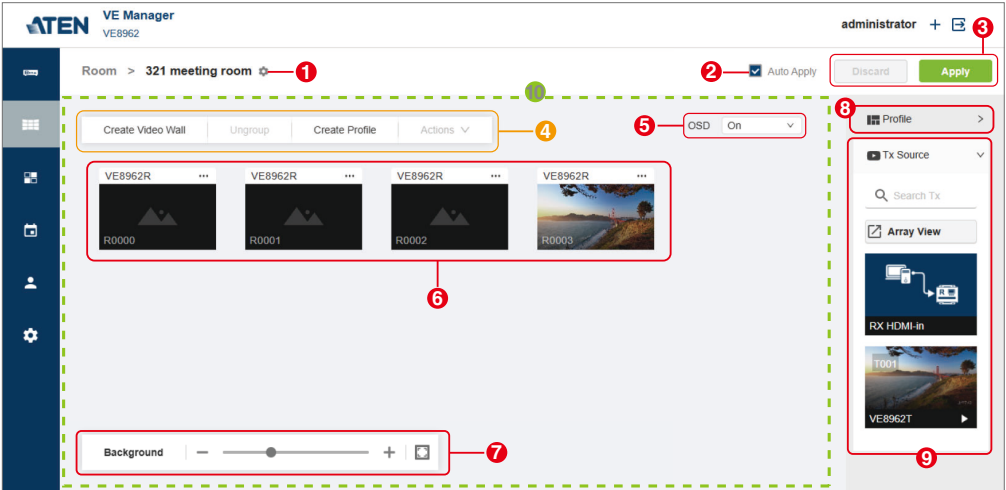

No.	Item	Description
1	settings	Clicks to open the room management popup for the options: <ul style="list-style-type: none"> ◆ Rename the room ◆ Add or remove device(s) and manage user access ◆ Delete the room Note: This function is not available for the default room, Lobby.
2	auto apply	Enable the function Auto Apply , and the changes you made in this room take effect immediately.
3	apply / discard	If Auto Apply is disabled, you can: <ul style="list-style-type: none"> ◆ Apply: Apply the changes you just made. ◆ Discard: Cancel your changed settings.
4	toolbar	Provides a set of buttons and an action menu that allows user to manage the receivers belong to this room. See <i>Toolbar</i> , page 65 for details.

No.	Item	Description
5	OSD setting	<p>Sets whether to present the receiver information, including receiver ID, model name, device IP address, and anomaly warning on the output displays. The options are:</p> <ul style="list-style-type: none"> ◆ Off: Disable the function. ◆ On: Enable the function. ◆ 10 Sec.: Display the receiver information for 10 seconds everytime an event occurs.
6	receiver / video wall card	<p>The receiver(s) / video wall(s) belongs to this room. Drag the card to a preferred position and release it to have it placed.</p>
7	background settings	<p>With the background settings tool, you can:</p> <ul style="list-style-type: none"> ◆ Resizes the receiver / video wall cards displayed on the room configuration page. ◆ Allows you to upload a background image such as a site layout of this room to help you organize the devices.
8	profile list	<p>Select an existing profile to apply. Refer to profile management for details.</p>
9	Tx source list	<p>The Tx source list contains the following:</p> <ul style="list-style-type: none"> ◆ search bar: Enter the keyword (device ID or device name) to find the transmitter(s) you need. ◆ array preview: Click to open a window that displays the available video sources. ◆ transmitter list: Only the available transmitter(s) is displayed. Drag the transmitter video source to the receiver / video wall, and then release it to have it output to the correspond display monitor(s).
11	arrangement area	<p>The place where the receiver / video wall card(s) is placed on.</p>

Toolbar

Toolbar brings you a set of buttons to perform functions on the receiver(s) / video wall.

For the **Action** menu items, select the target receiver(s) or video wall first. Click on a receiver or video wall card to select it—the card frame will be highlighted in blue.

For the **Ungroup** function specifically, make sure to select a video wall card.

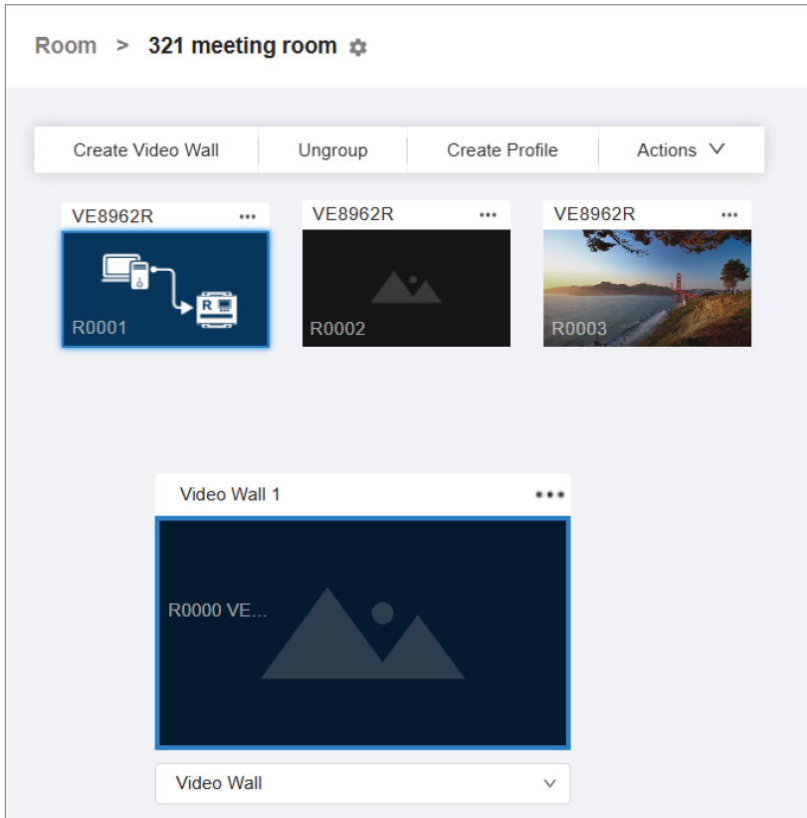

To deselect the target card, please click on it again.

Create Video Wall

Click the **Create Video Wall** button. A confirmation dialog appears; once confirmed, the **Create Video Wall** popup opens.

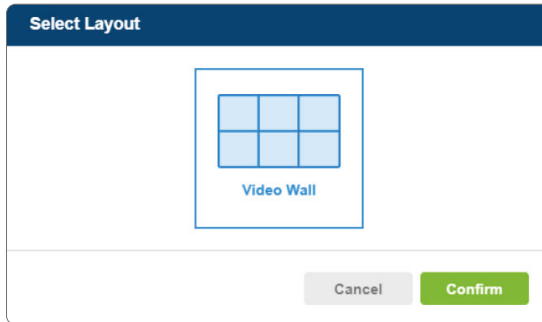

Follow the steps below to create a video wall:

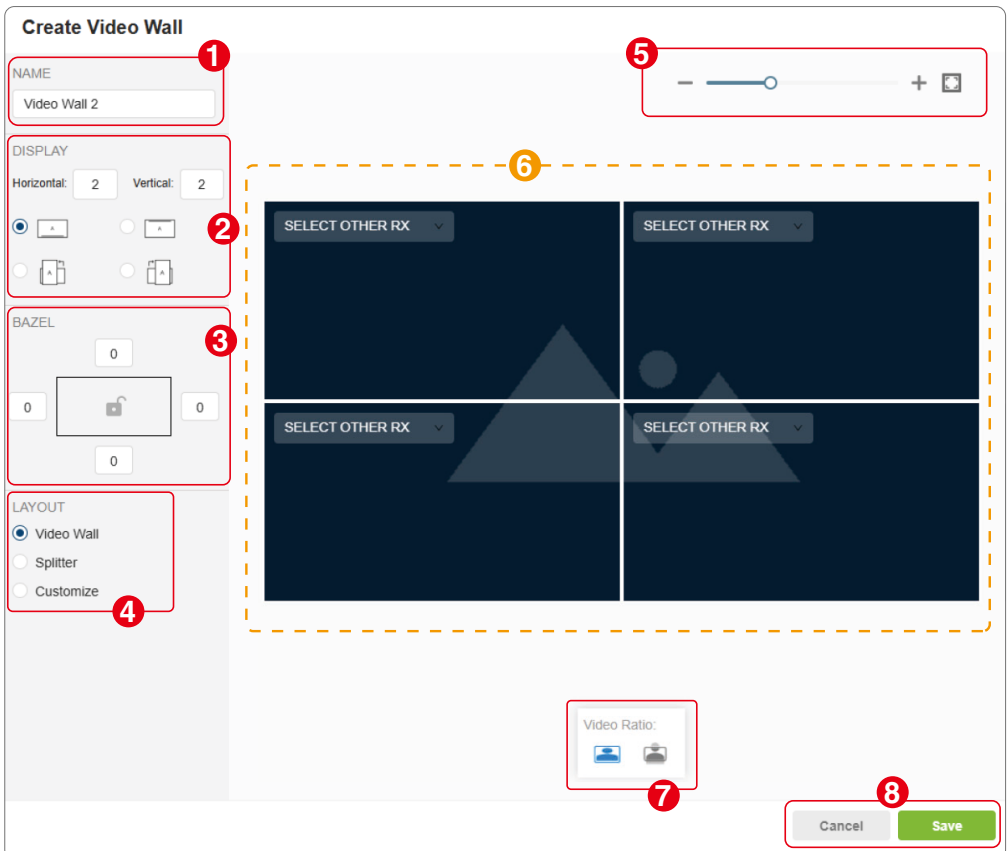



The image shows the "Create Video Wall" configuration screen with eight numbered steps:

- 1**: The "NAME" field is set to "Video Wall 2".
- 2**: The "DISPLAY" section shows "Horizontal: 2" and "Vertical: 2". The "Video Wall" layout is selected.
- 3**: The "BAZEL" section shows a lock icon and the number "0".
- 4**: The "LAYOUT" section shows "Video Wall" selected.
- 5**: A slider control is visible in the top right.
- 6**: A dashed orange box highlights the 2x2 grid of video wall panels, each containing a "SELECT OTHER RX" dropdown menu.
- 7**: The "Video Ratio" section shows two icons representing different video ratios.
- 8**: The "Save" button is highlighted in green.

1. Define the name for this video wall. The limitation is up to 30 characters, no special characters allowed.
2. Enter the number of the display monitors belong to this video wall, and select the display orientation.
3. Set the bezel (the borders around the screen) in millimeter.
4. Select an operation mode for your video wall.

Layout	Description
Video Wall	Set up a video wall.
Splitter	Set up a display of identical content on multiple monitors.
Customize	<p>Select to create a custom display layout.</p> <p>Note:</p> <ul style="list-style-type: none"> ◆ The limitation for a customized layout name is up to 30 characters, no special characters allowed. ◆ A maximum of 32 customized layouts (excluding video wall and splitter layouts) is supported.

5. Optionally use the zoom slider to change the zoom level of the layout preview, and use the zoom to fit button to automatically resize the layout preview to fit the preview area in this popup window.
6. The layout preview help you visualize the configurations. From the drop-down menu, select the output receiver for each display monitor.
7. Select either **full** or **natural** for the display mode. When using a customized layout, choose **merge** or **separate** to arrange the monitors.

Item	Description
 full	Click to display the source video in full extension across the selected screen.
 natural	Click to display the source video in its original aspect ratio.
 merge	Click to merge selected monitors from the layout preview into a single display.

	Item	Description
	separate	Click to split previously merged monitors. Select a merged monitor from the layout preview and click this button.

- Click on **Save** button to create a video wall while **Cancel** to discard the settings.
- The successfully-created video wall is now on the room arrangement area. You can edit its displayed content by dragging the video from Tx source list and media list. See *Assigning Sources*, page 75 for details.

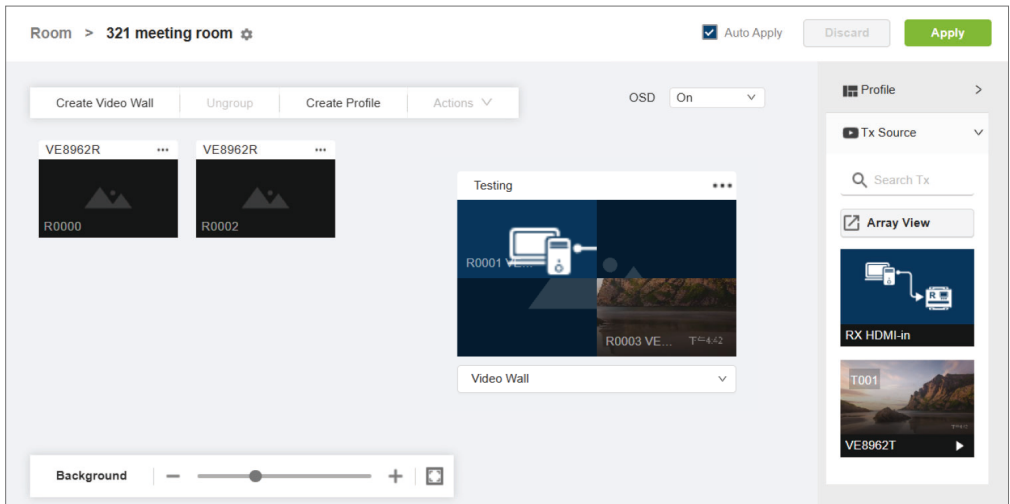

Note: The system supports a maximum of 32 video walls, with each video wall accommodating up to 256 receivers (for example, a 16 × 16 configuration).

Ungroup

To ungroup a video wall, do the following:

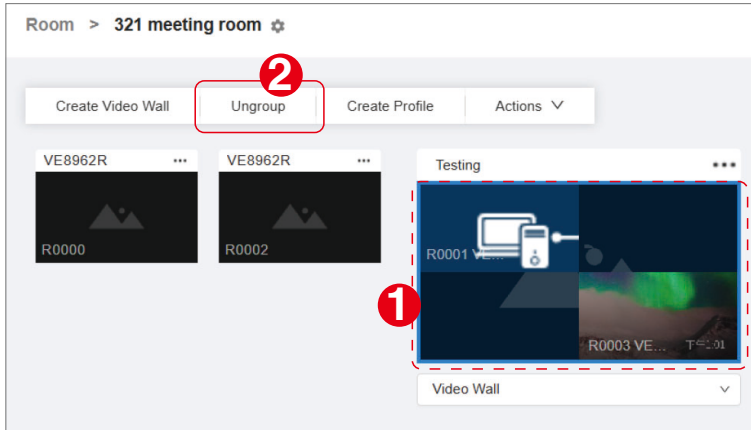

1. Select an existing video wall you'd like to ungroup.
2. Click the **Ungroup** button on the toolbar.
3. The video is now decomposed into receivers.

Create Profile

Click **Create Profile** button to save your current configuring video receiver / video wall settings to be a profile.

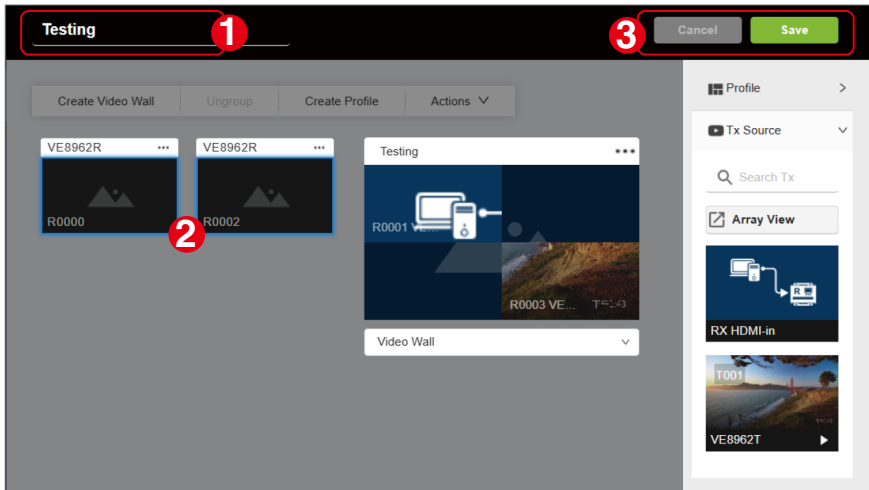

1. Enter a name for the profile to be created.
2. Click to select the receiver(s) / video wall(s).
3. Click **Save** to create a new profile while **Cancel** to discard changes.
4. Click to unfold the profile list and you'll find the newly-created profile is listed.

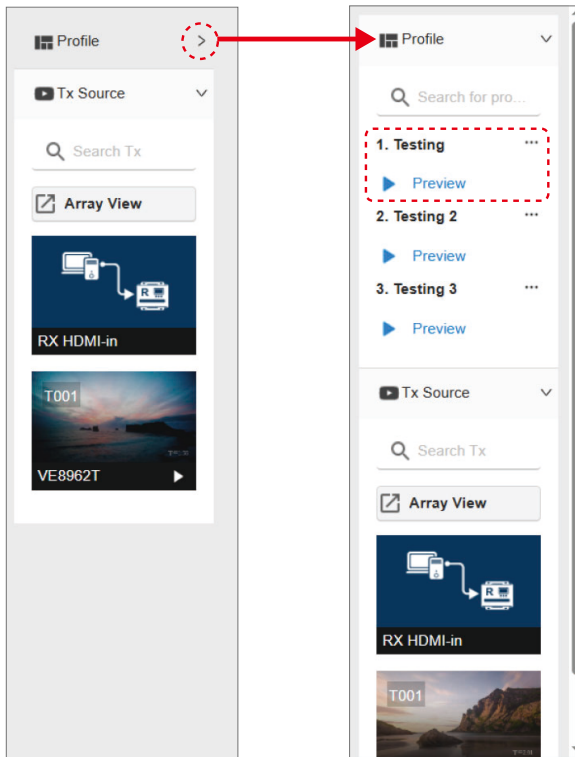

For more profile operations, please refer to *Profile Management*, page 79.

Actions

Actions menu is available once the existing receiver / video wall card(s) is selected. The options are:

The screenshot shows a web interface for a meeting room named "321 meeting room". At the top, there are four buttons: "Create Video Wall", "Ungroup", "Create Profile", and "Actions". The "Actions" button is open, showing a dropdown menu with the following options: "Blank Selected Rx", "Unblank Selected Rx", "Disconnect Current Source", and "Move to". Below the buttons, there are three video wall cards. The first two are labeled "VE8962R" and "R0000". The third is labeled "Testing" and "R0001". The "Move to" option in the menu has a right-pointing arrow, indicating it leads to another menu.

Item	Description
blank selected Rx	Disables the monitor display content of the selected target receiver, and the monitor screen of the target(s) goes blank.
unblank selected Rx	Enable the blanked monitor display of the selected target receiver.
disconnect current source	Disconnect the source video from the transmitter.
move to	Move the target(s) to other room. The available rooms is on the next option menu.

Background Settings

The background settings tool offers the following functions:

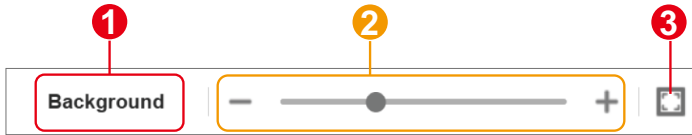

1. background image settings

Click to open the setting menu to set a background image for this room, such as a site layout, to help locate the device(s).

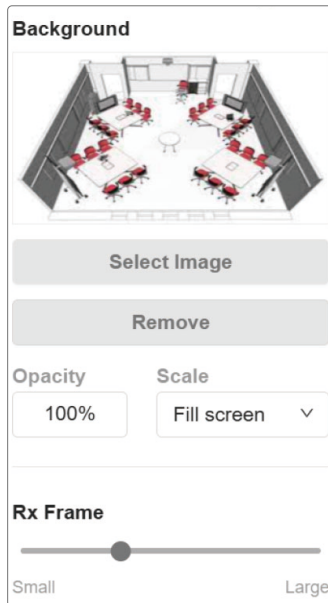

Item	Description
thumbnail preview	Shows the small image representation of the current / selected background image.
select image	Selects an image to be uploaded as the room background image. Upload a .jpg or .png file up to 5MB; resolution is not restricted.
remove	Deletes the background image.
opacity	Defines the background image opacity-level by percentage.

Item	Description
scale	Choose a fit for the background image. <ul style="list-style-type: none"> ◆ Fill Screen: Makes the background image fit the entire room arrangement area. ◆ Fit Height: Fits the background image to the height of the room arrangement area. ◆ Fit Width: Fits the background image to the width of the room arrangement area.
Rx frame slider	Drag the slider to change how the receiver and video wall cards are scaled on screen.

2. zoom slider

Use the zoom slider to change the zoom level of the room arrangement area as well as the receiver / video wall card(s) on it.

3. zoom to fit

Use the zoom to fit button to automatically resize the arrangement area and the card(s) on it.

Receiver / Video Wall Management

The receiver(s) and the video wall(s) are presented as cards on the room arrangement area as the figures show below:

◆ Receiver

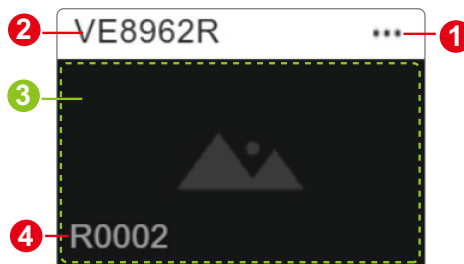

No.	Item	Description
1	more button	Click on the more button to open the configuration menu for more operations. See <i>Configuration Menu</i> , page 75 for details.
2	model name	Displays the model name.
3	preview	Represents the video content on the receiver.

No.	Item	Description
4	connected Rx ID	Shows the receiver ID.

◆ **Video Wall**

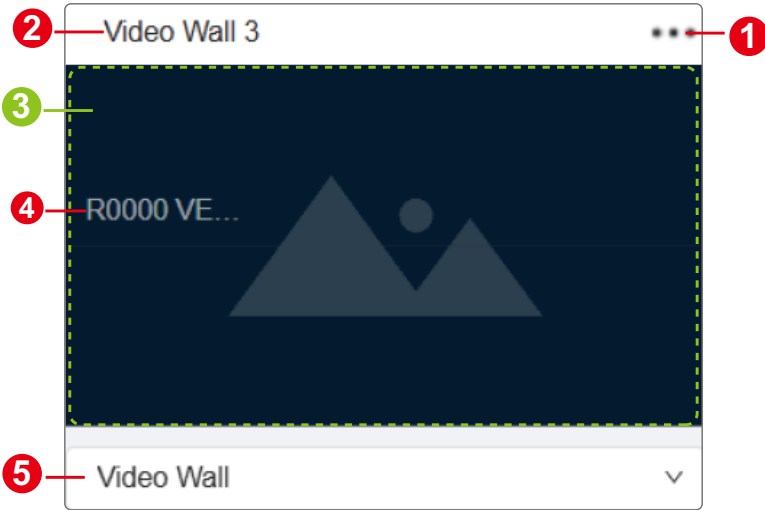

No.	Item	Description
1	more button	Click on the more button to open the configuration menu for more operations. See <i>Configuration Menu</i> , page 75 for details.
2	video wall name	Displays the name you set when creating the video wall.
3	preview	Represents the video content on the video wall.
4	connected Rx ID	Shows the receiver ID(s).
5	operation mode	<p>Select an operation mode for your video wall.</p> <ul style="list-style-type: none"> ◆ Video Wall: Select this option to set up a video wall. ◆ Splitter: Select this option to set up a display of identical content on multiple monitors. ◆ Customize: Select to apply a custom display layout.

Assigning Sources

Follow the steps below to assign input sources:

1. Identify the source to be assigned on the transmitter source list and the target receiver / video wall.
2. Select and drag the source video to the preview area of the target receiver / video wall.

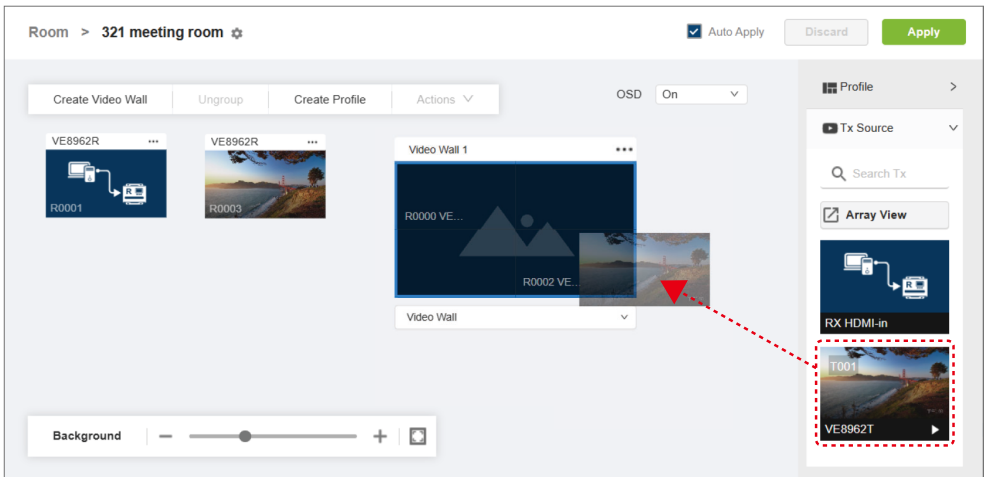

Configuration Menu

Click on the more button of the receiver / video wall card(s) to open the configuration menu for the following operations:

- ◆ Receiver

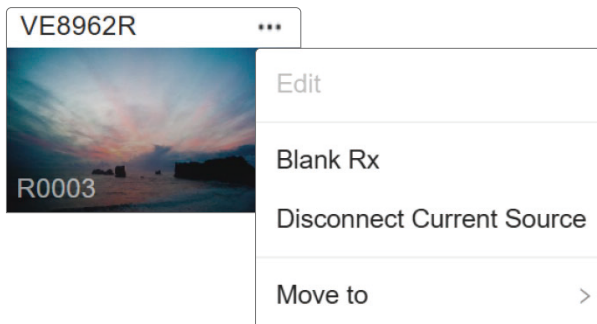

Item	Description
Edit	Open the edit popup and make changes of this receiver.
Blank Rx / Unblank Rx	Enable or disable the blanked monitor display of this receiver.
Disconnect Source	Disconnect the source video from the transmitter.
Move to	Move this receiver to other room. The available rooms is on the next option menu.

◆ Video Wall

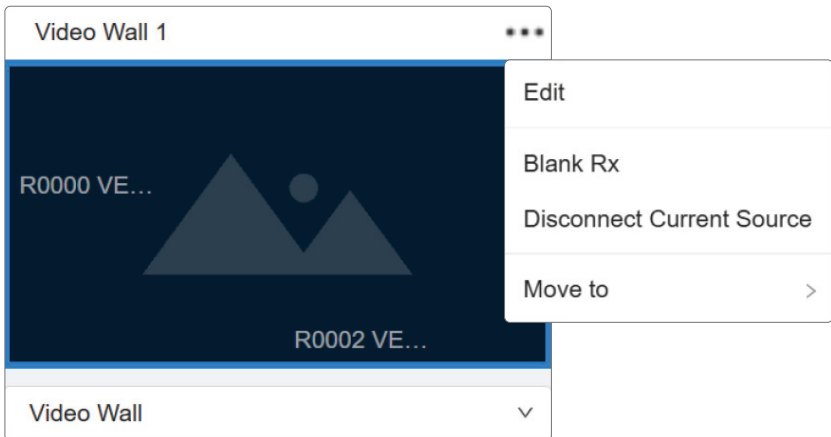

Item	Description
Edit	Open the Create Video Wall popup to make changes. See <i>Create Video Wall</i> , page 66 for details.
Blank Video Wall/ Unblank Video Wall	Enable or disable the blanked monitor display of this video wall.
Disconnect Source	Disconnect the source video from the transmitter.
Move to	Move this video wall to other room. The available rooms is on the next option menu.

Source Panel Control

The source panel is located on the right side of a room. It contains the Profile list and the Tx source list. This section explains how to use the Tx source list. For details on the Profile list, refer to *Profile Management*, page 79.

Tx Source List

The Tx source list consists of three parts: the search bar, the transmitter list, and the array preview.

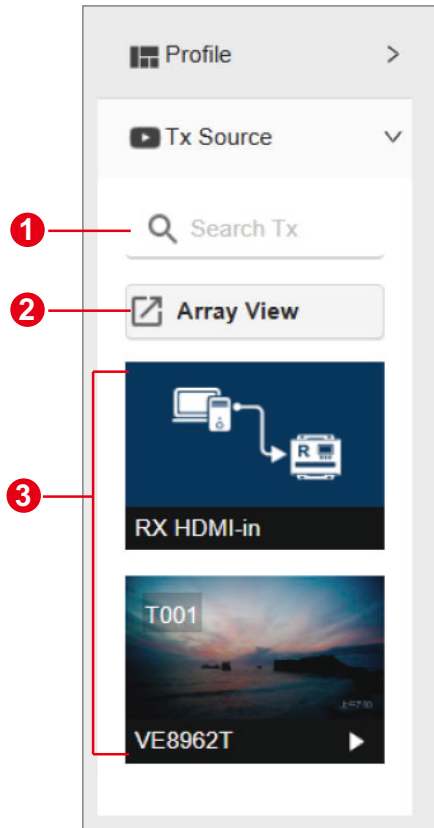

No.	Item	Description
1	Search bar	Enter the device ID or device name to search for a specific transmitter.

No.	Item	Description
2	Array View	Opens a window to view all granted transmitters for this room.
3	transmitter list	Displays the granted transmitters for this room.

The video thumbnail preview in the transmitter list and Array View window displays a live video preview. Assign the video source by dragging the transmitter's video preview in transmitter list to the target receiver or video wall. Release to complete the assignment.

The **Array View** window displays all videos from the granted transmitters, providing an overview of all video sources along with the transmitter's ID, device name, and IP address.

The screenshot shows the 'Array preview' window. At the top, there is a search bar with the placeholder text 'Search ID, Device Name, IP'. To the right of the search bar, there are controls for 'Items per page' (set to 16) and 'Page' (set to 1 of 60). The main area of the window is a 4x4 grid of 16 video thumbnails. Each thumbnail shows a live video feed of a baseball game in progress. In the top left corner of each thumbnail, the transmitter ID 'T001' and IP address '192.168.2.4' are displayed. In the bottom left corner of each thumbnail, the device name 'Device name123456789000' is displayed. The window has a blue header with the title 'Array preview' and a close button (X) in the top right corner.

Profile Management

After configuring video receiver / video wall settings, if you find that you would like to keep the current settings, you can save it as a profile. You can create different profiles and apply them manually, or you can set up profile schedules for switching video display at different times of a day, week or month.

Creating a Profile

Follow the steps below to create a profile.

1. In the room's arrangement area, click the **Create Profile** button on toolbar. The profile configuration screen will appear.
2. On the profile configuration screen:

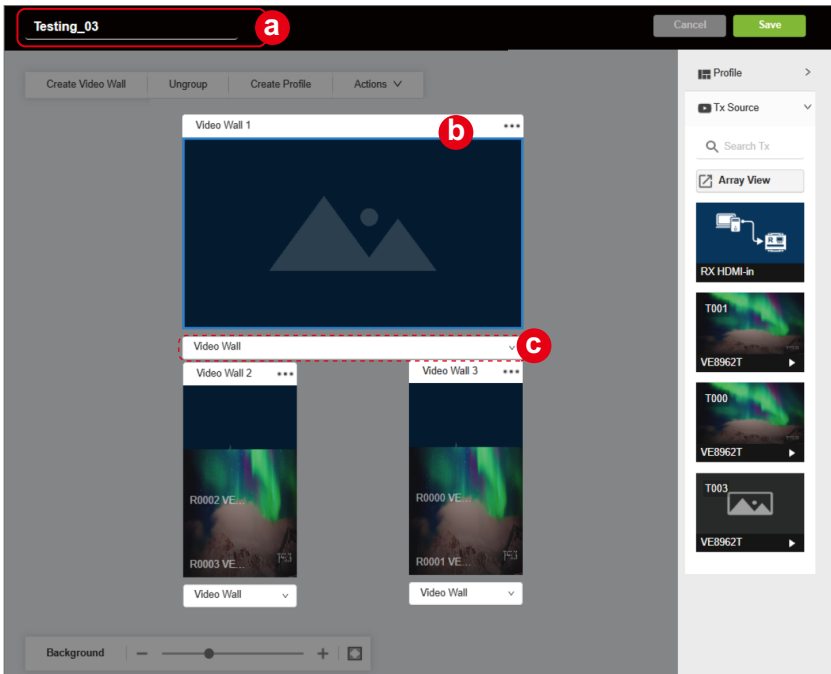

- a) Enter a name for the profile. A profile name can contain up to 30 characters, and must not include any special symbols from the restricted list. The system supports a maximum of 32 profiles.
- b) Click to choose the receiver(s) / video wall(s) you wish to be in this profile.

- c) (optional) Change the operation mode if needed.
3. Click **Save** to complete the configuration.
4. The profile you just created will now appear in the profile list.

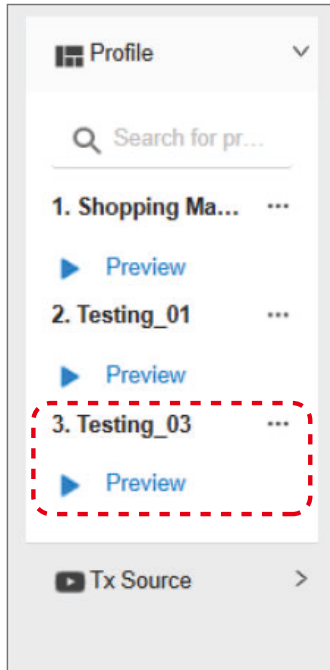

-
- Note:**
- ♦ A profile becomes invalid if its receiver(s) or video wall(s) are lost or deleted.
 - ♦ A failed attempt to create a new profile may be due to the receiver / video wall not having a video source from transmitters or HDMI local input.
-

Editing or Deleting a Profile

To edit or delete an existing profile, do the following:

1. From the profile list, click the more button to open the option menu.

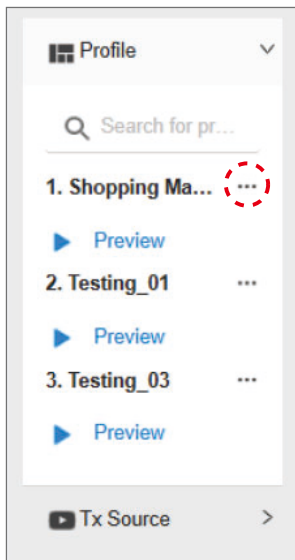

2. Select the function you'd like to proceed with.

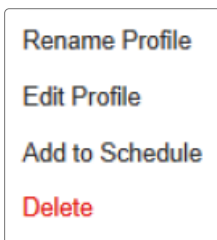

Item	Description
Rename Profile	Edit the profile name.
Edit Profile	Open the profile configuration screen to make changes.
Add to Schedule	Set the schedule for when the profile will be played. See <i>Setting Up Profile Schedules</i> , page 82.
Delete	Remove this profile. The system will ask if you would like to delete this profile. Click Delete to proceed or click Cancel to cancel.

Setting Up Profile Schedules

Follow the steps below to set up profile schedules:

1. In the profile list, locate the desired profile and click its more button to open the options menu.
2. Select **Add to Schedule** to open the **Add Schedule** popup.

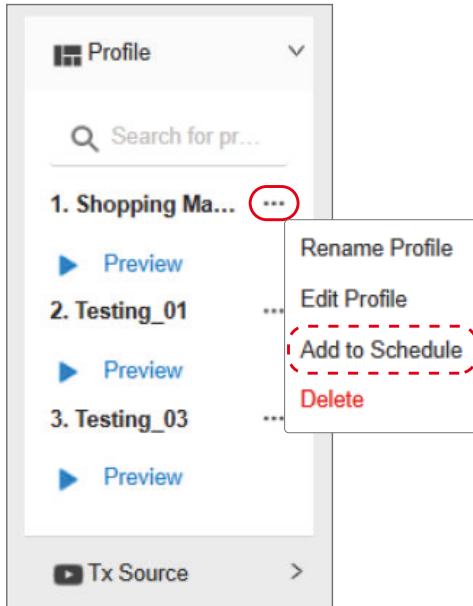

3. Configure the schedule as needed:

Add Schedule [X]

Profile

Shopping Mall Schedule [v] [Color Selection]

Time

Start Time: 2025/08/11 [Calendar] 19:48 [Clock] to 19:58 [Clock]

All Day

Repeat: Never [v]

Status On

Cancel Save

- ◆ **Profile:**
Select the profile to be added to the schedule..
- ◆ **Color Code:**
Assign a color label to this task. Use different colors to distinguish tasks.
- ◆ **Start Time / End Time:**
Define the start and end times for the task.
- ◆ **Repeat:**
Select a repeat cycle for the schedule.
- ◆ **Status:**
Enable or disable the scheduled task.

Note: For detailed settings, please refer to *Schedule*, page 89.

4. Click **Save** to save the schedule.

Matrix

The **Matrix** page provides a centralized interface for managing and controlling signal routing between transmitters and receivers. It supports audio, USB, IR, and RS-232 signal types, allowing flexible configuration to meet diverse application needs. From this page, you can patch signals between specific devices, mute selected channels, or synchronize settings across multiple endpoints. The intuitive layout makes it easy to monitor active routes, adjust configurations in real time, and ensure smooth, coordinated operation of all connected devices.

Audio

The **Audio** tab page offers the following functions:

The screenshot shows the Matrix Audio configuration page. At the top, there are tabs for 'Audio', 'USB', 'IR', and 'RS-232'. To the right of these tabs are a checked 'Auto Apply' checkbox and a green 'Apply' button. Below the tabs are 'Mute All' and 'Unmute All' buttons. The main area is divided into 'Transmitter' and 'Receiver' sections. The 'Receiver' section has a table with columns R000, R001, R002, and R003, each containing a speaker icon and a green checkmark. The 'Transmitter' section has a table with rows T000, T001, and T003, each containing a radio button, a 'Follow Video Path' checkbox (highlighted with a red dashed box), and a speaker icon. A table below the transmitters shows routing connections between transmitters and receivers.

Transmitter		Receiver			
		R000	R001	R002	R003
		VE8962R	VE8962R	VE8962R	VE8962R
<input checked="" type="checkbox"/>	Follow Video Path				
<input type="radio"/>	T000 - VE8962T				
<input type="radio"/>	T001 - VE8962T				
<input type="radio"/>	T003 - VE8962T				

Numbered callouts in the image point to the following elements:

- 1: Mute All button
- 2: Unmute All button
- 3: Auto Apply checkbox
- 4: Apply button
- 5: Follow Video Path checkbox
- 6: Radio button for T000
- 7: Mute icon for T000
- 8: Volume icon for T000
- 9: Speaker icon for R003
- 10: Green checkmark for R003

No.	Item	Description
1	Mute All	Mute all the transmitters and receivers.
2	Unmute All	Unmute all the muted VE8962 units.
3	Auto Apply	Apply the changes automatically.
4	Apply	Click Apply to save your changes.
5	Follow Video Path	Set the audio follow the same routing as the video signal.
6	select all	Click to select all the receivers to obtain the audio signal from this transmitter.
7	HDMI	Select the audio source between HDMI and Stereo . The default setting is HDMI.
8	Stereo	
9	mute / unmute	Click on the button to mute or unmute the unit.
10	crosspoint	On the graphical crossbar, simply click a crosspoint to enable the signal routing path. To disable it, click the selected crosspoint again to unmark it.

USB

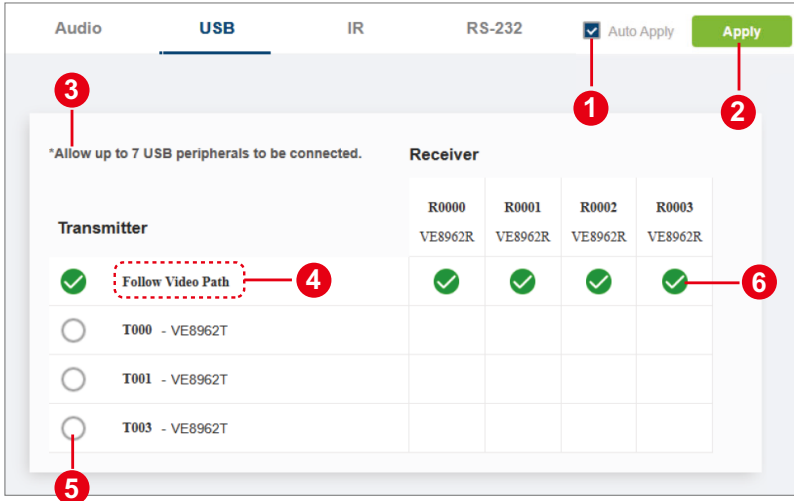

No.	Item	Description
1	Auto Apply	Apply the changes automatically.
2	Apply	Click Apply to save your changes.
3	note	Supports up to seven connected USB peripherals.
4	Follow Video Path	Select this option to receive USB signals from the transmitter (Connected Tx) where the receiver obtains its video source. Note: <ul style="list-style-type: none"> ◆ The Boundless Switch function is scheduled to be enabled starting from the R1 firmware release. ◆ When Boundless Switch is enabled, the entire Rx column becomes disabled and is automatically set to Follow Video Path, ensuring USB patching follows the video signal.
5	select all	Click to select all the receivers to obtain the USB signal from this transmitter.
6	crosspoint	On the graphical crossbar, simply click a crosspoint to enable the signal routing path. To disable it, click the selected crosspoint again to unmark it.

IR / RS-232

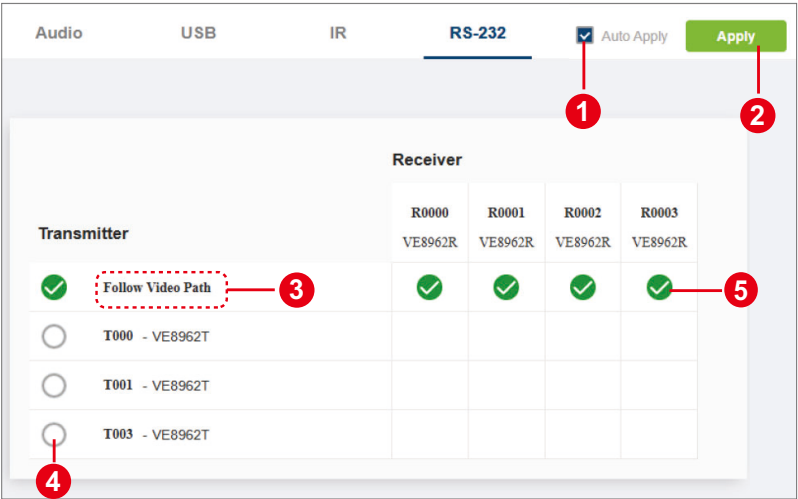
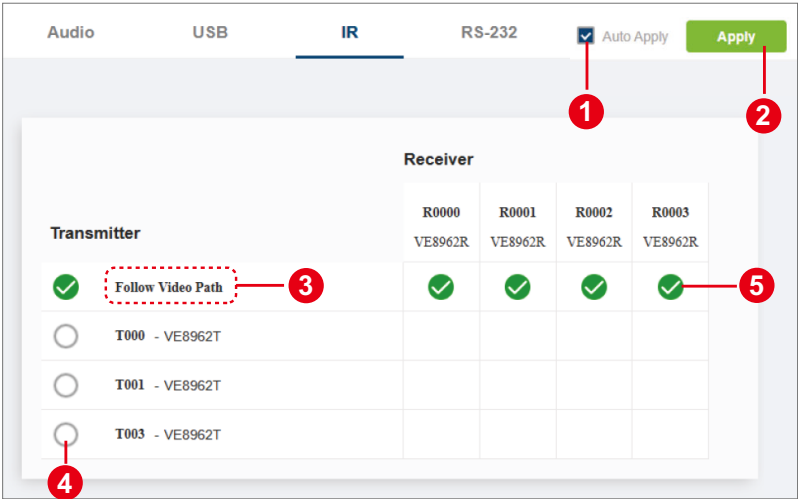



No.	Item	Description
1	Auto Apply	Apply the changes automatically.

No.	Item	Description
2	Apply	Click Apply to save your changes.
3	Follow Video Path	Select this option to receive IR / RS-232 signals from the connected transmitter that supplies the receiver's video source.
4	select all	Click to select all the receivers to obtain the IR / RS-232 signal from this transmitter.
5	crosspoint	On the graphical crossbar, simply click a crosspoint to enable the signal routing path. To disable it, click the selected crosspoint again to unmark it.

Schedule

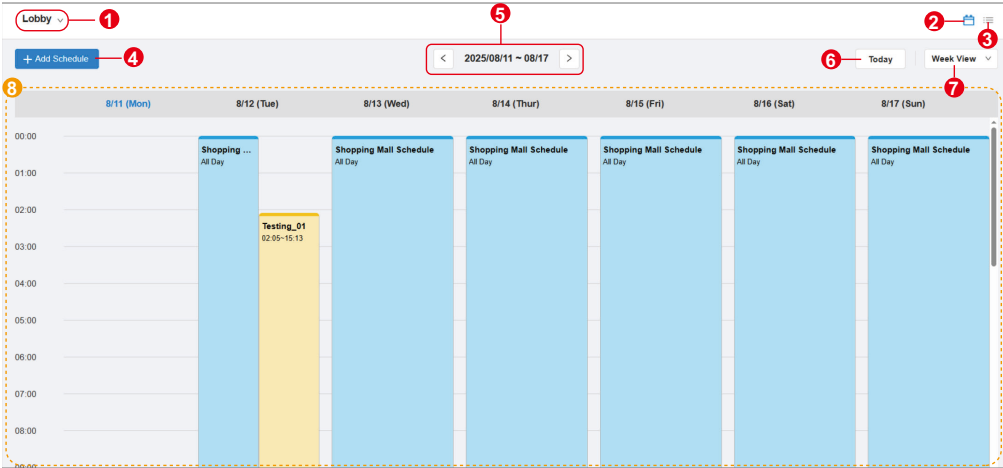
Schedule helps you to set up tasks that perform automatically on specific days and times. The system supports a maximum of 32 schedules.



No.	Item	Description
1	room selection	Click to expand the drop-down menu that lists all the room options. Select the room you'd like to manage to switch to its schedule.
2	timeline view	Visualizes the timing and duration of the tasks.
3	list view	Displays the scheduled tasks as a list.
4	add schedule	Click to create a new scheduled task to be performed in this room.
5	date picker	Use the next button  or the previous button  to select the date / the range of dates: <ul style="list-style-type: none"> ◆ in day view: Select the date to display the task(s) to be performed on the day. ◆ in week view: Select the range of dates by week to display the task(s) to be performed within the week.
6	go to today button	Click on the today button to go back to today or the current week.

No.	Item	Description
7	schedule view selection	Choose between week view and day view to display the task calendar / task list.
8	task calendar / task list	Shows the scheduled task(s) to be performed in this room during the selected week.

Create a Scheduled Task

To create a scheduled task, do the following:

1. Open a room schedule from the room selection menu on schedule page.
2. Click on the + **Add Schedule** button to open the add schedule window.

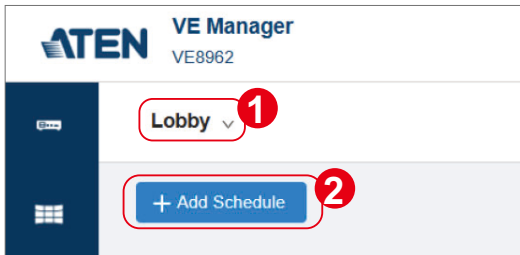

3. Define the following settings:

The 'Add Schedule' dialog box has a dark blue header with the title 'Add Schedule' and a close button (X). The settings are as follows:

- Profile:** A dropdown menu set to 'Testing_01' and a blue toggle switch.
- Time:** 'Start Time' is set to '2025/08/11' with a calendar icon, '00:00' with a clock icon, 'to', '23:59' with a clock icon.
- Repeat:** An 'All Day' checkbox is unchecked. The 'Repeat' dropdown is set to 'Daily'.
- End Recurring Task:** Radio buttons for 'Never' (selected) and 'On' are present. The 'On' option is followed by a date field '2025/08/11' and a calendar icon.
- Status:** A blue toggle switch is turned 'On'.

At the bottom right, there are 'Cancel' and 'Save' buttons.

Item	Description																																										
select Profile	Select a profile for this task to play. See Profile Management for how to manage the profiles.																																										
color-code	Assign a color label to this task. Use different colors to tell the tasks apart.																																										
start time / end time	Sets the date and time the task will begin and end.																																										
all day	Check the All Day checkbox to play this task all day long.																																										
repeat	<p>Performs the task repeatedly at the scheduled times. The options to run the recurring task are:</p> <ul style="list-style-type: none"> ◆ never: The task is executed only one time. ◆ daily: The recurring task is executed everyday. ◆ weekly: The recurring task is executed on a weekly basis. By selecting weekly, you need to further specify the days of the week that the task is run. <div data-bbox="405 783 953 914" style="border: 1px solid black; padding: 5px; margin-bottom: 10px;"> <p>Repeat Weekly ▾</p> <table border="1" style="width: 100%; text-align: center; border-collapse: collapse;"> <tr> <td style="background-color: #003366; color: white;">Mon.</td> <td>Tue.</td> <td>Wed.</td> <td>Thur.</td> <td style="background-color: #003366; color: white;">Fri.</td> <td>Sat.</td> <td>Sun.</td> </tr> </table> </div> <ul style="list-style-type: none"> ◆ monthly: The recurring task is executed on a monthly basis. Set the particular dates this task recurs. <div data-bbox="405 1031 953 1358" style="border: 1px solid black; padding: 5px;"> <p>Repeat Monthly ▾</p> <table border="1" style="width: 100%; text-align: center; border-collapse: collapse;"> <tr> <td>1</td><td>2</td><td>3</td><td>4</td><td>5</td><td>6</td><td>7</td> </tr> <tr> <td>8</td><td>9</td><td>10</td><td>11</td><td>12</td><td>13</td><td>14</td> </tr> <tr> <td>15</td><td>16</td><td>17</td><td>18</td><td>19</td><td>20</td><td>21</td> </tr> <tr> <td>22</td><td>23</td><td>24</td><td>25</td><td>26</td><td>27</td><td>28</td> </tr> <tr> <td>29</td><td>30</td><td>31</td><td colspan="4"></td> </tr> </table> </div>	Mon.	Tue.	Wed.	Thur.	Fri.	Sat.	Sun.	1	2	3	4	5	6	7	8	9	10	11	12	13	14	15	16	17	18	19	20	21	22	23	24	25	26	27	28	29	30	31				
Mon.	Tue.	Wed.	Thur.	Fri.	Sat.	Sun.																																					
1	2	3	4	5	6	7																																					
8	9	10	11	12	13	14																																					
15	16	17	18	19	20	21																																					
22	23	24	25	26	27	28																																					
29	30	31																																									

Item	Description
end repeat	<p>Sets the due date for this task. This setting is only available when Repeat is set as daily or weekly or monthly.</p> <ul style="list-style-type: none"> ◆ Never: Enable this option to continue repeating indefinitely. ◆ Invalid date: Sets the date that the task will no longer run.
status	Click on the switch to turn on or off the task.

- Click the save button to finalize creating the task. Now you can find the task you just created is on the task list.

Scheduled Tasks Management

To edit an existing task, find the task you'd like to edit from the task list, and double-click on the task to open the **Edit Schedule** popup.

Edit Schedule ✕

Profile

Testing_01
▼
●
▼

Time

Start Time 2025/08/12 📅 02:05 🕒 to 15:13 🕒

All Day

Repeat Never ▼

Status 🔘 On

Delete
Cancel
Save

Through **Edit Schedule** popup, you may:

- ◆ Make changes of this task and save it.
- ◆ Remove this task from the task list by clicking **Delete** button.
- ◆ Turn on or off the status switch to make this task active or inactive.

User

The **User** page provides administrators with the tools to create, edit, and manage accounts, assigning each with specific access levels to system functions. Two user roles are available: **Administrator**, with full control and editing rights across all rooms and pages, and **User**, with limited access to only the rooms assigned by an administrator. This structure ensures secure and efficient management of system access while accommodating different operational needs.

The **User** page lets the account with administrator role do the following:

- ◆ Check, add, edit, or delete users.
- ◆ Change the account password for accessing the VE Manager.
- ◆ Assign the user role to the user account.

Types of User Roles

VE Manager offers two user roles with different levels of authority. When creating an account, an administrator can assign the role as either **Administrator** or **User**.

Refer to the tables below to distinguish between account authorization levels.

User Role	Access Permissions					
	Device	Room	Matrix	Schedule	User	Maintenance
User		✓		✓		
Administrator	✓	✓	✓	✓	✓	✓

Note: The account with the **User** role has limited access to the room(s) assigned by an administrator.

User Account Management

The **User** page is accessible only to administrator accounts. To create, edit, or remove user accounts, you must log in to VE Manager with an administrator account.

- ◆ Up to 99 accounts can be created, including the default administrator account.
- ◆ The default administrator account cannot be deleted.

Creating a New User Account

To create a new user account, follow these steps:

1. On the **User** page, click the **Add User** button to open the **User Management** popup.

The screenshot shows a modal window titled "Add User" with a close button in the top right corner. The form contains the following elements:

- Username:** A text input field with the placeholder text "Username".
- Password:** A text input field with the placeholder text "Password".
- Confirm Password:** A text input field with the placeholder text "Confirm Password".
- User Type:** Two radio buttons labeled "Administrator" and "User". The "User" radio button is selected.
- Room Access Permission:** A section with two boxes labeled "Available" and "Selected". Between the boxes are two arrow buttons: a right-pointing arrow (>) and a left-pointing arrow (<).
- Buttons:** "Cancel" and "Save" buttons are located at the bottom right of the modal.

2. Define the username and password, and specify the user type.
 - ◆ Usernames and passwords must be 5–16 alphanumeric characters excluding the following symbols:
: ; = [] + / ? \.
 - ◆ Passwords are case-sensitive.
 - ◆ Usernames support lowercase letters only.

- Configure the account's access permissions for the room(s).

Note: Administrators have access to all rooms, while **Users** have limited access to the assigned rooms.

- Click **Save** to create the new account. Click **Cancel** to abort the creation and close the popup.

Deleting an Existing User Account

To remove an existing account(s):

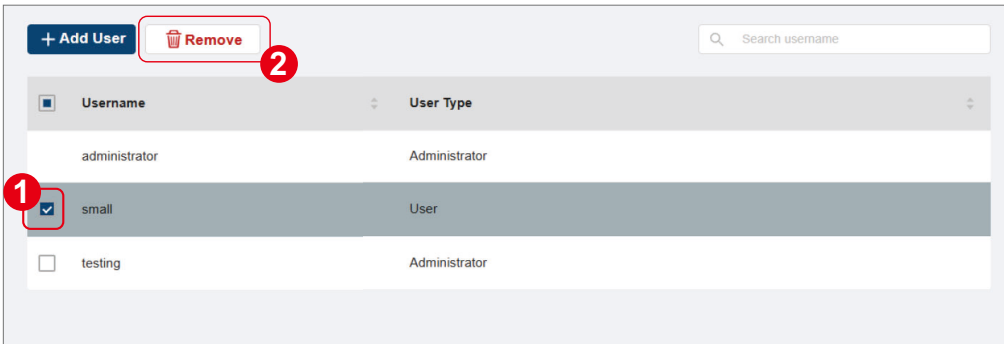

- From the user account list, select the account(s) you'd like to delete.
- Click the **Remove** button to delete the selected account(s).

Note: An administrator account cannot delete its own entry from the user list. For this reason, the checkbox for the logged-in administrator's account is hidden in the list.

Editing an Existing User Account

To edit an existing account:

- From the user account list, double-click on an account to open the account's **User Management** popup.
- Make the necessary changes and save.

Maintenance

The **Maintenance** page allows you to specify device date and time, configure settings of connected VE8962 devices, upgrade device firmware, and back up the VE Manager's settings.

General Settings

The **General** tab contains the date, time, panel lock settings, and CLI settings.

Maintenance

Discard Save

General Firmware Update Backup & Restore

Date / Time

Date & Time

Sync with Computer Time

Preference

Disconnected View ATEN Logo Monitor's No Signal Screen Black Screen

Panel Lock Never Auto Lock

CLI

Login Off On

Timeout

CLI Protocol SSH only SSH + Telnet

Account Lockout Policy

Account Lockout Enable Disable

Maximum Invalid Login Attempts

Make sure to save your changes by clicking **Apply** button.

Date & Time

Settings	Description
Date & Time	Set the date and time from the date picker and time picker. Note: The function is only available when Manual mode is enabled.
Sync with Computer Time	If you wish to synchronize the time with the computer's time, click the button to process the settings.

Preference

Settings	Description
Disconnection View	Set the screen to be displayed when input video source is disconnected.
Panel Lock	Select Auto Lock to lock the panel control of all the VE8962 units.

CLI

Settings	Description
Login	Select On to enable remotely logging in to VE8962 from a computer using RS-232 / Telnet interface.
Timeout	Specify the idle time that causes the CLI session closed.
CLI Protocol	Select the protocol(s) for Command Line Interface access: <ul style="list-style-type: none"> ◆ SSH only: Restricts CLI access to the SSH protocol. ◆ SSH + Telnet: Allows CLI access through both SSH and Telnet protocols.

See *CLI Commands*, page 139 for details.

Account Lockout Policy

Settings	Description
Account Lockout	Enables or disables the feature that locks a user account after a specified number of failed sign-in attempts.
Maximum Invalid Login Attempts	Specifies the maximum number of failed sign-in attempts allowed before the account is locked.
Account Lockout Duration (mins)	Defines the number of minutes a locked account remains inaccessible before it is automatically unlocked.

Set as Primary Device & Sync to All Other Devices

Click the button Implement to set the currently logged-in device as the primary controller and synchronize its settings to all other devices.

SSL Certificate

Use this section to upload an SSL certificate and its corresponding private key for secure HTTPS communication.

System Log

This feature lets you download the System Log as a text file (.txt) for review. The log records key events such as system startups, authentication activities, and firmware operations (dispatch, upload, upgrade, completion, etc.), including time stamps and relevant device identifiers for troubleshooting and audit purposes.

Firmware Upgrade

To upgrade the VE8962 device firmware, follow the steps below.

The screenshot shows the 'Maintenance' section with the 'Firmware Update' tab selected. At the top, there are three tabs: 'General', 'Firmware Update', and 'Backup & Restore'. Below the tabs is a form with a text input field labeled 'Select firmware file', a 'Browse' button, and an 'Update' button. A table below the form lists devices with columns for ID, Device Name, IP, Firmware, and Status. A red box highlights the checkboxes in the ID column, and red circles with numbers 1, 2, and 3 point to the checkboxes, the 'Browse' button, and the 'Update' button respectively.

<input type="checkbox"/>	ID	Device Name	IP	Firmware	Status
<input type="checkbox"/>	R0000	VE8962R	169.254.0.100	V1.0.092	
<input type="checkbox"/>	T000	VE8962T	169.254.0.200	V1.0.092	
<input type="checkbox"/>	T001	VE8962T	169.254.0.201	V1.0.092	
<input type="checkbox"/>	R0001	VE8962R	169.254.0.101	V1.0.092	
<input type="checkbox"/>	R0002	VE8962R	169.254.0.102	V1.0.092	
<input type="checkbox"/>	R0003	VE8962R	169.254.0.103	V1.0.092	
<input type="checkbox"/>	T003	VE8962T	169.254.0.203	V1.0.092	

1. Select the device(s) you'd like to upgrade the firmware.
2. Click the **Browse** button to find the firmware file in your PC.
3. Click **Update** to start the upgrade process.

Back Up & Restore

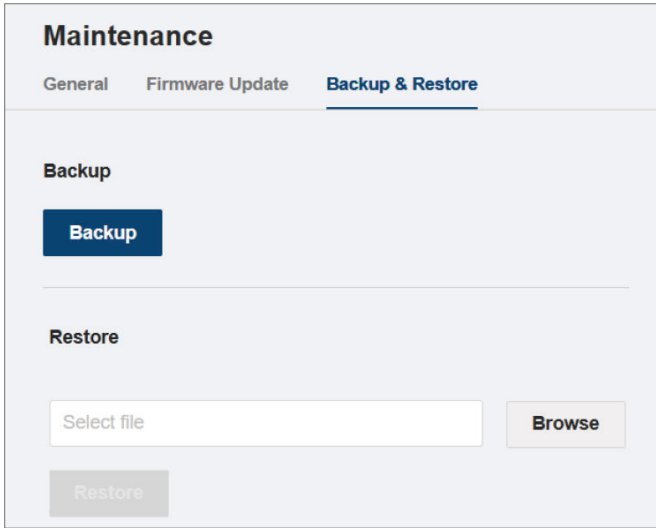

The screenshot shows a web interface titled "Maintenance" with three tabs: "General", "Firmware Update", and "Backup & Restore". The "Backup & Restore" tab is active. Under the "Backup" section, there is a blue button labeled "Backup". Under the "Restore" section, there is a text input field labeled "Select file", a "Browse" button, and a "Restore" button.

Backup is to save to a copy of system configurations and restore is to load a previously saved backup file to recover system configurations.

- ◆ To restore settings from a backup file, the number of devices, their Tx/Rx modes, and MAC addresses must match those in the backup.
- ◆ Network settings (IP address and subnet mask) will not be restored.
- ◆ Once the restore process is complete, all units will reboot.

Chapter 5

CLI Commands

Overview

Before executing any CLI commands, access and authentication ensure that only authorized users can operate the VE8962 system. The Command Line Interface (CLI) is available exclusively through receivers and requires an administrator account for login. This section introduces the supported access methods, the login sequence, and the proper way to exit a session.

Access and Authentication

Make sure you have installed a PC or an ATEN Control Box to the Ethernet switch in your setup. Logi in to VE Manager and go to **Maintenance > CLI**. Select **On** to enable remotely logging in to VE8962 from a computer using RS-232 / Telnet interface.

The VE8962 Command Line Interface (CLI) can be accessed only by accounts with the administrator role.

Access Methods

- ◆ SSH (Port 22):
Connect to a receiver with encrypted communication.
- ◆ Telnet (Port 23):
Connect to a receiver with plain-text communication.
- ◆ RS-232:
Connect through the serial interface when set to CLI mode.

Note: CLI sessions are available through receivers (Rx) only.

Login and Exit

When a session starts, the system displays “Welcome to CLI mode”. Enter the administrator password to authenticate.

To exit, type `exit` to end the session and close the connection.

Command Guidelines

- ◆ The general form of a command is:

command parameter<argument> {one|two|three}

Notation	Description
command	The name of the command is shown in bold.
parameter	Indicates the name of the parameter.
<argument>	Indicates the name of the value or the information that the user must provide. Only type the information in the angle brackets, not the brackets themselves.
[]	Indicates keys you should press. For example, [Enter] means to press the Enter key. If keys need to be chorded, they appear together in the same bracket with a plus sign between them: [Ctrl+Alt].
{ }	Indicates a set of choices from which the user must choose one.
	Indicates two or more mutually exclusive choices in a command line. Only type one of the choices in the command line, not the symbol.

- ◆ If you have two or more parameters, the order of these parameters among themselves does not affect the result of the operation. For example, both of the following commands execute the same task:

command name + parameter 1 + parameter 2

command name + parameter 2 + parameter 1

Command Format and Fields

The VE8962 Command Line Interface (CLI) follows a consistent structure to ensure clear syntax and predictable behavior. Each command is composed of a command keyword, followed by one or more fields (parameters), and ends with an action or control option.

Command Structure

- ◆ The general form of a command is:

```
command [fields] [controls]
```

- ◆ **command:**

A reserved keyword that specifies the operation (e.g., `sw`, `mute`, `reboot`).

- ◆ **fields:**

Identifiers or parameters that indicate the target device(s), such as a transmitter, receiver, or video wall.

- ◆ **controls:**

Action flags that define the command's intended behavior (e.g., `on`, `off`, `all`).

- ◆ **Example:**

```
sw i192.168.1.100 o192.168.1.101 on
```

In this example, `sw` is the command keyword, `i192.168.1.100` and `o192.168.1.101` are fields, and `on` is the control.

Field Formats

Each field uses a prefix to identify its type, followed by a specific value (Panel ID, IP address, or MAC address).

- ◆ **i*:**

Input source (transmitter)

Accepts Panel ID, IP address, or MAC address.

- ◆ **o*:**

Output target (receiver)

Accepts Panel ID, IP address, MAC address, or * to indicate all receivers.

- ◆ **f*:**

Video wall identifier

Accepts a unique video wall ID or the Panel ID of a receiver within the wall.

- ◆ **STREAMS:**
Defines the signal type(s). Options include all (default), video, audio, usb, serial, ir, cec.
- ◆ **l*:**
Layout ID for video walls.
- ◆ **d*:**
Duration (in seconds) for time-based controls (e.g., OSD display).
- ◆ **a*:**
IP address of any device (for commands that apply to both Tx and Rx).

Control Keywords

Control keywords define the outcome of the command.

- ◆ **on / off:**
Enables or disables the target function.
- ◆ **reset:**
Returns the target device to factory defaults.
- ◆ **remix / default:**
Specifies EDID handling mode.
- ◆ **ro / rw / off:**
Defines access level for IPInstaller.
- ◆ **profile:**
Applies a saved system profile.

Operation Commands

This section describes the CLI commands supported by the VE8962 system. Each command includes its syntax, purpose, and examples for practical use.

sw – Switch

- ◆ Syntax:

```
sw [i<PANELID|IP|MAC>] [o<PANELID|IP|MAC|*>]
[STREAMS] [on|off]
```

- ◆ Description:

The sw command routes signals from a transmitter (Tx) to a receiver (Rx). It can handle multiple signal types, including video, audio, USB, serial, IR, and CEC. By default, all streams are switched unless specified otherwise.

- ◆ Examples:

1. Connect transmitter Tx001 to a receiver identified by MAC 00:10:74:07:00:64:

```
sw i001 o0010740700640000
```

2. Disconnect the current Rx (executed on Rx):

```
sw off
```

vw – Video Wall Switch

- ◆ Syntax:

```
vw f<VWID> [l<LAYOUTID>] [o...] [i...] [on|off]
```

- ◆ Description:

The vw command manages signal routing for video walls and applies predefined layouts. It enables you to assign transmitters to receivers grouped in a video wall configuration.

- ◆ Examples:

Apply splitter layout-3 to video wall ID f5c4682f4dfd10001 and assign Tx000:

```
sw i001 o0010740700640000
```

mute – Audio Mute

- ◆ Syntax:
`mute [o...] | [f...] [on|off]`
- ◆ Description:
The mute command enables or disables audio output on a receiver or video wall. It is useful when managing environments that require audio control independent of video routing.
- ◆ Examples:
Mute the audio of a video wall:
`mute f5c4682f4dfd10001 on`

blankscreen – Blank Screen

- ◆ Syntax:
`blankscreen [o...] | [f...] [on|off]`
- ◆ Description:
The blankscreen command turns the display output of a receiver or video wall on or off. When enabled, the screen shows a blank (black) output, useful for temporary concealment of content without disconnecting the video signal.
- ◆ Examples:
Blank the output of Rx with panel ID 003:
`blankscreen o003 on`

osd – On-Screen Display

- ◆ Syntax:
`osd [o...] [d<secs|-1>] [f...] [on|off]`
- ◆ Description:
The osd command controls the On-Screen Display (OSD) on receivers or video walls. You can specify a duration for which the OSD remains visible. A duration value of -1 keeps the OSD displayed until turned off.
- ◆ Examples:
 1. Show OSD on Rx o002 for 10 seconds
`osd o002 d10 on`
 2. Turn off OSD on a video wall:
`osd f5c4682f4dfd10001 off`

edid – Extended Display Identification Data

- ◆ Syntax:
`edid i<PANELID|*> <default|remix>`
- ◆ Description:
The `edid` command manages EDID (Extended Display Identification Data) handling for transmitters. It determines how display capabilities (such as resolution) are negotiated between devices.
 - ◆ `default`:
Uses the ATEN default EDID list for supported resolutions.
 - ◆ `remix`:
Aggregates common capabilities across connected displays. If no EDID can be read, the system automatically falls back to the ATEN default EDID.
- ◆ Examples:
Set all transmitters to remix mode:
`edid i* remix`

reboot – Reboot Device

- ◆ Syntax:
`reboot [a...] | [i...] | [o...]`
- ◆ Description:
The `reboot` command restarts a transmitter, receiver, or all devices. This action is commonly used to apply configuration changes or recover from error states.
- ◆ Examples:
 1. Reboot all devices in the system:
`reboot a*`
 2. Reboot receiver by IP:
`reboot a10.0.90.23`

baud – Set RS-232 Baud Rate

- ◆ Syntax:

```
baud [a...] | [i...] | [o...]  
<1200|2400|4800|9600|19200|38400|57600|115200>
```

- ◆ Description:

The baud command sets the RS-232 communication speed for transmitters or receivers. Supported baud rates range from 1200 to 115200 bps.

- ◆ Examples:

Set all transmitters to 9600 bps:

```
baud i* 9600
```

list – List Managed Resources

- ◆ Syntax:

```
list <rx|tx|device|videowall|profile>
```

- ◆ Description:

The list command displays information about devices or configurations currently managed by the system.

- ◆ Examples:

1. List all transmitters:

```
list tx
```

2. List all video walls:

```
list videowall
```

read – Read Device Status

- ◆ Syntax:
`read [i...] | [o...]`
- ◆ Description:
The read command retrieves live status information from a specified transmitter or receiver, even if the device is not currently managed by the system.
- ◆ Examples:
 1. Read status of all devices:
`read`
 2. Read status of Rx o002:
`read o002`

echo – Echo Events

- ◆ Syntax:
`echo [on|off]`
- ◆ Description:
The echo command controls whether switching events are displayed directly in the CLI session. This is useful for monitoring system activity in real time.
- ◆ Examples:
 1. Enable event echo:
`echo on`
 2. Disable event echo:
`echo off`

audiomap – Set Audio Source for Tx

- ◆ Syntax:
`audiomap [a...] | [i...] <analog|hdmI>`
- ◆ Description:
The audiomap command specifies which audio input (analog or HDMI) a transmitter uses as its source. This allows flexible audio routing independent of video settings.
- ◆ Examples:
Set transmitter with IP 10.0.90.19 to use HDMI audio:
`audiomap a10.0.90.19 hdmI`

reset – Factory Reset

- ◆ Syntax:
`reset [a...] | [i...] | [o...]`
- ◆ Description:
The reset command restores a transmitter or receiver to its factory default settings. This removes all applied configurations on the target device.
- ◆ Examples:
Reset a receiver by IP:
`reset a10.0.90.23`

hdcp – HDCP Control

- ◆ Syntax:
`hdcp [i...] [on|off]`
- ◆ Description:
The `hdcp` command enables or disables HDCP (High-bandwidth Digital Content Protection) on a transmitter. This setting may be required depending on the type of source device and display used in the installation.
- ◆ Examples:
 1. Enable HDCP on a transmitter:
`hdcp i001 on`
 2. Disable HDCP:
`hdcp i001 off`

fastswitch – Set Fast Switching Resolution

- ◆ Syntax:
`fastswitch [a...] | [o...]`
<off|4096x2160|3840x2160|1920x1200|1920x1080|1280x1024|1280x800|1280x720|1152x972|1024x768|720x576|720x480|640x480>
- ◆ Description:
The `fastswitch` command defines the output resolution for receivers when fast switching is enabled. For best results, configure all receivers to use the same resolution as the source device.
- ◆ Examples:
Set all receivers to 1920x1080 for fast switching:
`fastswitch o* 1920x1080`

profile – Apply Profile

- ◆ Syntax:

```
profile f<PROFILEID|PROFILENAME>
```

- ◆ Description:

The profile command applies a saved configuration profile to the system. Profiles capture signal routing, layout, and other settings, making it easier to restore or replicate a setup.

- ◆ Examples:

1. Apply profile by ID:

```
profile f123456
```

2. Apply profile by name:

```
profile fMeetingRoom
```

hdmi blacksreen – HDMI No-Source Behavior

- ◆ Syntax:

```
hdmi blacksreen 1|2|3
```

- ◆ Description:

The hdmi blacksreen command specifies what a receiver displays when no HDMI source is detected.

- ◆ 1: Show a black screen.

- ◆ 2: Show the ATEN logo.

- ◆ 3: Show "No Signal."

- ◆ Examples:

Configure all receivers to display a black screen when no source is present:

```
hdmi blacksreen 1
```

ipinstaller – IPInstaller Mode

- ◆ Syntax:
`ipinstaller ro|rw|off`
- ◆ Description:
The `ipinstaller` command sets the device's IPInstaller mode for network configuration.
 - ◆ **ro**: Read-only mode, can view device info but cannot modify.
 - ◆ **rw**: Read/write mode, allows full network configuration
 - ◆ **off**: Disables IPInstaller.
- ◆ Examples:
 1. Enable read-only mode:
`ipinstaller ro`
 2. Disable IPInstaller:
`ipinstaller off`

help – Command Help

- ◆ Syntax:
`help [command]`
- ◆ Description:
The `help` command lists available CLI commands or provides usage details for a specific command.
- ◆ Examples:
 1. List all commands:
`help`
 2. Show help for the `sw` command:
`help sw`

This Page Intentionally Left Blank

Safety Instructions

General

- ◆ This product is for indoor use only.
- ◆ Read all of these instructions. Save them for future reference.
- ◆ Follow all warnings and instructions marked on the device.
- ◆ Do not place the device on any unstable surface (cart, stand, table, etc.). If the device falls, serious damage will result.
- ◆ Do not use the device near water.
- ◆ Do not place the device near, or over, radiators or heat registers.
- ◆ The device cabinet is provided with slots and openings to allow for adequate ventilation. To ensure reliable operation, and to protect against overheating, these openings must never be blocked or covered.
- ◆ The device should never be placed on a soft surface (bed, sofa, rug, etc.) as this will block its ventilation openings. Likewise, the device should not be placed in a built in enclosure unless adequate ventilation has been provided.
- ◆ Never spill liquid of any kind on the device.
- ◆ Unplug the device from the wall outlet before cleaning. Do not use liquid or aerosol cleaners. Use a damp cloth for cleaning.
- ◆ The device should be operated from the type of power source indicated on the marking label. If you are not sure of the type of power available, consult your dealer or local power company.
- ◆ To prevent damage to your installation it is important that all devices are properly grounded.
- ◆ Do not allow anything to rest on the power cord or cables. Route the power cord and cables so that they cannot be stepped on or tripped over.
- ◆ Position system cables and power cables carefully; Be sure that nothing rests on any cables.
- ◆ Never push objects of any kind into or through cabinet slots. They may touch dangerous voltage points or short out parts resulting in a risk of fire or electrical shock.

- ◆ Do not attempt to service the device yourself. Refer all servicing to qualified service personnel.
- ◆ If the following conditions occur, unplug the device from the wall outlet and bring it to qualified service personnel for repair.
 - ◆ The power cord or plug has become damaged or frayed.
 - ◆ Liquid has been spilled into the device.
 - ◆ The device has been exposed to rain or water.
 - ◆ The device has been dropped, or the cabinet has been damaged.
 - ◆ The device exhibits a distinct change in performance, indicating a need for service.
 - ◆ The device does not operate normally when the operating instructions are followed.
- ◆ Only adjust those controls that are covered in the operating instructions. Improper adjustment of other controls may result in damage that will require extensive work by a qualified technician to repair.

Rack Mounting

- ◆ Before working on the rack, make sure that the stabilizers are secured to the rack, extended to the floor, and that the full weight of the rack rests on the floor. Install front and side stabilizers on a single rack or front stabilizers for joined multiple racks before working on the rack.
- ◆ Always load the rack from the bottom up, and load the heaviest item in the rack first.
- ◆ Make sure that the rack is level and stable before extending a device from the rack.
- ◆ Use caution when pressing the device rail release latches and sliding a device into or out of a rack; the slide rails can pinch your fingers.
- ◆ After a device is inserted into the rack, carefully extend the rail into a locking position, and then slide the device into the rack.
- ◆ Do not overload the AC supply branch circuit that provides power to the rack. The total rack load should not exceed 80 percent of the branch circuit rating.
- ◆ Make sure that all equipment used on the rack – including power strips and other electrical connectors – is properly grounded.
- ◆ Ensure that proper airflow is provided to devices in the rack.
- ◆ Ensure that the operating ambient temperature of the rack environment does not exceed the maximum ambient temperature specified for the equipment by the manufacturer.
- ◆ Do not step on or stand on any device when servicing other devices in a rack.

Technical Support

International

- ◆ For online technical support – including troubleshooting, documentation, and software updates: <http://support.aten.com>
- ◆ For telephone support, see *Telephone Support*, page v:

North America

Email Support		support@aten-usa.com
Online Technical Support	Troubleshooting Documentation Software Updates	http://www.aten-usa.com/support
Telephone Support		1-888-999-ATEN ext 4988

When you contact us, please have the following information ready beforehand:

- ◆ Product model number, serial number, and date of purchase
- ◆ Your computer configuration, including operating system, revision level, expansion cards, and software
- ◆ Any error messages displayed at the time the error occurred
- ◆ The sequence of operations that led up to the error
- ◆ Any other information you feel may be of help

Specifications

VE8962T

Function	VE8962T
Video Input	
Interfaces	1 × HDMI Type A Female (Black)
Impedance	100 Ω
Max. Distance	5m
Video	
Max. Data Rate	Average: 500–800Mbps
Compliance	HDMI (4K) HDCP2.3 & HDCP2.2 Compatible
Max. Resolutions / Distance	Up to 4K@100m (Cat 5e/6, point to point) Note: 4K supported: 4096 × 2160 / 3840 × 2160 @ 60Hz (4:4:4)
Video Compression	Optimized JPEG2000, proprietary codec
Latency	~ 1 frame
Audio	
Input	1 × HDMI Type A Female (Black) 1 × Mini Stereo Jack Female (Green)
Connectors	
Unit To Unit	1 × RJ-45 Female or 1 × SFP+ socket (SFP+ module excluded)
Power	1 × DC Jack (Black) with locking or 1 × RJ-45 (Power Over Ethernet, PoE+)
Control	
IR Channel	2 × Mini Stereo Jack Female (bi-directional, Black)

Function	VE8962T	
RS-232	Connector	1 × Terminal Block, 3 pole
	Baud Rate	19200
	Data Bits	8
	Stop Bits	1, no parity and flow control
USB Channel	1 × USB Type B Female (White)	
Pushbuttons		
Operating Mode Selection	3 × Push buttons for LCM operation	
LEDs		
Power	1 × DC in LED (Green) 1 × PoE LED (Green)	
Power Consumption	DC5V; 4.35W; 25BTU/h PoE: 5.4W; 30BTU/h Note: <ul style="list-style-type: none"> ◆ The measurement in Watts indicates the typical power consumption of the device with no external loading. ◆ The measurement in BTU/h indicates the power consumption of the device when it is fully loaded. 	
Environmental		
Operating Temperature	0–40°C	
Storage Temperature	-20–60°C	
Humidity	0–80% RH, Non-Condensing	
Physical Properties		
Housing	Metal	
Weight	0.73 kg (1.61 lb)	
Dimensions (L x W x H) with bracket	17.02 × 14.69 × 3.00 cm (6.7 × 5.78 × 1.18 in.)	

Function	VE8962T
Dimensions (L x W x H) without bracket	16.60 × 12.49 × 2.90 cm (6.54 × 4.92 × 1.14 in.)

VE8962R

Function	VE8962R
Video Input	
Interfaces	1 x HDMI Type A Female (Black)
Impedance	100 Ω
Max. Distance	5m
Video Output	
Interfaces	1 x HDMI Type A Female (Black)
Impedance	100 Ω
Max. Distance	5m
Video	
Max. Data Rate	Average: 500–800Mbps
Compliance	HDMI HDCP2.3 & HDCP2.2 Compatible
Max. Resolutions / Distance	Up to 4K@100m (Cat 5e/6, point to point) Note: 4K supported: 4096 × 2160 / 3840 × 2160 @ 60Hz (4:4:4)
Video Compression	Optimized JPEG2000, proprietary codec
Latency	~ 1 frame
Audio	
Output	1 x HDMI Type A Female (Black) 1 x Mini Stereo Jack Female (Green)
Connectors	
Unit To Unit	2 x RJ-45 Female (x 1 with POE+, x 1 with Daisy chain) or 1 x SFP+ socket (SFP+ module excluded)
Power	1 x DC Jack (Black) with locking or 1 x RJ-45 (Power Over Ethernet, PoE+)

Function	VE8962R	
Control		
IR Channel	2 × Mini Stereo Jack Female (bi-directional, Black)	
RS-232	Connector	1 × Terminal Block, 3 pole
	Baud Rate	19200
	Data Bits	8
	Stop Bits	1, no parity and flow control
USB Channel	2 × USB Type A Female (Black)	
Contact In	Connector: 1 × Terminal block, 2 pole (Contact IN + GND)	
Pushbuttons		
Operating Mode Selection	3 × Push buttons for LCM operation	
LEDs		
Power	1 × DC in LED (Green) 1 × PoE LED (Green)	
Power Consumption	DC5V; 9.1W; 68BTU/h PoE: 11.38W; 79BTU/h Note: <ul style="list-style-type: none"> ◆ The measurement in Watts indicates the typical power consumption of the device with no external loading. ◆ The measurement in BTU/h indicates the power consumption of the device when it is fully loaded. 	
Environmental		
Operating Temperature	0–40°C	
Storage Temperature	-20–60°C	
Humidity	0–80% RH, Non-Condensing	
Physical Properties		

Function	VE8962R
Housing	Metal
Weight	0.74 kg (1.63 lb)
Dimensions (L x W x H) with bracket	17.02 × 14.69 × 3.00 cm (6.7 × 5.78 × 1.18 in.)
Dimensions (L x W x H) without bracket	16.60 × 12.49 × 2.90 cm (6.54 × 4.92 × 1.14 in.)

Supported Browsers

Please see the table below for supported web browsers and the versions.

Web Browser	Supported Versions
Google Chrome	60.0.3112 or later
Mozilla Firefox	54.0.1 or later
Opera	46 or later

ATEN Warranty Policy

The warranty policy may vary by product category and region of purchase. For details, please visit ATEN's official website, select your purchase countries/ regions and then go to the Support Center, or contact your local ATEN sales representative for further assistance.

© Copyright 2025 ATEN® International Co., Ltd.
Released: 2025-09-05

ATEN and the ATEN logo are registered trademarks of ATEN International Co., Ltd. All rights reserved. All other brand names and trademarks are the registered property of their respective owners.