



Simply Better Connections

VE802

HDMI HDBaseT-Lite Extender
with PoH

Compliance Statements

FEDERAL COMMUNICATIONS COMMISSION INTERFERENCE STATEMENT

This equipment has been tested and found to comply with the limits for a Class A digital device, pursuant to Part 15 of the FCC Rules. These limits are designed to provide reasonable protection against harmful interference when the equipment is operated in a commercial environment. This equipment generates, uses, and can radiate radio frequency energy and, if not installed and used in accordance with the instruction manual, may cause harmful interference to radio communications. Operation of this equipment in a residential area is likely to cause harmful interference in which case the user will be required to correct the interference at his own expense.

The device complies with Part 15 of the FCC Rules. Operation is subject to the following two conditions: (1) this device may not cause harmful interference, and (2) this device must accept any interference received, including interference that may cause undesired operation.

FCC Caution

Any changes or modifications not expressly approved by the party responsible for compliance could void the user's authority to operate this equipment.

Warning

Operation of this equipment in a residential environment could cause radio interference.

Achtung

Der Gebrauch dieses Geräts in Wohnumgebung kann Funkstörungen verursachen.



KCC Statement

유선 제품용 / A 급 기기 (업무용 방송 통신 기기)
이 기기는 업무용 (A 급) 전자파적합기기로서 판매자 또는 사용자는 이
점을 주의하시기 바라며, 가정 외의 지역에서 사용하는 것을 목적으로
합니다.

Industry Canada Statement

This Class A digital apparatus complies with Canadian ICES-003.

CAN ICES-003 (A) / NMB-003 (A)**HDMI Trademark Statement**

The terms HDMI, HDMI High-Definition Multimedia Interface, and the HDMI Logo are trademarks or registered trademarks of HDMI Licensing Administrator, Inc.

**VCCI Statement**

この装置は、クラスA機器です。この装置を住宅環境で使用すると電波妨害を引き起こすことがあります。この場合には使用者が適切な対策を講ずるよう要求されることがあります。

VCCI - A**RoHS**

This product is RoHS compliant.

User Information

Online Registration

Be sure to register your product at our online support center:

| | |
|---------------|---|
| International | http://eservice.aten.com |
|---------------|---|

Telephone Support

For telephone support, call this number:

| | |
|---------------|---|
| International | 886-2-8692-6959 |
| China | 86-400-810-0-810 |
| Japan | 81-3-5615-5811 |
| Korea | 82-2-467-6789 |
| North America | 1-888-999-ATEN ext 4988 1-949-428-1111 |

User Notice

All information, documentation, and specifications contained in this manual are subject to change without prior notification by the manufacturer. The manufacturer makes no representations or warranties, either expressed or implied, with respect to the contents hereof and specifically disclaims any warranties as to merchantability or fitness for any particular purpose. Any of the manufacturer's software described in this manual is sold or licensed *as is*. Should the programs prove defective following their purchase, the buyer (and not the manufacturer, its distributor, or its dealer), assumes the entire cost of all necessary servicing, repair and any incidental or consequential damages resulting from any defect in the software.

The manufacturer of this system is not responsible for any radio and/or TV interference caused by unauthorized modifications to this device. It is the responsibility of the user to correct such interference.

The manufacturer is not responsible for any damage incurred in the operation of this system if the correct operational voltage setting was not selected prior to operation. PLEASE VERIFY THAT THE VOLTAGE SETTING IS CORRECT BEFORE USE.

Product Information

For information about all ATEN products and how they can help you connect without limits, visit ATEN on the Web or contact an ATEN Authorized Reseller. Visit ATEN on the Web for a list of locations and telephone numbers:

| | |
|---------------|---|
| International | http://www.aten.com |
| North America | http://www.aten-usa.com |

Package Contents

VE802 Package Contents

- 1 VE802T/R HDMI HDBaseT-Lite Extender with PoH
- 1 Power Adapter
- 1 IR Transmitter
- 1 IR Receiver*
- 2 Terminal Blocks
- 1 User Instructions

VE802T Package Contents

- 1 VE802T HDMI HDBaseT-Lite Transmitter with PoH
- 1 Power Adapter
- 1 IR Transmitter
- 1 Terminal Block
- 1 User Instructions

VE802R Package Contents

- 1 VE802R HDMI HDBaseT-Lite Receiver with PoH
- 1 IR Receiver*
- 1 Terminal Block
- 1 User Instructions
- 1 Power Adapter

Check to make sure that all the components are present and that nothing got damaged in shipping. If you encounter a problem, contact your dealer.

Read this manual thoroughly and follow the installation and operation procedures carefully to prevent any damage to the unit, and/or any of the devices connected to it.

Features may have been added to the VE802 since this manual was published. Please visit our website to download the most up-to-date version of the manual.

Note: * The included IR receiver supports full frequency IR signals from 30kHz to 60kHz. The IR receiver cable included with the package, however, only supports signals from 30kHz to 56 kHz.

Contents

| | |
|---|------|
| Compliance Statements | ii |
| User Information | iv |
| Online Registration | iv |
| Telephone Support | iv |
| User Notice | iv |
| Product Information | v |
| Package Contents | v |
| VE802 Package Contents | v |
| VE802T Package Contents | v |
| VE802R Package Contents | v |
| About this Manual | viii |
| Conventions | ix |
| | |
| 1. Introduction | |
| Overview | 1 |
| Features | 2 |
| Requirements | 3 |
| Display | 3 |
| Source Device | 3 |
| Cables | 3 |
| Components | 4 |
| | |
| 2. Hardware Setup | |
| Setting Up | 9 |
| Installation Diagram | 10 |
| RS-232 Channel Transmission | 10 |
| | |
| 3. Operation | |
| LED Display | 13 |
| VE802T (Transmitter) and VE802R (Receiver) 13 | |
| | |
| Appendix 15 | |
| Safety Instructions | 15 |
| General | 15 |
| Technical Support | 17 |
| International | 17 |
| North America | 17 |
| Specifications | 18 |
| Limited Warranty | 19 |

About this Manual

This User Manual is provided to help you get the most from your system. It covers all aspects of installation, configuration and operation. An overview of the information found in the manual is provided below.

Chapter 1, Introduction, introduces you to the VE802 system. Its purpose, features and benefits are presented, and its front and back panel components are described.

Chapter 2, Hardware Setup, describes the steps that are necessary to quickly and safely set up your installation.

Chapter 3, Operation, explains the fundamental concepts involved in operating the VE802

An Appendix, provides specifications and other technical information regarding the VE802.

Note:

- ◆ Read this manual thoroughly and follow the installation and operation procedures carefully to prevent any damage to the unit and/or connected devices.
 - ◆ The product may be updated, with features and functions added, improved, or removed since the release of this manual. For an up-to-date user manual, visit <http://www.aten.com/global/en/>.
-

Conventions

This manual uses the following conventions:

- Monospaced Indicates text that you should key in.
- [] Indicates keys you should press. For example, [Enter] means to press the **Enter** key. If keys need to be chorded, they appear together in the same bracket with a plus sign between them: [Ctrl+Alt].
1. Numbered lists represent procedures with sequential steps.
- ◆ Bullet lists provide information, but do not involve sequential steps.
- > Indicates selecting the option (on a menu or dialog box, for example), that comes next. For example, Start > Run means to open the *Start* menu, and then select *Run*.
-  Indicates critical information.

This Page Intentionally Left Blank

Chapter 1

Introduction

Overview

The VE802 HDMI HDBaseT-Lite Extender extends an HDBaseT signal up to 70m from the HDBaseT source using one Cat 5e/6 cable. VE802 supports RS-232 and IR signaling pass-through, allowing you to control the HDMI source device from the remote unit (VE802R) while also granting access to the HDMI display device from the local unit (VE802T). IR signals can also be extended in both directions. The VE802 features Power over HDBaseT (PoH) which can send power over Cat 5e/6 cable without an additional power supply. The VE802 is HDMI (3D, Deep Color, 4kx2k) and HDCP compatible. The VE802 is perfect for a digital entertainment center or any installation that requires superior video quality.

Features

- ◆ HDBaseT Connectivity – extends an HDMI connection over a long distance via one Cat 5e/6a cable
- ◆ HDBaseT Anti-jamming – resists signal interference during high-quality video transmission using HDBaseT technology
- ◆ EDID Expert – configures optimum EDID settings for smooth power-up, high-quality display and use of the best resolution across different screens
- ◆ PoH (Power over HDBaseT) – supplies power from Transmitter to Receiver over a long distance via one Cat 5e/6a cable
- ◆ A bi-directional RS-232 serial port to connect with a high-end system for more device control
- ◆ A bi-directional IR channel for IR signal control; IR transmission is processed one way at a time
- ◆ Supports IR signal frequencies from 30kHz to 60kHz*
- ◆ Rack- Mountable

Note: * The included IR receiver supports full frequency IR signals from 30kHz to 60kHz. The IR receiver cable included with the package, however, only supports signals from 30kHz to 56 kHz.

Requirements

Display

- ♦ An HDMI display capable of the highest required resolution

Source Device

The following equipment is required:

- ♦ A source device with an HDMI port

Cables

- ♦ Cat 5e cable is required to connect the Transmitter and Receiver units. Cable of a lower standard will result in degrading the video signal. We strongly recommend using Cat 5e cables or above.
- ♦ For better quality over longer distances, we suggest using 2L – 2801 (350 MHz) Low Skew Cable.

Maximum Cable Distances

| Connection | Distance |
|--|----------|
| Computer to Transmitter (VE802T) | 3 m |
| Transmitter (VE802T) to Receiver (VE802R) | 70 m* |
| Receiver (VE802R) to monitor | 3 m |

Note:* 70m is the maximum cable distance when using a Cat 6a or above cable.

Components

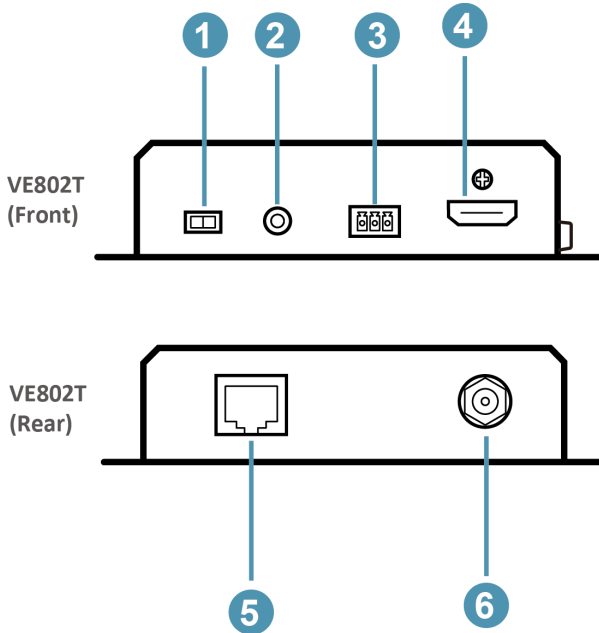

| No. | Component | Description |
|-----|---------------------|--|
| 1 | F/W Upgrade Switch | The Firmware upgrade port is reserved for tech support. If you would like to do a firmware upgrade yourself, please contact your dealer. |
| 2 | IR Port | Connect an IR Transmitter to the IR port on the VE802T. |
| 3 | RS-232 Port | You can connect the RS-232 main controller to the VE802, such as the PC or Control system. |
| 4 | HDMI Input Port | Connect the HDMI Input Port on the VE802T to the HDMI Output Port on the video source device using an HDMI cable. |
| 5 | HDBaseT Output Port | The Cat 5e cables that connects the Receiver Units, plug in here. |
| 6 | Locking Power Jack | The cable from the Power adapter connects here. |

See Chapter 3, Operation for details.

VE802T Top View

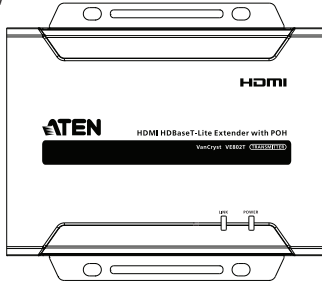

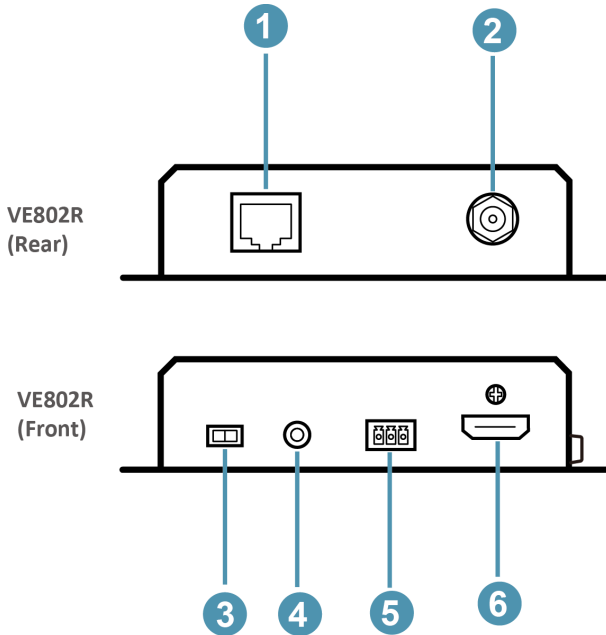

| No. | Component | Description |
|-----|--------------------|--|
| 1 | HDBaseT Input Port | The Cat 5e cables that connects to the Transmitter Unit plugs in here. |
| 2 | Locking Power Jack | The cable from the Power adapter connects here. |
| 3 | F/W Upgrade Switch | The Firmware upgrade port is reserved for tech support. If you would like to do a firmware upgrade yourself, please contact your dealer. |
| 4 | IR Port | Connect an IR Receiver to the IR port on the VE802R. |
| 5 | RS-232 Port | You can connect RS-232 serial devices/ peripherals to the VE802, such as touchscreens and bar code scanners. |
| 6 | HDMI Output Port | Connect the HDMI display to this port. |

VE802R Top View

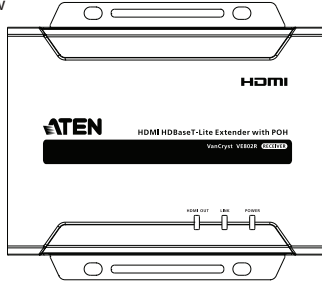

See Chapter 3, Operation for details.

This Page Intentionally Left Blank

Chapter 2

Hardware Setup



1. Important safety information is provided on page 15. Please review it before proceeding.
2. Make sure that the power to all devices connected to the installation are turned off. You must unplug the power cords of any computers that have the Keyboard Power On function.

Setting Up

Setting up the VE802 HDBaseT-Lite Extender system is simply a matter of plugging in the cables. Make sure that all the equipment to be connected are powered off, then refer to the installation diagram on the next page and do the following:

1. Connect the HDMI Input Port on the VE802T to the HDMI Output Port on your video source device using HDMI cable.
2. Connect one end of the RJ-45 cable to the HDBaseT output port on the transmitter. Then connect the other end of the RJ-45 cable to the HDBaseT input port on the receiver.
3. Connect the HDMI Output Port on the VE802R to the HDMI Input Port on your video display device using HDMI Cable.
4. Plug the power adapter into the power jack on the VE802T.
(Optional) Plug the power adapter into the Power Jack on the VE802R if necessary.
5. (Optional) Connect you computer or controller system to the terminal block on the VE802 to serial commands
6. (Optional) Connect an IR Transmitter/Receiver to the IR port on the VE802T/VE802R.

Installation Diagram

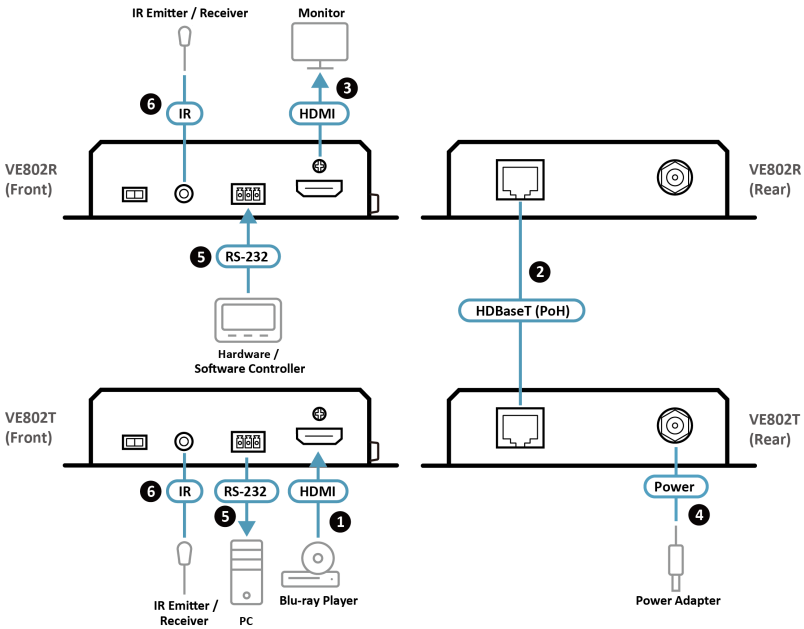

RS-232 Channel Transmission

You can connect RS-232 serial devices/peripherals to the VE802, such as touchscreens and bar code scanners. The RS-232 signal transmission flow is shown in the following example:

From a source device, the RS-232 signal is transmitted (Tx) to the VE802T receiving (Rx) unit; the VE802R transmits (Tx) signals to the display device (Rx).

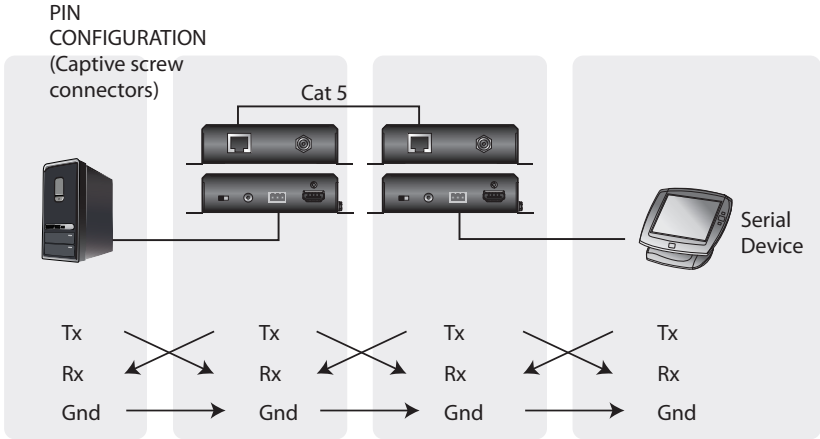

This Page Intentionally Left Blank

Chapter 3

Operation

LED Display

The VE802 Transmitter and Receiver units have front panel LEDs to indicate their operating status, as shown in the tables, following:

VE802T (Transmitter) and VE802R (Receiver)

| LED | Indication |
|---------------|---|
| Power (Green) | Lights to indicate that the system is receiving power. |
| Link (Orange) | <ul style="list-style-type: none">◆ Light is static to indicate that the connection to the Transmitter and Receiver units are ok.◆ Flashes when there is a problem with the connection. |
| HDMI Out* | <ul style="list-style-type: none">◆ Light is static HDMI display is normal with HDCP key.◆ Flashes when HDMI display is normal without HDCP key.◆ OFF when there is no HDMI Signal. |

Note: *HDMI Out LED VE802R only.

This Page Intentionally Left Blank

Appendix

Safety Instructions

General

- ◆ Read all of these instructions. Save them for future reference.
- ◆ Follow all warnings and instructions marked on the device.
- ◆ This product is for indoor use only.
- ◆ Do not place the device on any unstable surface (cart, stand, table, etc.). If the device falls, serious damage will result.
- ◆ Do not use the device near water.
- ◆ Do not place the device near, or over, radiators or heat registers.
- ◆ The device cabinet is provided with slots and openings to allow for adequate ventilation. To ensure reliable operation, and to protect against overheating, these openings must never be blocked or covered.
- ◆ The device should never be placed on a soft surface (bed, sofa, rug, etc.) as this will block its ventilation openings. Likewise, the device should not be placed in a built in enclosure unless adequate ventilation has been provided.
- ◆ Never spill liquid of any kind on the device.
- ◆ Unplug the device from the wall outlet before cleaning. Do not use liquid or aerosol cleaners. Use a damp cloth for cleaning.
- ◆ The device should be operated from the type of power source indicated on the marking label. If you are not sure of the type of power available, consult your dealer or local power company.
- ◆ To prevent damage to your installation, it is important that all devices are properly grounded.
- ◆ Do not allow anything to rest on the power cord or cables. Route the power cord and cables so that they cannot be stepped on or tripped over.
- ◆ Position system cables and power cables carefully; Be sure that nothing rests on any cables.
- ◆ Never push objects of any kind into or through cabinet slots. They may touch dangerous voltage points or short out parts resulting in a risk of fire or electrical shock.
- ◆ Do not attempt to service the device yourself. Refer all servicing to qualified service personnel.

- ◆ If the following conditions occur, unplug the device from the wall outlet and bring it to qualified service personnel for repair.
 - ◆ The power cord or plug has become damaged or frayed.
 - ◆ Liquid has been spilled into the device.
 - ◆ The device has been exposed to rain or water.
 - ◆ The device has been dropped, or the cabinet has been damaged.
 - ◆ The device exhibits a distinct change in performance, indicating a need for service.
 - ◆ The device does not operate normally when the operating instructions are followed.
- ◆ Only adjust those controls that are covered in the operating instructions. Improper adjustment of other controls may result in damage that will require extensive work by a qualified technician to repair.
- ◆ This product is for indoor use only.

Technical Support

International

- ◆ For online technical support – including troubleshooting, documentation, and software updates: <http://eservice.aten.com>
- ◆ For telephone support, *Telephone Support*, page iv

North America

| | | |
|--------------------------|--|---|
| Email Support | | support@aten-usa.com |
| Online Technical Support | Troubleshooting Documentation Software Updates | http://www.aten-usa.com/support |
| Telephone Support | | 1-888-999-ATEN ext 4988 |

When you contact us, please have the following information ready beforehand:

- ◆ Product model number, serial number, and date of purchase.
- ◆ Your computer configuration, including operating system, revision level, expansion cards, and software.
- ◆ Any error messages displayed at the time the error occurred.
- ◆ The sequence of operations that led up to the error.
- ◆ Any other information you feel may be of help.

Specifications

| Function | | VE802R | VE802T |
|---------------------|------------------------------|---|--|
| Video Input | Interface | N/A | 1 x HDMI Type A Female (Black) |
| | Impedance | N/A | 100Ω |
| | Max distance | N/A | 3m |
| Video Output | Interface | 1 x HDMI Type A Female (Black) | N/A |
| | Impedance | 100Ω | N/A |
| | Max distance | 3m | N/A |
| Video | Max. data rate | 10.2Gbps (3.4Gbps per lane) | |
| | Max. pixel clock | 340 MHz | |
| | Compliance | HDMI (3D, Deep Color, 4K) HDCP2.2 Compatible Consumer Electronics Control (CEC) | |
| | Max resolutions/ Distance | Up to 4K @ 35 m (Cat 5e/6) / 40 m (Cat 6a / ATEN 2L-2910 Cat 6); 1080p @ 60 m (Cat 5e/6) / 70 m (Cat 6a / ATEN 2L-2910 Cat 6) *4K supported: 4096 x 2160 / 3840 x 2160 @ 60 Hz (4:2:0); 4096 x 2160 / 3840 x 2160 @ 30 Hz (4:4:4) | |
| Audio | Input | N/A | 1 x HDMI Type A Female (Black) |
| | Output | 1 x HDMI Type A Female (Black) | N/A |
| Control | RS-232 | Connector | 1x Terminal Block,3 pole |
| | | Baud rate and protocol | Baud Rate: 19200, Data Bits:8, Stop Bits:1, no parity and flow control |
| | IR | 1 x Mini Stereo Jack Female (Black) | |
| Power | Connector | 1 x DC Jack (Black) with locking or 1 x RJ-45 (Power over HDBaseT, PoH) | 1 x DC Jack (Black) with locking |
| | Consumption | DC5V:4.37W:20BTU PoH:5.46W:25BTU | DC5V:2.7W:13BTU |
| Environment | Operating temp. | 0-50°C | |
| | Storage temp. | -20-60°C | |
| | Humidity | 0-80% RH, Non-condensing | |
| Physical Properties | Housing | Metal | |
| | Weight | 0.46 kg (1.01 lb) | 0.44 kg (0.97 lb) |
| | Dimensions (LxWxH) | 13.60 x 10.10 x 2.90 cm | 13.60 x 10.10 x 2.90 cm |

Limited Warranty

ATEN warrants its hardware in the country of purchase against flaws in materials and workmanship for a Warranty Period of two [2] years (warranty period may vary in certain regions/countries) commencing on the date of original purchase. This warranty period includes the [LCD panel of ATEN LCD KVM switches](#). Select products are warranted for an additional year (see [A+ Warranty](#) for further details). Cables and accessories are not covered by the Standard Warranty.

What is covered by the Limited Hardware Warranty

ATEN will provide a repair service, without charge, during the Warranty Period. If a product is defective, ATEN will, at its discretion, have the option to (1) repair said product with new or repaired components, or (2) replace the entire product with an identical product or with a similar product which fulfills the same function as the defective product. Replaced products assume the warranty of the original product for the remaining period or a period of 90 days, whichever is longer. When the products or components are replaced, the replacing articles shall become customer property and the replaced articles shall become the property of ATEN.

To learn more about our warranty policies, please visit our website:
<http://www.aten.com/global/en/legal/policies/warranty-policy/>

© Copyright 2023 ATEN® International Co., Ltd.
Released: 2023-01-16

ATEN and the ATEN logo are registered trademarks of ATEN International Co., Ltd. All rights reserved.
All other brand names and trademarks are the registered property of their respective owners.