



Simply Better Connections

KH1508Ai / KH1516Ai

Cat 5 High-Density KVM Over the NET™
User Manual

Compliance Statements

FEDERAL COMMUNICATIONS COMMISSION INTERFERENCE STATEMENT

This equipment has been tested and found to comply with the limits for a Class A digital device, pursuant to Part 15 of the FCC Rules. These limits are designed to provide reasonable protection against harmful interference when the equipment is operated in a commercial environment. This equipment generates, uses, and can radiate radio frequency energy and, if not installed and used in accordance with the instruction manual, may cause harmful interference to radio communications. Operation of this equipment in a residential area is likely to cause harmful interference in which case the user will be required to correct the interference at his own expense.

The device complies with Part 15 of the FCC Rules. Operation is subject to the following two conditions: (1) this device may not cause harmful interference, and (2) this device must accept any interference received, including interference that may cause undesired operation.

FCC Caution

Any changes or modifications not expressly approved by the party responsible for compliance could void the user's authority to operate this equipment.

Warning

Operation of this equipment in a residential environment could cause radio interference.

Achtung

Der Gebrauch dieses Geräts in Wohnumgebung kann Funkstörungen verursachen.

Suggestion

Shielded twisted pair (STP) cables must be used with the unit to ensure compliance with FCC & CE standards.



KCC Statement

유선 제품용 / A 급 기기 (업무용 방송 통신 기기)
이 기기는 업무용 (A 급) 전자파적합기기로서 판매자 또는 사용자는 이
점을 주의하시기 바라며, 가정 외의 지역에서 사용하는 것을 목적으로
합니다.

Industry Canada Statement

This Class A digital apparatus complies with Canadian ICES-003.

CAN ICES-003 (A) / NMB-003 (A)

RoHS

This product is RoHS compliant.

遠端 KVM 多電腦切換器類產品

設備名稱 Equipment Name	1 位本地 / 遠端使用者分享存取 8/16 埠多介面 Cat 5 KVM over IP 切換器遠端電腦管理分案			型號 (型式) Type designa- tion (Type)	KH1508Ai / KH1516Ai	
單元 Unit	限用物質及其化學符號 Restricted substances and its chemical symbols					
	鉛 Lead (Pb)	汞 Mercury (Hg)	鎘 Cadmium (Cd)	六價鉻 Hexavalent chromium (Cr ⁺⁶)	多溴聯苯 Polybrominated biphenyls (PBB)	多溴二苯醚 Polybrominated diphenyl ethers (PBDE)
電纜線 Cable	-	○	○	○	○	○
印刷電路部件 PCBA	-	○	○	○	○	○
塑膠 / 其他部件 Plastic / Other parts	○	○	○	○	○	○
金屬部件 Metal parts	-	○	○	○	○	○

備考 1. “超出 0.1 wt %” 及 “超出 0.01 wt %” 係指限用物質之百分比含量超出百分比含量基準值。
Note 1: “Exceeding 0.1 wt %” and “exceeding 0.01 wt %” indicate that the percentage content of the restricted substance exceeds the reference percentage value of presence condition.

備考 2. “○” 係指該項限用物質之百分比含量未超出百分比含量基準值。

Note 2: “○” indicates that the percentage content of the restricted substance does not exceed the percentage of reference value of presence.

備考 3. “-” 係指該項限用物質為排除項目。

Note 3: “-” indicates that the restricted substance corresponds to the exemption.

製造商：宏正自動科技股份有限公司

地址：新北市汐止區大同路二段 125 號三樓

警告：為避免電磁干擾，本產品不應安裝或使用於住宅環境。

User Information

Online Registration

Be sure to register your product at our online support center:

International	http://eservice.aten.com
---------------	---

Telephone Support

For telephone support, call this number:

International	886-2-8692-6959
China	86-400-810-0-810
Japan	81-3-5615-5811
Korea	82-2-467-6789
North America	1-888-999-ATEN ext 4988 1-949-428-1111

User Notice

All information, documentation, and specifications contained in this manual are subject to change without prior notification by the manufacturer. The manufacturer makes no representations or warranties, either expressed or implied, with respect to the contents hereof and specifically disclaims any warranties as to merchantability or fitness for any particular purpose. Any of the manufacturer's software described in this manual is sold or licensed *as is*. Should the programs prove defective following their purchase, the buyer (and not the manufacturer, its distributor, or its dealer), assumes the entire cost of all necessary servicing, repair and any incidental or consequential damages resulting from any defect in the software.

The manufacturer of this system is not responsible for any radio and/or TV interference caused by unauthorized modifications to this device. It is the responsibility of the user to correct such interference.

The manufacturer is not responsible for any damage incurred in the operation of this system if the correct operational voltage setting was not selected prior to operation. PLEASE VERIFY THAT THE VOLTAGE SETTING IS CORRECT BEFORE USE.

Product Information

For information about all ATEN products and how they can help you connect without limits, visit ATEN on the Web or contact an ATEN Authorized Reseller. Visit ATEN on the Web for a list of locations and telephone numbers:

International	http://www.aten.com
North America	http://www.aten.com/us/en/

Package Contents

Check to make sure that all the components are in working order. If you encounter any problem, please contact your dealer.

The KH1508Ai / KH1516Ai package consists of:

- 1 KH1508Ai or KH1516Ai Cat 5 High-Density KVM Over the NET™ Switch
- 1 firmware upgrade cable
- 1 Laptop USB cable
- 1 power cord
- 1 mounting kit
- 1 foot pad set (4 pcs)
- 1 user instructions

Contents

Compliance Statements	ii
User Information	v
Online Registration	v
Telephone Support	v
User Notice	v
Product Information	vi
Package Contents	vii
Contents	viii
About This Manual	xiv
Conventions	xv

Chapter 1.

Introduction

Overview	1
Features	3
Hardware	3
Management	3
Ease-to-Use Interface	3
Advanced Security	4
Virtual Remote Desktop	4
Requirements	5
General	5
Console	5
Computers	5
KVM Adapter Cables	6
Adapter Cable Resolutions	6
Operating Systems	7
Components	8
Front View	8
Rear View	10

Chapter 2.

Hardware Setup

Overview	13
Before You Begin	13
Stacking and Rack Mounting	14
Stacking	14
Rack Mounting	15
Single Station Installation	16
Single Stage Installation Diagram	17
KVM Adapter Cable Installation Diagrams	18
KVM Adapter Cable Installation Diagrams cont.	19
Daisy Chaining	20
Daisy Chain Installation Diagram	21

Chapter 3.**Basic Operation**

Port Selection	23
Manual	23
OSD / GUI	23
Keyboard Hotkeys	23
Hot Plugging	24
Hot Plugging Stations	24
Hot Plugging KVM Ports	24
Hot Plugging Console Ports	24
The Adapter ID Function	25
Powering Off and Restarting	26
Port ID Numbering	26

Chapter 4.**OSD Operation**

OSD Overview	27
OSD Navigation	29
OSD Main Screen Headings	29
OSD Functions	30
F1: GOTO	30
F2: LIST	31
F3: SET	32
F4: ADM	35
F5: SKP	38
F6: BRC	39
F7: SCAN	40
F8: LOUT	41
Hotkey Port Control	41
Invoking Hotkey Mode	42
Selecting the Active Port	43
Auto Scan Mode Switching	44
Skip Mode Switching	46
Computer Keyboard / Mouse Reset	47
Setting the Hotkey Beeper ON/OFF	47
Setting the Hotkey key combination	48
Setting the OSD Hotkey combination	48
Setting the Port Operating System	49
Restore the Default Values	49
Hotkey Summary Table	50

Chapter 5.**Logging In**

Overview	51
Laptop USB Console Login	52
Browser Login	53

Windows Client AP Login	54
The Windows Client AP Connection Screen	55
Connecting – Windows Client AP	56
Java Client AP Login	57
The Java Client AP Connection Screen	58
Connecting – Java Client AP	59

Chapter 6.

The User Interface

Overview	61
The Web Browser Main Page	61
Page Components	62
The Tab Bar	63
Laptop USB Console Main Page	64
The AP GUI Main Page	65
The Control Panel	66
WinClient Control Panel	66
WinClient Control Panel Functions	68
Macros	70
Video Settings	79
The Message Board	82
Zoom	84
The On-Screen Keyboard	85
Mouse Pointer Type	87
Mouse DynaSync Mode	88
Control Panel Configuration	90
The Java Control Panel	92

Chapter 7.

Port Access

Overview	93
Browser GUI	93
AP GUI	93
The Sidebar	95
The Sidebar Tree Structure	95
View Filter	96
Connections	97
Device Level	97
Port Level	98
User Preferences	99
Sessions	101
Access Rights	102
Browser GUI Interface	102
AP GUI Interface	103
Saving Changes	103

Chapter 8.

User Management

Overview	105
Browser GUI	105
AP GUI	105
Users	106
Adding Users	106
Modifying User Accounts	108
Deleting User Accounts	109
Device Assignment	110
Assigning Device Permissions From the User's Notebook	110

Chapter 9.

Device Management

KVM Devices	113
Device Information	113
Network	115
ANMS	119
Security	124
Port Configuration	131
Date/Time	132

Chapter 10.

Log

Overview	135
Browser GUI	135
AP GUI	135
Log Information	136

Chapter 11.

Maintenance

Overview	137
Browser GUI	137
AP GUI	137
Device IP Card Firmware Upgrade	138
Mainboard and KVM Adapter Cable Firmware Upgrade	139
Mainboard Firmware Upgrade	139
KVM Adapter Cable Firmware Upgrade	140
Firmware Upgrade Recovery	142
Device IP Card Firmware	142
Mainboard and KVM Adapter Cable Firmware	142
Backup/Restore	143
Backup	143
System Operation	144
Clear Port Names:	144
Reset to Default:	144
System Reset:	144

Chapter 12.**Download**

Overview	145
--------------------	-----

Chapter 13.**Port Operation**

Overview	147
Connecting to a Port	148
The Port Toolbar	149
The Toolbar Icons	150
Toolbar Hotkey Port Switching	151
Recalling the Port Access Page	153
GUI Hotkey Summary Table	153
Panel Array Mode	154
Panel Array Toolbar	155
Multiuser Operation	156

Chapter 14.**The Log Server**

Installation	157
Starting Up	158
The Menu Bar	159
Configure	159
Events	160
Options	162
Help	162
The Log Server Main Screen	163
Overview	163
The List Panel	164
The Event Panel	164

Appendix

Safety Instructions	165
General	165
Rack Mounting	167
Consignes de sécurité	168
Général	168
Montage sur bâti	171
Technical Support	172
International	172
North America	172
Troubleshooting	173
Administration	173
General Operation	173
The Windows Client	174
The Java Client	174

The Log Server	175
Panel Array Mode	175
Sun Systems	176
Additional Mouse Synchronization Procedures	177
IP Address Determination	179
The Local Console	179
IP Installer	179
Browser	180
Specifications	181
Trusted Certificates	183
Overview	183
Installing the Certificate	184
Certificate Trusted	185
Self-Signed Private Certificates	186
Examples	186
Importing the Files	186
Connection Tables	187
KH1508Ai	187
KH1516Ai	187
Supported Devices	188
OSD Factory Default Settings	188
Administrator Login Failure	189
ATEN Standard Warranty Policy	190

About This Manual

This User Manual is provided to help you get the most from your KH1508Ai / KH1516Ai system. An overview of the information found in the manual is provided below.

Chapter 1, *Introduction*, introduces you to the KH1508Ai / KH1516Ai system. Its purpose, features and benefits are presented, and its front and back panel components are described.

Chapter 2, *Hardware Setup*, describes how to set up your installation. The necessary steps – from a basic single stage hookup to a complete 16 switch daisy chained operation are provided.

Chapter 3, *Basic Operation*, explains the fundamental concepts involved in operating the KH1508Ai / KH1516Ai.

Chapter 4, *OSD Operation*, describes the concepts and procedures used to operate the KH1508Ai / KH1516Ai via its text-based on-screen display (OSD) from a locally connected KVM console.

Chapter 5, *Logging In*, describes how to log into the KH1508Ai / KH1516Ai via its Graphical User Interface (GUI) with each of the available access methods: from a local Laptop console; an internet browser; a standalone Windows application (AP) program; and a standalone Java application (AP) program.

Chapter 6, *The User Interface*, describes the layout and explains the components of the KH1508Ai / KH1516Ai's user interface.

Chapter 7, *Port Access*, describes the Port Access page and how to use it to configure the options it provides regarding port manipulation.

Chapter 8, *User Management*, shows administrators how to create, modify, and delete users, and assign attributes to them.

Chapter 9, *Device Management*, shows administrators how to configure and control overall KH1508Ai / KH1516Ai operations.

Chapter 10, *Log*, shows how to use the log file utility to view all the events that take place on the KH1508Ai / KH1516Ai.

Chapter 11, *Maintenance*, explains how to upgrade the KH1508Ai / KH1516Ai's firmware, as well as the firmware of the KVM Adapter Cables used to connect its ports to the installed devices.

Chapter 12, *Download*, describes how to download standalone AP versions of the Win Client, the Java Client, the Log Server, and Power Over the Net (PoN) programs.

Chapter 13, *Port Operation*, provides detailed information on accessing and operating the devices connected to the KH1508Ai / KH1516Ai's ports.

Chapter 14, *The Log Server*, explains how to install and configure the Log Server.

Appendix, provides specifications and other technical information regarding the KH1508Ai / KH1516Ai.

Note:

- ◆ Read this manual thoroughly and follow the installation and operation procedures carefully to prevent any damage to the unit or connected devices.
 - ◆ The product may be updated, with features and functions added, improved or removed since the release of this manual. For an up-to-date user manual, visit <http://www.aten.com/global/en/>
-

Conventions

This manual uses the following conventions:

Monospaced	Indicates text that you should key in.
[]	Indicates keys you should press. For example, [Enter] means to press the Enter key. If keys need to be chorded, they appear together in the same bracket with a plus sign between them: [Ctrl+Alt].
1.	Numbered lists represent procedures with sequential steps.
◆	Bullet lists provide information, but do not involve sequential steps.
>	Indicates selecting the option (on a menu or dialog box, for example), that comes next. For example, Start > Run means to open the <i>Start</i> menu, and then select <i>Run</i> .
	Indicates critical information.

This Page Intentionally Left Blank

Chapter 1

Introduction

Overview

The KH1508Ai / KH1516Ai KVM Over the NET™ switches are control units that allow access to multiple computers from a single KVM (keyboard, monitor, and mouse) console.

A single KH1508Ai / KH1516Ai can control up to 8 / 16 computers. As many as 15 additional KVM switches can be daisy chained from the original unit, so that up to 256 computers can all be controlled from the original KVM console.

Note: See *Supported Devices*, page 188, for a list of KVM switches that can be installed on a KH1508Ai / KH1516Ai daisy chain.

Since the KH1508Ai / KH1516Ai uses TCP/IP for its communications protocol, it can be accessed from any computer on the Net – whether that computer is located down the hall, down the street, or half-way around the world.

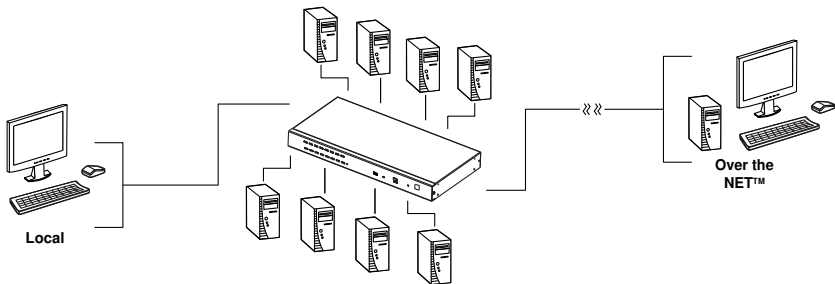

In addition to TCP/IP connectivity, the KH1508Ai / KH1516Ai provides local ports for a locally attached USB or PS/2 console and a Laptop console – allowing access and control from the data center as well as over the Net. The switches utilize a single shared bus implementation – although they support local and remote login at the same time, they do not support independent operation. If a local user logs in while a remote user has already opened a session, the local user sees the same screen that the remote user is working on.

For local access, the KH1508Ai / KH1516Ai supports resolutions of 1600x1200@60Hz for an extended distance of up to 40 m, as well as 1280x1024@75Hz for an extended distance of 50 m. For remote access, the switches support up to 1280x1024@75Hz.

The switches feature RJ-45 connectors and Cat 5e/6 cable to link to the computers. Utilizing PS/2, USB, and serial KVM Adapter Cables for the final linkup, the KH1508Ai / KH1516Ai permits any combination of PCs, Macs, Sun computers, and serial devices to coexist on the installation. Use of the adapter cables dramatically reduces cable clutter, and makes reconfiguring the installation easy and convenient.

A custom ASIC (patent pending) provides an auto-sensing function that recognizes the position of each station on the chain, eliminating the need to manually set the position with DIP switches. A seven segment front panel LED displays each Station's position for easy identification.

The KH1508Ai / KH1516Ai has been designed to work seamlessly with the ALTUSEN CC2000 Control Center Over the NET™ for ease of access and administration. It also allows the IP address configuration to be easily configured from the local console OSD.

Your KH1508Ai / KH1516Ai investment is protected by a firmware upgrade utility. You can stay current with the latest improvements in functionality by downloading firmware update files from our website, and using the utility to quickly and conveniently install them.

Setting up the KH1508Ai / KH1516Ai is fast and easy; plugging cables into their appropriate ports is all that is entailed. Because the KH1508Ai / KH1516Ai intercepts keyboard and mouse input directly, there is no software to configure; no need to get involved in complex installation routines; no need to be concerned with incompatibility problems.

Access to any computer on the installation is easily accomplished--either by pressing front panel port selection switches; entering hotkey combinations from the keyboard; or by means of a powerful menu driven OSD (On Screen Display) system. A convenient Auto Scan function also permits automatic scanning and one-by-one monitoring of the activities of selected computers.

There is no better way to save time and money than with a KH1508Ai / KH1516Ai installation. By allowing a single console to manage up to 256 computers, a KH1508Ai / KH1516Ai installation: (1) eliminates the expense of having to purchase a separate keyboard, monitor, and mouse for each; (2) saves all the space those extra components would take up; (3) saves on energy costs; and (4) eliminates the inconvenience and wasted effort involved in constantly moving from one computer to another.

Features

Hardware

- ◆ Dedicated USB port directly connects to a laptop for easy console operation
- ◆ High port density – RJ-45 connectors for up to 16 ports in a 1U housing
- ◆ One bus for remote KVM over IP access
- ◆ Supports PS/2, USB, Sun Legacy (13W3) and serial (RS-232) connectivity
- ◆ Local console provides PS/2 and USB keyboard and mouse support
- ◆ Supports multiplatform server environments: Windows, Mac, Sun, Linux and serial devices
- ◆ High video resolution – up to 1600 x 1200 @ 60Hz at up to 40 meters and 1280 x 1024 @ 75Hz at up to 50 meters, with the new ATEN KVM Cable Adapter KA7000 series.
- ◆ Daisy chain up to 15 additional units – control up to 128 (KH1508Ai) or 256 (KH1516Ai) computers from a single console.

Management

- ◆ Up to 64 user accounts – up to 32 users simultaneously share the control
- ◆ End session feature – administrators can terminate running sessions
- ◆ Event logging and Windows-based Log Server support
- ◆ Local Log Event
- ◆ Firmware upgradeable
- ◆ Adapter ID – stores port information allowing administrators to relocate the servers to different ports, without having to reconfigure the adapters and switch
- ◆ Port Share Mode allows multiple users to gain access to a server simultaneously
- ◆ Integration with ALTUSEN CC2000 Management software

Ease-to-Use Interface

- ◆ Local Console, Browser, and AP GUIs offer a unified multilanguage interface to minimize user training time and increase productivity
- ◆ Multiplatform client support (Windows, Mac OS X, Linux, Sun)

- ◆ Multibrowser support (IE, Firefox, Safari, Opera, Netscape)
- ◆ Browser-based UI in pure Web technology allows administrators to perform administrative tasks without the need for Java to be pre-installed
- ◆ User can launch multiple Virtual Remote Desktops to control multiple connected servers from the same login session
- ◆ Full-screen or sizable and scalable Virtual Remote Desktop
- ◆ Panel Array Mode
- ◆ Device ID and attributes are stored in the adapter cables allowing you to hot-swap port connections without having to reconfigure attributes.
- ◆ Local keyboard broadcast – keyboard input can be duplicated on all the attached servers.

Advanced Security

- ◆ Remote authentication support: RADIUS, LDAP, LDAPS, and MS Active Directory
- ◆ Advanced security features include password protection and advanced encryption technologies – 1024 bit RSA; 56 bit DES; 256 bit AES; and TLS 1.2
- ◆ Flexible encryption design allows users to choose any combination of 56-bit DES, 168-bit 3DES 256-bit AES, 128-bit RC4, or Random for independent KB/Mouse, video, and virtual media data encryption
- ◆ Support for IP/MAC Filter
- ◆ Configurable user and group permissions for server access and control

Virtual Remote Desktop

- ◆ Video quality and video tolerance can be adjusted to optimize data transfer speed; monochrome color depth setting, threshold and noise settings for compression of the data bandwidth in low bandwidth situations
- ◆ Full screen or scalable video display
- ◆ Message Board for communication among remote users
- ◆ Mouse DynaSync™ – automatically synchronizes the local and remote mouse movements
- ◆ On-screen keyboard with multilanguage support
- ◆ BIOS-level access

Requirements

General

- ◆ We recommend computers with at least a P 4 2 GHz processor, with 1G of memory, with their screen resolution set to 1024 x 768.
- ◆ Browsers must support TLS 1.2 encryption.
- ◆ For the *Log Server*, you must have the Microsoft Jet OLEDB 4.0 or higher driver installed.

Console

- ◆ A VGA, SVGA, or Multisync monitor capable of the highest resolution that you will be using on any computer in the installation.
- ◆ A USB or PS/2 mouse
- ◆ A USB or PS/2 keyboard

Computers

The following equipment must be installed on the computers that connect to the KH1508Ai or KH1516Ai's KVM ports:

- ◆ A VGA, SVGA or Multisync port
- ◆ A USB Type-A port and USB host controller (for USB KVM Adapter Cable Connection, see below)
- ◆ 6-pin mini-DIN keyboard and mouse ports (for PS/2 KVM Adapter Cable Connection, see below)

KVM Adapter Cables

- ♦ Cat 5e/6 cable is required to connect the KH1508Ai / KH1516Ai to one of the KVM adapter cables.
- ♦ The following KVM adapter cables are required for use with the KH1508Ai / KH1516Ai:

Function	Module
Connect to devices with PS/2 ports	KA7920 / KA7520 / KA7120 KA9520 / KA9120
Connect to devices with USB ports	KA7166 / KA7168 / KA7169 KA7970 / KA7570 / KA7170 KA9570 / KA9170
Connect to Sun Legacy systems (with 13W3 port)	KA9130 / KA7130
Connect to Sun USB systems	KA9170 / KA7170
Connect to serial based devices	KA9140

- Note:**
1. KVM adapter cables are referred to as *I/O Modules* in some dialog boxes.
 2. The following cable models support the Adapter Cable ID function:
KA7166 / KA7168 / KA7169 / KA7920 / KA7970 / KA7520 / KA7570
/ KA7120 / KA7130 / KA7170.

Adapter Cable Resolutions

The table below provides the maximum resolutions available for each KVM adapter cable.

Model No.	Computer Ports	Video Resolution
KA71xx	KA7120	2 x PS/2, 1 x HDB-15
	KA7130	1 x Min Din 8 Male
	KA7166	2 x USB Type A, 1 x DVI-D
	KA7168	2 x USB Type A, 1 x HDMI
	KA7169	2 x USB Type A, 1 x DisplayPort
	KA7170	1 x USB Type A, 1 x HDB-15
KA75xx	KA7520	2 x PS/2, 1 x HDB-15
	KA7570	1 x USB, 1 x HDB-15
KA79xx	KA7920	2 x PS/2, 1 x HDB-15
	KA7970	1 x USB, 1 x HDB-15
KA91xx	KA9140	N/A

Operating Systems

Supported operating systems are shown in the table, below:

OS		Version
Windows		NT ¹ , 2000, XP, 2003 Server, 2008 Server, Vista
Linux ²	RedHat	9.0, Fedora and higher, RHEL AS 4, RHEL 5
	SuSE	10 and higher, OpenSUSE 10.2; SLES 10 SP1
	Debian	3.1, 4.0
	Ubuntu	7.04, 7.10
UNIX	IBM	AIX4.3, 5L (V5.2,V5.3), V6 (V6.1)
	FreeBSD	5.5, 6.1, 6.2
Novell	Netware	5.0 and higher
Sun		Solaris 8, 9, 10
Mac		9.0, 9.1, 10.1, 10.2, 10.3, 10.4 , 10.5
DOS		6.2 and higher ¹

¹ Does not support USB. ² Kernels below 2.6 do not support USB 2.0

Components

Front View

KH1508Ai

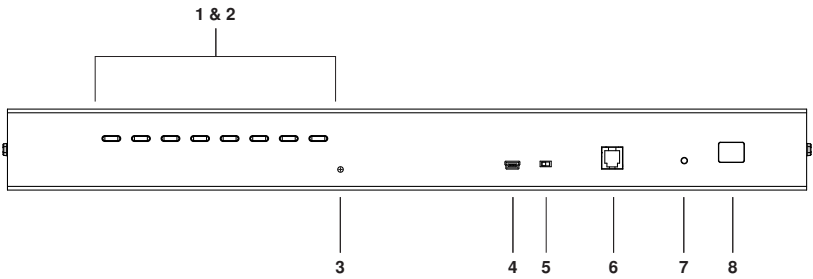

KH1516Ai

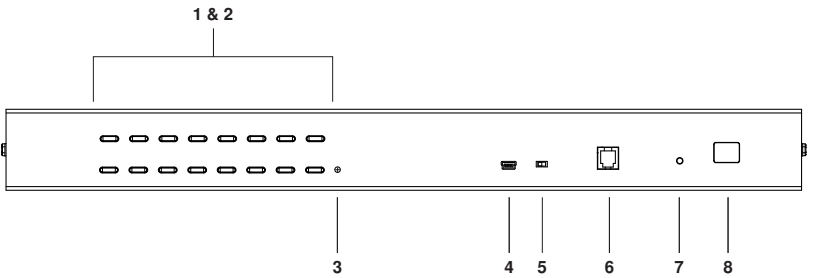

No.	Component	Description
1	port selection pushbuttons	<ul style="list-style-type: none"> ◆ Press a pushbutton to give the KVM focus to the computer attached to its corresponding port. ◆ Simultaneously pressing pushbuttons 1 and 2 for 3 seconds performs a Keyboard and Mouse Reset. ◆ Simultaneously pressing pushbuttons 15 and 16 starts Auto Scan Mode.
2	port LEDs	<p>The port LEDs are built into the port selection pushbuttons. The left ones are the <i>On Line</i> LEDs; the right ones are the <i>Selected Port</i> LEDs:</p> <ul style="list-style-type: none"> ◆ An ONLINE LED lights green to indicate that the computer attached to its corresponding port is up and running. A flashing LED indicates that the Port is being used for cascading to another switch. ◆ A SELECTED LED lights orange to indicate that the computer attached to its corresponding port is the one that has the KVM focus. The LED is steady under normal conditions, but flashes when its port is accessed under Auto Scan Mode.
3	reset button	<p>Pressing this button in performs a system reset.</p> <p>Note: The switch is recessed and must be pushed with a thin object - such as the end of a paper clip, or a ballpoint pen.</p>
4	laptop USB console port	<p>This USB Mini-B- port allows a laptop to be connected for local access and control. See <i>Laptop USB Console Login</i>, page 52 for further details.</p>
5	firmware upgrade recovery switch	<p>During normal operation and while performing a firmware upgrade, this switch should be in the NORMAL position. If a firmware upgrade operation does not complete successfully, this switch is used to perform a firmware upgrade recovery.</p>
6	firmware upgrade port	<p>The firmware upgrade cable that transfers the firmware upgrade data from the administrator's computer to the KH1508Ai / KH1516Ai (see page 36), plugs into this RJ-11 connector.</p>
7	power LED	<p>Lights to indicate that the KH1508Ai / KH1516Ai is powered up and ready to operate.</p>
8	station ID LED	<p>The KH1508Ai / KH1516Ai's station ID is displayed here. If this is a single station installation (see page 16), or the first station on a daisy chained installation (see page 20), the KH1508Ai / KH1516Ai has a station ID of 01.</p> <p>On a daisy chained installation, the KH1508Ai / KH1516Ai auto-senses its position and displays the station ID that corresponds to its place in the chain. (see <i>Port ID Numbering</i>, page 26, for details).</p>

Rear View

KH1508Ai

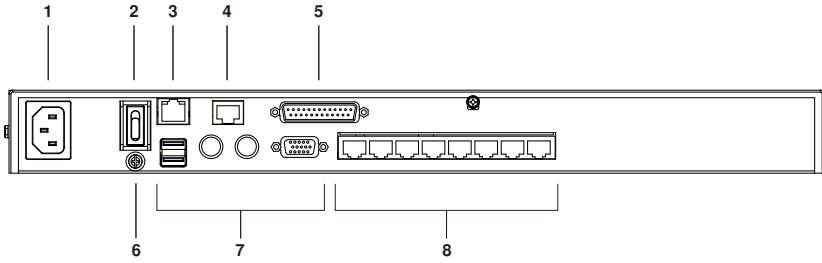

KH1516Ai

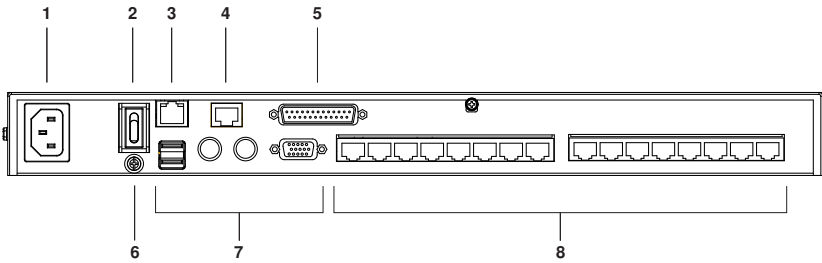

No.	Component	Description
1	power socket	The AC power cord plugs in here.
2	power switch	This rocker switch powers the unit on and off.
3	LAN port	The cable that connects the KH1508Ai / KH1516Ai to the Internet plugs in here. The LEDs indicate data transmission speed: orange for 10 Mbps; green for 100 Mbps.
4	PoN port	This connector is provided for a Power over the Net™ (PoN) unit to plug into. A PoN device allows computers attached to the KH1508Ai / KH1516Ai to be booted remotely over the net. Contact your dealer for more details.
5	daisy chain port	When daisy chaining units (see <i>Daisy Chaining</i> , page 20), the daisy chain cable plugs in here.
6	grounding terminal	The wire used to ground the unit connects here.
7	local console port section	If this is a single station installation, or if this is the first station of a daisy chained installation, the keyboard, monitor, and mouse that make up the local console plug in here.
8	KVM port section	The Cat 5e/6 cables that link to the KVM Adapter Cables (which link to the computers) plug in here.

This Page Intentionally Left Blank

Chapter 2

Hardware Setup

Overview

For convenience and flexibility that allows mixing the PS/2, USB, and serial device interfaces, as well as multiple platforms, the KH1508Ai / KH1516Ai's design utilizes KVM Adapter Cables (CPU Modules), that serve as intermediaries between the switch and the connected devices (refer to the installation diagram on page 17).

A separate KVM Adapter Cable is required for each computer or device connection. See *KVM Adapter Cables*, page 6 for the model numbers.

Before You Begin



1. Important safety information regarding the placement of this device is provided on page 165. Please review it before proceeding.
2. Make sure that power to all the devices you will be connecting up has been turned off. You must unplug the power cords of any computers that have the Keyboard Power On function.
3. Please operate the device with caution when under high environmental temperatures, as the surface of the device may become overheated under such conditions. For instance, the surface temperature of the device may reach 70 °C (158 °F) or higher when the environmental temperature reaches close to 50 °C (122 °F).

Stacking and Rack Mounting

The KH1508Ai / KH1516Ai can be stacked on the desktop or rack mounted at the front or rear of the rack. The following sections take you through the procedures for each method.

Stacking

The KH1508Ai / KH1516Ai can be placed on any appropriate level surface that can safely support its weight plus the weight of its attached cables. To place the KH1508Ai / KH1516Ai, or to stack units if you are daisy chaining them, remove the backing material from the bottom of the rubber feet that came with this package, and stick them onto the switch's bottom panel at the corners, as shown in the diagram, below:

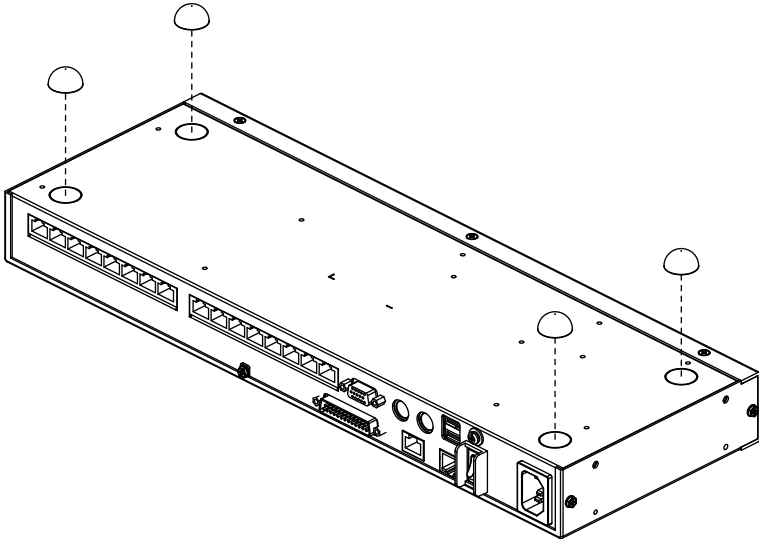

Note: To ensure adequate ventilation, allow at least 5.1 cm on each side, and 12.7cm at the back for power cord and cable clearance.

Rack Mounting

The KH1508Ai / KH1516Ai can be mounted in a 19" (1U) racks. The mounting brackets can screw into either the front or the back of the unit so that it can attach to the front or the back of the rack. To rack mount the unit:

1. Remove the screws at the front or the rear, as shown in the diagram below.

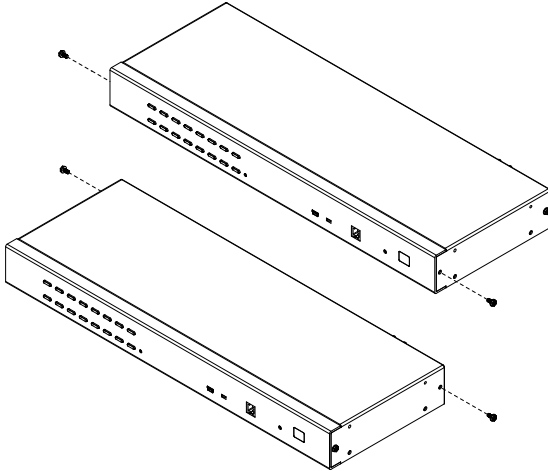

2. Screw the mounting brackets into the sides of the unit at the front or the rear, as shown in the diagram below.

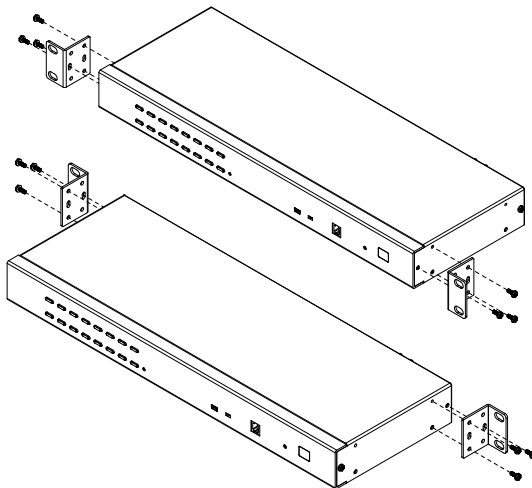

3. Slide the unit into the front or rear of the rack and secure it to the rack.

Single Station Installation

In a single stage installation, there are no additional KVM switches daisy chained down from the KH1508Ai / KH1516Ai. To set up a single stage installation, refer to the installation diagrams starting on page 17. The numbers in the diagrams correspond with the numbers of the instruction steps, below:

1. Ground the KH1508Ai / KH1516Ai by connecting one end of a grounding wire to the grounding terminal, and the other end of the wire to a suitable grounded object.

Note: Do not omit this step. Proper grounding helps to prevent damage to the unit from power surges or static electricity.

2. Plug the console keyboard, monitor, and mouse into the unit's console ports. Ports are color coded and marked with icons for easy identification.

Note: You can use any combination of keyboard and mouse connections.

3. If you are using a laptop USB console to control the KH1508Ai / KH1516Ai locally, use the laptop USB cable included in the package to connect the laptop to the KH1508Ai / KH1516Ai's laptop USB console port, located on the unit's front panel.
4. Use Cat 5e/6 cable to connect any available KVM port to a KVM adapter cable that is appropriate for the computer you are installing (see *KVM Adapter Cables*, page 6 for details).

Note: To support a resolution of 1280x1024@75Hz, the recommended maximum distance between the unit and the KVM adapter cable is 50 meters; to support a resolution of 1600x1200@60Hz, the recommended maximum distance is 40 meters.

5. Connect the KVM adapter cable to the computer.
Plug the connectors on the KVM adapter cable into the appropriate ports of the computer you are installing. (See *KVM Adapter Cable Installation Diagrams*, page 18 for connection examples.)
6. Plug the LAN or WAN cable into the KH1508Ai / KH1516Ai's LAN port.
7. Plug the female end of the power cord into the KH1508Ai / KH1516Ai's power socket; plug the male end into an AC power source.

After the KH1508Ai / KH1516Ai is cabled up, you can turn on the power. After it is powered up, you can turn on the servers.

Single Stage Installation Diagram

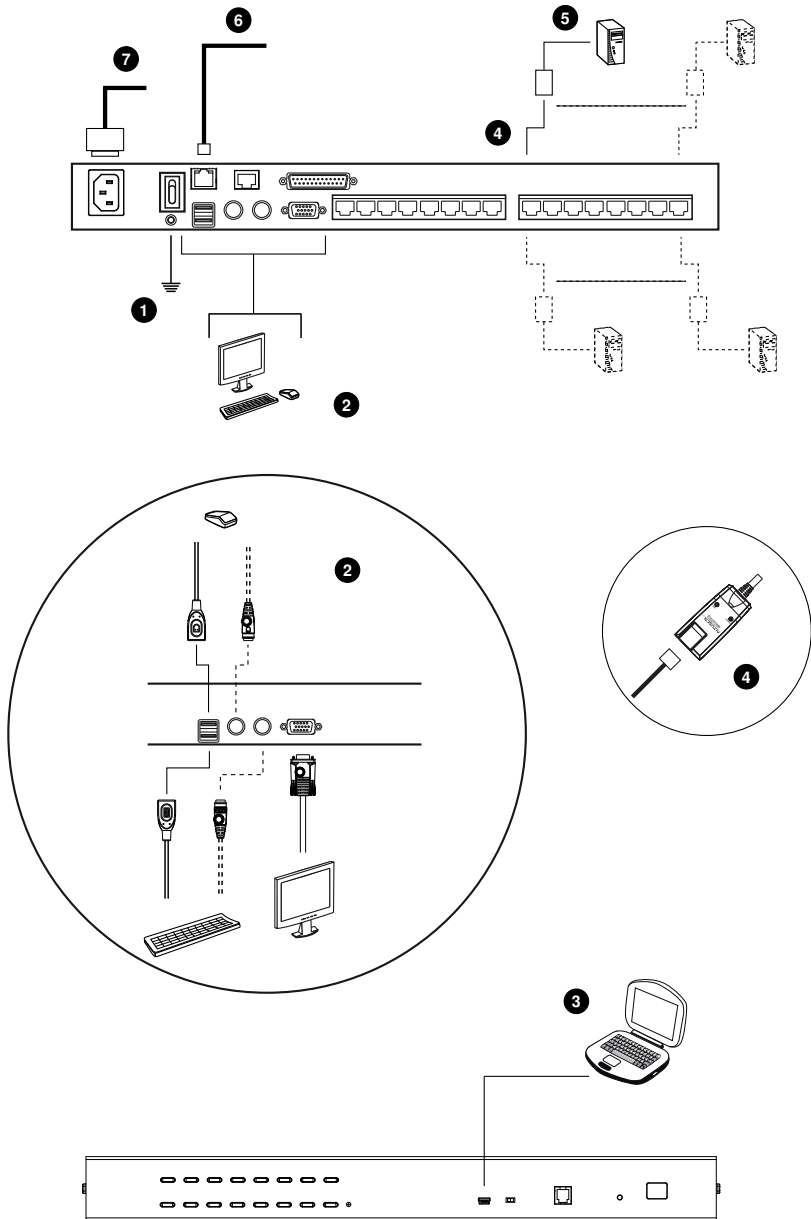

KVM Adapter Cable Installation Diagrams

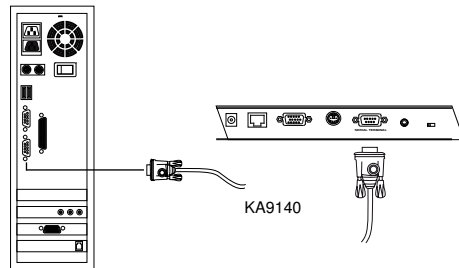
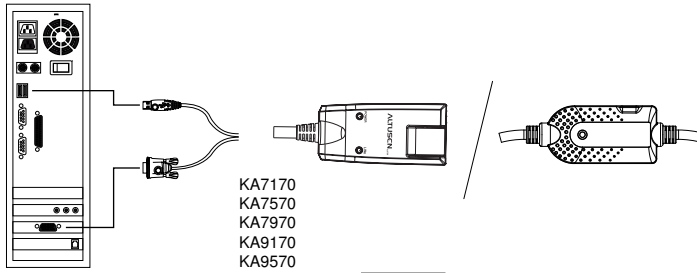
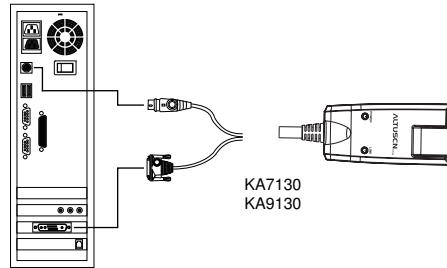
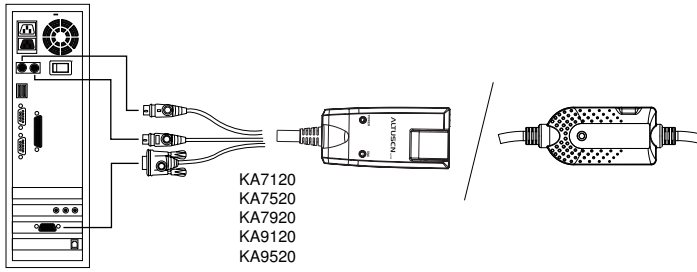

KVM Adapter Cable Installation Diagrams cont.

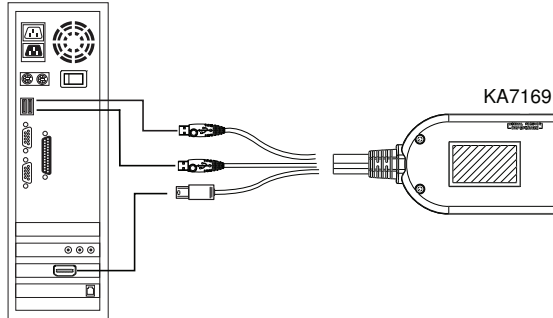
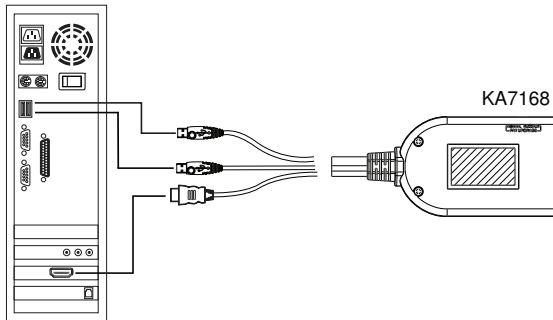
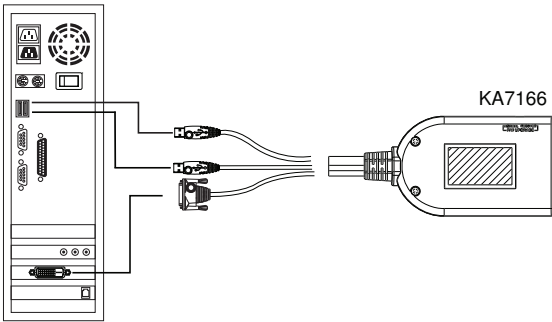

Daisy Chaining

To control even more computers, up to 15 additional KVM switches can be daisy chained from the original KH1508Ai or KH1516Ai. As many as 256 computers can be controlled from a single console in a complete installation.

Note: Please see the table, *Supported Devices*, page 188, for a list of ATEN switches that can be installed on a KH1508Ai / KH1516Ai daisy chain.

Tables showing the relation between the number of computers and the number of KH1508Ai / KH1516Ai units needed to control them are provided on page 187.

To set up a daisy chained installation, do the following:

1. Use a daisy chain cable set to connect the *chain out* port of the first station KH1508Ai / KH1516Ai unit to the *chain in* port of the chained station unit (first station out to second station in, second station out to third station in, etc.).

Note: 1. You cannot use the chain in port of the first station, since it is the highest level first station.

2. Daisy chain cable sets require a separate purchase. Contact your dealer for details.
-

2. Cable up the computers and the switch according to the information provided under *Single Station Installation*, page 16.
3. Repeat the above for any other switches you want to add to the chain.
4. Power up the installation according to the following procedure:
 - a) Plug in the power cord for the first station. Wait for the unit to ascertain its station ID and display it on the Station ID LED. (The station ID for the first stage unit is 01, the ID for the second stage unit is 02, the ID for the third stage unit is 03, etc.)
 - b) Power on each station on the installation in turn (second station, then third station, etc.). In each case, wait for the station ID to be ascertained and displayed before powering on the next station.
 - c) After all the stations are up, power on the computers.

Daisy Chain Installation Diagram

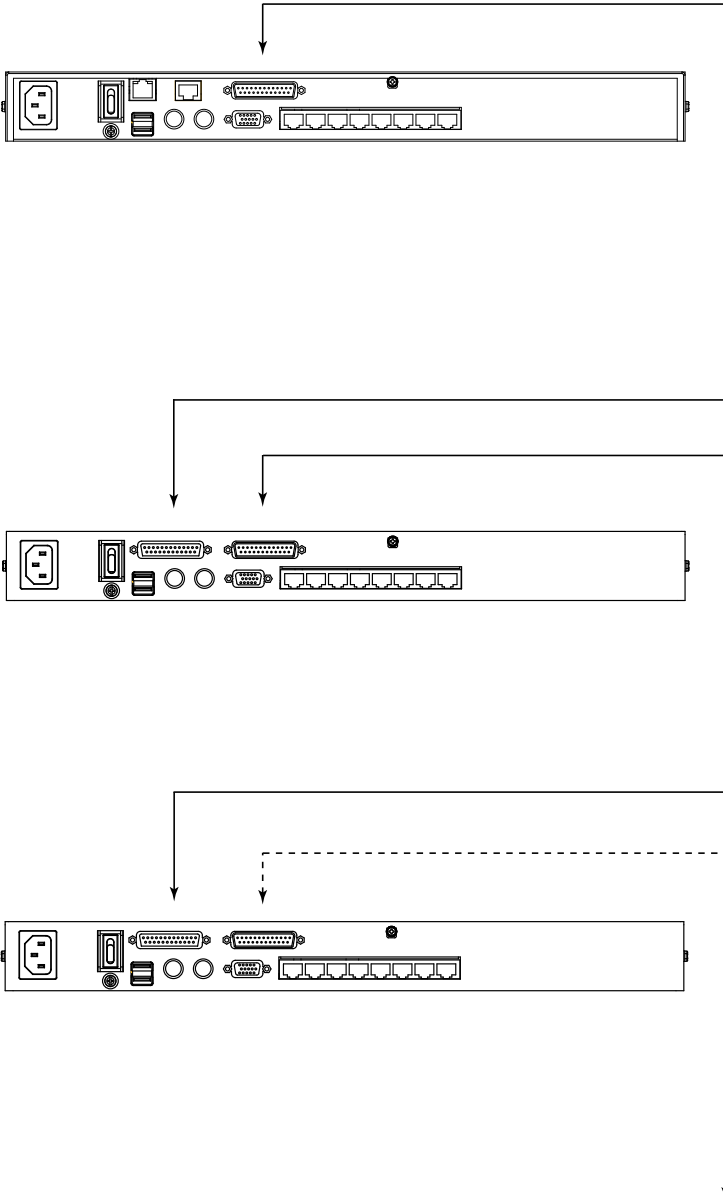

This Page Intentionally Left Blank

Chapter 3

Basic Operation

Port Selection

KH1508Ai / KH1516Ai installations provide three methods to obtain instant access to any computer in your installation: Manual, OSD, and *Hotkey*.

Manual

For manual port selection, simply press the Port Switch that corresponds to the device you wish to access.

OSD / GUI

The KH1508Ai / KH1516Ai provides menu driven interfaces to the computer switching procedure. There are two systems: A text-based OSD when you log in from a local console; and a graphical user interface (GUI) when you log in remotely over the Internet or locally via a Laptop console. Local console OSD operation is discussed in the next chapter; GUI operation is discussed from Chapter 5 onwards for Internet browser, Laptop, and Windows and Java logins.

Manufacturing Number

The “MFG Number” (Manufacturing Number) is an internal serial number used by ATEN’s factory and technical support staff to identify products. This number does not affect products’ warranty. If your product requires after-sales services, you may provide the MFG Number to ATEN’s sales or technical support staff to identify the product and model number.

Keyboard Hotkeys

Hotkeys allow you to conveniently provide KVM focus to a particular computer from the local console keyboard, instead of having to manually select them by pressing Port Selection switches. See *Hotkey Port Control*, page 41, for details.

Hot Plugging

The KH1508Ai / KH1516Ai supports hot plugging – components can be removed and added back into the installation by unplugging and replugging their cables from their ports without the need to shut the unit down. In order for hot plugging to work properly, however, the procedures described below must be followed.

Hot Plugging Stations

You can switch station positions by simply unplugging from the old parent and plugging into a new one. After you do, in order for the OSD menus to correspond to the change, you must reset the OSD. See *RESET STATION IDS*, page 36, for details.

Hot Plugging KVM Ports

After switching KVM ports, in order for the OSD menus to correspond to the change, you must manually reconfigure the OSD information for the new Port information. See *F3: SET*, page 32, and the Port Setting selections under the *F4 ADM* function, page 35, for details.

Note: If the computer's Operating System doesn't support hot plugging, this function may not work properly.

Hot Plugging Console Ports

Keyboard, monitor, and mouse can all be hot plugged. When hot plugging the mouse:

- ♦ You may unplug the mouse and plug it back in again (to reset the mouse, for example), as long as you use the *same* mouse.
- ♦ If you plug in a different mouse, all the stations and all the computers on the installation must be shut down for 10 seconds, then restarted following the Power Up Sequence described under Step 6 on page 20.

Note: If, after hot plugging (or at any other time), there is no response to keyboard and/or mouse input, perform a Keyboard and Mouse Reset by pressing in the Reset switch (see page 9).

The Adapter ID Function

Adapter Cable information (the Adapter ID, port name, OS, keyboard language, and access mode), is stored on the adapter. The switch's *Adapter ID* function takes this information and stores it along with the adapter cable's configuration information (access rights, etc.), in its database – so that when you move a server together with its adapter cable from one port to another, you don't have to reconfigure its settings – the Adapter ID function restores them at the new location. The only change is in the port number.

When moving the server and adapter cable to another switch, however, only the information that is stored on the adapter is retained. For the other settings you must either reconfigure them, or use the *Backup/Restore* function (see page 143) to restore them.

Since port settings are stored with the adapter, if you move a server to a new port without its original adapter; or if you connect a different server to the adapter, you must manually reconfigure the port settings for the new server. See *Port Access*, page 93 for port configuration details.

Powering Off and Restarting

If it becomes necessary to power off the KH1508Ai / KH1516Ai, or if the switch loses power and needs to be restarted, before starting it back up you must follow these procedures:

1. Shut down all the computers that are attached to it.

Note: You must unplug the power cords of any computers that have the Keyboard Power On function.

2. Wait 10 seconds then power it back on. If you have shut down more than one station, power up the highest station first and work your way down to the lowest one. Wait for each station to display its Station ID on the front panel LED before powering on the next one.
3. After the station(s) is (are) up, power the computers back on.

Port ID Numbering

Each computer on the installation is assigned a unique Port ID. The Port ID is a one or two segment number that is determined by the Stage Level and KVM Port number of the KVM switch that the computer is connected to.

The first segment represents the KVM Port number of the First Stage unit; the second segment represents the KVM Port number of the Second Stage unit.

A computer attached to a First Stage unit has a one segment Port ID (from 1–16) that corresponds to the KVM Port number that it is connected to.

A computer attached to a Second Stage unit has a two segment Port ID:

- ♦ The second segment (from 1–16), represents the KVM Port number on the Second Stage unit that the computer is connected to. The first segment (from 1–16) represents the KVM Port number on the First Stage unit that the Second Stage unit links back to.
- ♦ For example, a Port ID of 12–3 refers to a computer that is connected to KVM Port 3 of a Second Stage unit that links back to KVM Port 12 of the First Stage unit.

Chapter 4

OSD Operation

OSD Overview

The On Screen Display (OSD) is a menu driven method to handle computer control and switching operations. All procedures start from the OSD Main Screen. To display the Main Screen, tap the OSD hotkey twice.

The default hotkey is [Scroll Lock]. You can change the hotkey to the Ctrl key or the Alt key if you like (see *OSD HOTKEY*, page 32).

-
- Note:**
1. If you use the Ctrl or Alt key method you must press the same Ctrl or Alt key both times.
 2. Once you start the OSD, the keyboard lock will be controlled by the device. The number lock and caps lock will always be on when the OSD is being accessed.
-

The OSD incorporates a two level (administrator / user) password system. Before the OSD Main Screen comes up, a login dialog box appears that asks for a username and password. You must provide a valid username and password in order to continue.

The first time that the OSD is accessed, you must use the default username and password. The default username is *administrator*; the default password is *password*. For security purposes, we strongly recommend changing these to something unique after you log in for the first time.

After logging in with the default username and password, the OSD Main Screen opens in Administrator mode. In this mode, you have administrator privileges, with access to all administrator and user functions, and can set up operations (including password authorization for the future), as you would like.

When you invoke the OSD, a screen similar to the one below appears:

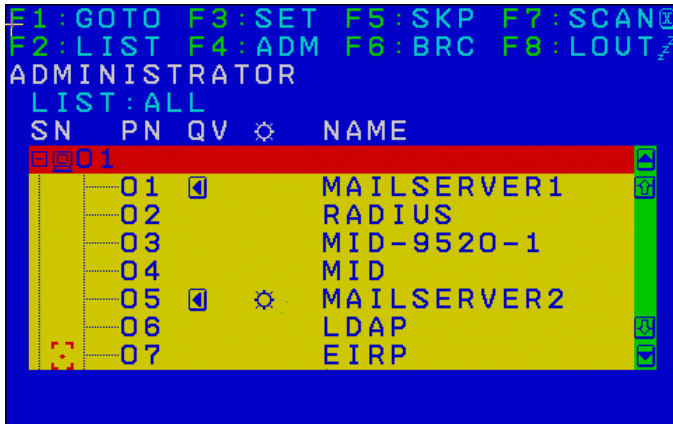

Note: The diagram depicts the Administrator's Main Screen. The User Main Screen does not show the F4 and F6 functions, since these are reserved for the administrator and can't be accessed by ordinary users.

OSD Navigation

- ◆ To dismiss the menu, and deactivate the OSD, click the **X** at the upper right corner of the OSD Window or press **Esc**.
- ◆ To Logout click **F8** or the **ZZZ** symbol at the top of the Main Screen, or press **[F8]**.
- ◆ The OSD uses a tree view. To see the ports for a particular station, click the plus sign [**+**] in front of the station number. The port number list drops down. To dismiss the list, click the circle symbol [**o**] in front of the station number.
- ◆ To move up or down through the list one line at a time, click the up and down triangle symbols (**▲▼**) or use the up and down arrow keys. If there are more list entries than there is room for on the Main Screen, the screen will scroll.
- ◆ To move up or down through the list one screen at a time, click the up and down arrow symbols (**↑↓**), or use the [Pg Up] and [Pg Dn] keys. If there are more list entries than there is room for on the Main Screen, the screen will scroll.
- ◆ To bring the KVM focus to a port, double-click it, or move the highlight bar to it and then press **[Enter]**.
- ◆ After executing any action, you automatically go back to the menu one level above.

OSD Main Screen Headings

Heading	Explanation
SN-PN	This column lists the port ID numbers (station number-port number) for all the KVM ports on the installation. The simplest method to access a particular computer is to click it, or move the highlight bar to it, and then press [Enter] .
QV	If a port has been selected for Quick View scanning (see <i>SET QUICK VIEW PORTS</i> , page 34), an arrowhead displays in this column.
	The computers that are powered on and are online have a sun symbol in this column.
NAME	If a port has been given a name (see <i>EDIT PORT NAMES</i> , page 35), its name appears in this column.

OSD Functions

OSD functions are used to configure and control the OSD. For example, you can rapidly switch to any port, scan selected ports only, limit the list you wish to view, designate a port as a Quick View Port, create or edit a port name, or make OSD setting adjustments.

To access an OSD function:

1. Either click a function key field at the top of the Main Screen, or press a function key on the keyboard.
2. In the submenus that appear make your choice either by double clicking it, or moving the highlight bar to it, and then pressing [**Enter**].
3. Press [**Esc**] to return to the previous menu level.

F1: GOTO

Accessing the GOTO function allows you to switch directly to a port either by keying in the port's name or its port ID.

- ♦ To use the Name method, key in **1**, key in the port's name, and then press [**Enter**].
- ♦ To use the Port ID method, key in **2**, key in the port ID, and then press [**Enter**].

Note: You can key in a partial name or port ID. The screen will show all the computers that the user has *View* rights to, that match the name or port ID pattern, regardless of the current *List* settings (see *F2: LIST*, page 31, for details).

To return to the OSD Main Menu without making a choice, press [**Esc**].

F2: LIST

Many of the switch's OSD functions only operate on the computers currently selected for listing on the Main Screen. Accessing this function lets you broaden or narrow the scope of ports that get listed. The submenu choices and their meanings are given in the table below:

Choice	Meaning
ALL	Lists all of the ports on the installation.
QUICK VIEW	Lists only the ports that have been selected as Quick View Ports (see <i>SET QUICK VIEW PORTS</i> , page 34).
POWERED ON	Lists only the ports that have attached computers Powered On.
QUICK VIEW + POWERED ON	Lists only the ports that have been selected as Quick View Ports (see <i>SET QUICK VIEW PORTS</i> , page 34), and that have their attached computers Powered On.

Move the highlight bar to the choice you want, then press **[Enter]**. An icon appears before the choice to indicate that it is the currently selected one.

F3: SET

Accessing this function allows the administrator and each user to set up an individual working environment. A separate profile for each operator is stored by the OSD and is activated according to the username provided during login.

To change a setting:

1. Double-click it; or move the highlight bar to it, then press **[Enter]**.
2. After you select an item, a submenu with further choices appears. To make a selection, either double click it; or move the highlight bar to it, then press **[Enter]**. An icon appears before the selected choice to indicate which one it is. The settings are explained in the following table:

Setting	Function
OSD HOTKEY	<p>Selects which hotkey activates the OSD function: [Scroll Lock] [Scroll Lock]; [Ctrl] [Ctrl] or [Alt] [Alt].</p> <p>Since the [Ctrl] or [Alt] key combinations may conflict with programs running on the computers, the default is the [Scroll Lock] combination.</p>
PORT ID DISPLAY POSITION	<p>Allows you to position where the port ID appears on the monitor. The default is the upper left corner, but you can choose to have it appear anywhere on the screen.</p> <p>Use the mouse or the arrow Keys plus Pg Up, Pg Dn, Home, End, and 5 (on the numeric keypad with Num Lock off), to position the port ID display, then click or press [Enter] to lock the position and return to the Set submenu.</p> <p>Note: The setting affects the currently selected port. If you don't want to use the default position, you must change the setting for each port individually.</p>
PORT ID DISPLAY DURATION	<p>Determines how long a port ID displays on the monitor after a port change has taken place. There are two choices: 3 seconds and Off.</p>
PORT ID DISPLAY MODE	<p>Selects how the port ID is displayed: the port number alone (PORT NUMBER); the port name alone (PORT NAME); or the port number plus the port name (PORT NUMBER + PORT NAME). The default is PORT NUMBER + PORT NAME.</p>
SCAN DURATION	<p>Determines how long the focus dwells on each port as it cycles through the selected ports in Auto Scan mode (see <i>F7: SCAN</i>, page 40). Key in a value from 1–255 seconds, then press [Enter]. Default is 5 seconds; a setting of 0 disables the Scan function.</p>

Setting	Function
SCAN/SKIP MODE	<p>Selects which computers will be accessed under Skip mode (see <i>F5: SKP</i>, page 38), and Auto Scan mode (see <i>F7: SCAN</i>, page 40). Choices are:</p> <p>ALL – All the ports which have been set Accessible;</p> <p>QUICK VIEW – Only those ports which have been set Accessible and have been selected as Quick View Ports (see <i>SET QUICK VIEW PORTS</i>, page 34);</p> <p>POWERED ON – Only those ports which have been set Accessible and are Powered On;</p> <p>QUICK VIEW + POWERED ON – Only those ports which have been set Accessible and have been selected as Quick View Ports and are Powered On. The default is ALL.</p>
SCREEN BLANKER	<p>If there is no input from the console for the amount of time set with this function, the screen is blanked. Key in a value from 1–30 minutes, then press [Enter]. A setting of 0 disables this function. The default is Off.</p>
HOTKEY COMMAND MODE	<p>Enables / Disables the Hotkey function (see <i>OSD Operation</i>, page 27), in case a conflict with programs running on the computers occurs. The default is On.</p>
HOTKEY	<p>This setting selects the Hotkey invocation keys (see <i>Invoking Hotkey Mode</i>, page 42). Choices are [NUM LOCK] + [-], or [CTRL] + [F12]. The default is [NUM LOCK] + [-].</p>
OSD LANGUAGE	<p>Sets the language that the OSD displays in. Choices are: English, German, Japanese, Simplified Chinese and Traditional Chinese. The default is English.</p>
SET CONSOLE KEYBOARD	<p>Sets the keyboard language mapping of the console keyboard. The default is Auto. If the switch does not automatically receive language mapping from the keyboard, it will set to English (US).</p>
SET LOGOUT TIMEOUT	<p>If there is no input from the console for the amount of time set with this function, the operator is automatically logged out. A login is necessary before the console can be used again.</p> <p>This enables other operators to gain access to the computers when the original operator is no longer accessing them, but has forgotten to log out. To set the timeout value, key in a number from 1–180 minutes, then press [Enter]. If the number is 0 (zero), this function is disabled. Default is Off.</p>
ACTIVATE BEEPER	<p>Choices are Y (for Yes), or N (for No). When activated, the beeper sounds whenever a port is changed, when activating the Auto Scan function (see <i>F7: SCAN</i>, page 40), or an invalid entry is made on an OSD menu. The default is On.</p>

Setting	Function
SET QUICK VIEW PORTS	<p>This function lets the administrator select which ports to include as Quick View ports.</p> <ul style="list-style-type: none"> ◆ To select/deselect a port as a Quick View Port, use the navigation keys to move the highlight bar to it, then press the [Spacebar]. ◆ When a port has been selected as a Quick View Port, an arrowhead displays in the QV column of the LIST on the Main Screen to indicate so. When a port is deselected, the arrowhead disappears. ◆ If one of the Quick View options is chosen for the LIST view (see <i>F2: LIST</i>, page 31), only a port that has been selected here will display on the List. ◆ If one of the Quick View options is chosen for Auto Scanning (see <i>SCAN/SKIP MODE</i>, page 33), only a port that has been selected here will be Auto Scanned. <p>The default is for no ports to be selected.</p>
PREFERRED RESOLUTION	<p>This function allows you to set a resolution that the switch sends to the KVM adapter cables. The adapter cables provide the connected computer's video card information about the monitor connected to the switch. This affects the video quality of the console monitor. Choices are:</p> <ul style="list-style-type: none"> ◆ MONITOR DEFAULT SETTING – Sends the EDID information provided by the display connected to the console port – to the KVM adapter cables. ◆ Alternative Resolution – Sends an alternative resolution (EDID information) to the KVM adapter cables. Select a resolution that best suits the video display on the monitor connected to the console port. <p>Note: We strongly recommend using the Monitor Default Setting. Only use an alternative resolution if the video quality on the console monitor isn't displaying properly.</p>

F4: ADM

F4 is an administrator only function. Accessing this function allows the administrator to configure and control the overall operation of the OSD. To change a setting double click it; or use the up and down arrow keys to move the highlight bar to it, then press **[Enter]**.

After you select an item, a submenu with further choices appears. Double click the choice you want, or move the highlight bar to it, then press **[Enter]**. An icon appears before the selected choice. The settings are explained in the table on the next three pages:

Setting	Function
SET IP ADDRESS	<p>This function is used to select whether to assign the KH1508Ai / KH1516Ai's IP address automatically (DHCP), or to give it a fixed IP address.</p> <ul style="list-style-type: none"> ◆ Enable DHCP to assign the IP address automatically. ◆ Disable DHCP to assign a fixed IP address and specify the IP, Mask, and Gateway in the appropriate fields. <p>Note: The default setting for DHCP is disabled.</p>
EDIT PORT NAMES	<p>To identify which computer is attached to a particular port, every port can be assigned a name. This function allows the administrator to create, modify, or delete port names. To assign a port name:</p> <ol style="list-style-type: none"> 1. Click the port you want, or use the navigation keys to move the highlight bar to it, then press [Enter]. 2. Key in the new port name, or modify/delete the old one. The maximum number of characters allowed for the port name is 14. Legal characters include: <ul style="list-style-type: none"> ◆ All alpha characters: A–Z* ◆ All numeric characters: 0–9 <p>*You can enter the port names in either upper or lower case however the OSD displays the port name only in UPPERCASE.</p> 3. When you have finished editing, press [Enter] to have the change take effect. To abort the change, press [Esc].
RESTORE DEFAULT VALUES	<p>This function is used to undo all changes and return the setup to the original factory default settings (see <i>OSD Factory Default Settings</i>, page 188) – except for the <i>Names</i> settings that were assigned to the ports, which are saved.</p>
CLEAR THE NAME LIST	<p>This function clears the port name list.</p>

Setting	Function
RESET STATION IDS	<p>If you change the position of one of the stations in the daisy chain, the OSD settings will no longer correspond to the new situation. This function directs the OSD to rescan the station positions of the entire installation and updates the OSD so that the OSD station information corresponds to the new physical layout.</p> <p>Note: Only the station numbers get updated. Except for the port names, all administrator settings (such as Set Accessible Ports, Set Quick View Ports, etc.), for all of the computers affected by the change, have to be manually redone.</p>
SET OPERATING SYSTEM	<p>Specifies the operating platform of the computer attached to each port. You must configure each port on the installation. For each port, press the [Spacebar] to cycle through the choices (PC, Mac or Sun). Repeat until all the ports have been set, then press [Esc]. The default is PC.</p> <p>Note: If you are installing a Sun or Mac computer it may not boot when you run it for the first time unless you first set the correct operating system for the port it is connected to.</p>
SET CAT 5 LENGTH	<p>Lets you specify how long the Cat 5e/6 cable between the port and the KVM adapter cable is. Press [Spacebar] to cycle through the cable length settings:</p> <p style="padding-left: 20px;">S: Short – for up to 25 m M: Medium – for between 20 and 35 m L: Long – for above 35 m</p> <p>An S, M, or L appears next to the port to indicate the choice.</p>
SET KEYBOARD LANGUAGE	<p>Sets the keyboard language layout for the computers attached to each port. Press [Spacebar] to cycle through the choices: The default is English (US).</p>
FIRMWARE UPGRADE	<p>In order to upgrade the KH1508Ai / KH1516Ai and adapter cable firmware (see <i>Mainboard and KVM Adapter Cable Firmware Upgrade</i>, page 139) you must first enable <i>Firmware Upgrade</i> mode with this setting.</p> <p>When you bring up this menu, the current firmware version levels display. Select Y to enable Firmware Upgrade mode, or N to leave this menu without enabling it.</p>
ADAPTER UPGRADE	<p>This function allows the administrator to check the firmware version of the KVM adapter cable. When you bring up this menu, the current firmware version levels display. See <i>FIRMWARE UPGRADE</i>, above, also.</p>

Setting	Function
SET VIDEO HV MODE	<p data-bbox="306 161 969 256">This setting selects the video mode (separate or composite video sync signals) the port(s) (internal/external) is using. Press [Enter] to enter this setting and see a list of ports. In the list, the “Mode” column will display the video mode choices, these are:</p> <ul data-bbox="336 272 530 323" style="list-style-type: none"><li data-bbox="336 272 530 296">S Separate (default)<li data-bbox="336 300 463 323">C Composite <p data-bbox="336 344 969 395">Use the [Spacebar] to cycle through the choices. Changes will not be saved until you exit to the main menu.</p> <p data-bbox="306 405 951 456">Note: Some old adapters may not support HV mode and the “Mode” column will be empty.</p>

F5: SKP

This function enables you to easily skip backward or forward, switching the console focus from the currently active KVM Port to the previous or next available one.

- ◆ The selection of computers to be available for Skip mode switching is made with the *Scan/Skip* mode setting under the **F3 SET** function (see page 33).
- ◆ When you are in Skip mode, press:
 - ← To skip to the previous port in the List.
 - To skip to the next port in the List.
 - ↑ To skip to the last port of the previous station in the List.
 - ↓ To skip to the first port of the next station in the List.

Note: When you skip, you only skip to the previous or next available computer that is in the *Scan/Skip* mode selection (see page 33).

- ◆ If a port has been selected for *Scan/Skip* mode, when the focus switches to that port a left/right triangle symbol appears before its port ID display.
- ◆ While Skip mode is in effect, the console will not function normally. You must exit Skip mode in order to regain control of the console.
- ◆ To exit Skip mode, press the [Spacebar] or [Esc].

F6: BRC

F6 is an administrator only function. When this function is in effect, commands sent from the console are broadcast to all available computers on the installation.

This function is particularly useful for operations that need to be performed on multiple computers, such as performing a system wide shutdown, installing or upgrading software, etc.

- ◆ While BRC mode is in effect, a speaker symbol appears before the port ID display of the port that currently has the console focus.
- ◆ While BRC mode is in effect, the mouse will not function normally. You must exit BRC mode in order to regain control of the mouse.
- ◆ To exit BRC mode, invoke the OSD (with the OSD Hotkey), then click the **F6** field, or press [F6], to turn BRC mode off.

F7: SCAN

This function automatically switches among the available computers at regular intervals so that you can monitor their activity without having to take the trouble of switching manually.

- ◆ The selection of computers to be included for Auto Scanning is made with the *Scan/Skip* mode setting under the **F3 SET** function (see page 33).
- ◆ The amount of time that each port displays for is set with the *Scan Duration* setting under the **F3 SET** function (see page 32).
- ◆ As each computer is accessed, an **S** appears in front of the port ID display to indicate that it is being accessed under *Auto Scan* mode.
- ◆ While you are in Auto Scan mode, you can pause the scanning in order to keep the focus on a particular computer either by pressing **P**, or with a left click of the mouse. To resume scanning, press any key or left click again. See *Auto Scan Mode Switching*, page 44, for details.
- ◆ While Auto Scan mode is in effect, the console will not function normally. You must exit Auto Scan mode in order to regain control of the console.
- ◆ To exit Auto Scan mode, press the [Spacebar] or [Esc].

F8: LOUT

Clicking the **F8** field, or pressing [**F8**], logs you out of the OSD and blanks the console screen. This is different from simply deactivating the OSD when you are at the Main Screen by pressing [Esc].

With this function you must log in all over again to regain access to the OSD, whereas with [Esc], all you have to do to reenter the OSD is tap the OSD Hotkey.

-
- Note:**
1. When you reenter the OSD after logging out, the screen stays blank except for the login dialog box. You must input your username and password before you can continue (see page 27).
 2. If you reenter the OSD after logging out, and immediately use [Esc] to deactivate the OSD without having selected a port from the OSD menu, a Null Port message displays on the screen. The OSD hotkey will bring up the OSD Main Screen.
-

Hotkey Port Control

Hotkey port control allows you to provide KVM focus to a particular computer directly from the keyboard. The KH1508Ai / KH1516Ai provides the following Hotkey port control features:

- ◆ Selecting the Active Port
- ◆ Auto Scan Mode Switching
- ◆ Skip Mode Switching
- ◆ Computer Keyboard / Mouse Reset

The following settings can also be controlled in *Hotkey* mode:

- ◆ Setting the Beeper
- ◆ Setting the Quick Hotkey
- ◆ Setting the OSD Hotkey
- ◆ Setting the Port Operating System
- ◆ Restoring the OSD Default Values

Invoking Hotkey Mode

All Hotkey operations begin by invoking *Hotkey* mode.¹ To invoke *Hotkey* mode you may use two possible keystroke sequences shown below. Only one of the two key-sequences below can be operational (see *Setting the Hotkey key combination* on page 48):

Number Lock and Minus Keys

1. Hold down the **[Num Lock]** key;
2. Press and release the **[Minus]** key;
3. Release the **[Num Lock]** key:
[Num Lock] + [-]

Control and F12 Keys

1. Hold down the **[Ctrl]** key;
2. Press and release the **[F12]** key;
3. Release the **[Ctrl]** key:
[Ctrl] + [F12]

Hotkey Mode Environment

When *Hotkey* mode is active:

- ♦ A command line appears on the monitor screen. The command line prompt is the word *Hotkey:* in white text on a blue background, and displays the subsequent Hotkey information that you key in.
- ♦ Ordinary keyboard and mouse functions are suspended – only Hotkey compliant keystrokes (described in the sections that follow), can be input.

Exiting Hotkey Mode

Pressing **[Esc]** exits Hotkey mode.

1. Make sure that the *Hotkey Command Mode* function is enabled and that you key in the appropriate *Hotkey*. See page 33 for details.

Selecting the Active Port

Each computer port is assigned a port ID (see *Port ID Numbering*, page 26). You can directly access any computer with a Hotkey combination that specifies the port ID that the computer is connected to. The steps are:

1. Enter the Hotkey mode with the:

[Num Lock] + [-] or [Ctrl] + [F12] combination.

2. Key in the port ID.

The port ID numbers display on the command line as you key them in. If you make a mistake, use **[Backspace]** to erase it.

3. Press **[Enter]**.

After you press **[Enter]**, the KVM focus switches to the designated computer and you automatically exit Hotkey mode.

Note: In Hotkey mode, the KVM focus will not switch to a port if an invalid switch or port number is entered. The Hotkey command line will continue to display on the screen until you enter a valid switch and port number combination, or exit Hotkey mode.

Auto Scan Mode Switching

Auto Scan automatically switches among all the active computer ports that are accessible to the currently logged on user at regular intervals. This allows their activity to be monitored automatically (See *SCAN/SKIP MODE* of the OSD F3 SET function, page 33).

Setting the Scan Interval

The amount of time Auto Scan keeps the focus on each port is set with the *SCANDURATION* setting of the OSD **F3 SET** function (see page 32). You can change the scan interval, before you activate Hotkey Auto Scanning, by entering the following Hotkey combination:

1. Enter the Hotkey mode:

[Num Lock] + [-] or [Ctrl] + [F12] combination.

2. Key in **[A] [n]**

Where **[A]** is the letter **A**, and **[n]** is a number from 1–255 that represents the length of the focus time in seconds.

The letter **A** and the numbers display on the command line as you key them in. Use **[Backspace]** to erase any wrong entry.

3. Press **[Enter]**

After you press **[Enter]**, you exit Hotkey mode, and are ready to start Auto Scanning.

Entering Auto Scan

To enter the Auto Scanning mode, key in the following Hotkey combination:

1. Enter the Hotkey mode:

[Num Lock] + [-] or [Ctrl] + [F12] combination.

2. Press **[A] + [Enter]**.

- ♦ While you are in Auto Scan mode, you can pause the scanning to keep the focus on a particular computer by pressing **[P]**. When Auto Scanning is paused, the Command Line displays: **Auto Scan: Paused.**

(Continues on next page.)

(Continued from previous page.)

When you want to keep the focus on a particular computer, *Pausing* is more convenient than exiting Auto Scan mode. When you resume scanning it starts at the computer where you paused. If you exited and then restarted Auto Scanning, it starts, at the beginning, from the first computer on the installation.

To resume Auto Scanning, press any key. Scanning continues from the computer you paused at.

- ◆ While the Auto Scan mode is operating, ordinary keyboard and mouse functions are suspended - only Auto Scan mode compliant keystrokes can be input. You must exit Auto Scan mode to regain normal control of the console.

Exiting Auto Scan

1. To exit Auto Scan mode press **[Esc]** or **[Spacebar]**. Auto Scanning stops when you exit Auto Scan mode.

Skip Mode Switching

This feature allows you to switch between computers in order to monitor them manually. You can focus on a particular port for as long as you like – as opposed to auto-scanning, which automatically switches the port focus after a fixed interval.

Entering Skip Mode

To enter *Skip* mode, key in the following Hotkey combination:

1. Enter the Hotkey mode by pressing the:
 [Num Lock] + [-] or **[Ctrl] + [F12]** combination.
2. Press one of the **[Arrow]** keys.

After you press one of the keyboard arrows, you automatically exit Hotkey mode and enter *Skip* mode where you can switch ports as follows:

←	Skips to the first accessible port. (See <i>SCAN/SKIP MODE</i> , page 33, for information regarding accessible ports.)
→	Skips to the next accessible port.
↑	Skips to the last accessible port of the previous station.
↓	Skips to the first accessible port of the next station.

Once you are in *Skip* mode, you can continue skipping by pressing the arrow keys. You do not have to use the **[Num Lock] + [-]** combination again.

While *Skip* mode is in effect, ordinary keyboard and mouse functions are suspended – only *Skip* mode compliant keystrokes can be input. You must exit *Skip* mode to regain normal control of the console.

Exiting Skip Mode

1. To exit *Skip* mode, press **[Esc]** or **[Spacebar]**.

Computer Keyboard / Mouse Reset

If either the keyboard or mouse stop functioning on the computer connected to the currently selected port, you can perform a keyboard / mouse reset on the computer by executing the following steps:

1. Enter the Hotkey mode with the:

[Num Lock] + [-] or [Ctrl] + [F12] combination.

2. Press **[F5]**.

After you press **[F5]** you automatically exit *Hotkey* mode and regain keyboard and mouse control on the computer connected to the KVM port. If you fail to regain keyboard / mouse control on the computer after pressing **[F5]**, perform a system reset. For more information see *reset button*, page 9.

This function is essentially the same as unplugging and replugging the keyboard and mouse on the target computer.

Setting the Hotkey Beeper ON/OFF

The beeper (see Activate Beeper, page 33) can be turned on and off with Hotkeys by the following steps:

1. Enter the Hotkey mode with the:

[Num Lock] + [-] or [Ctrl] + [F12] combination.

2. Press **[B]**.

After you press **[B]**, the beeper turns on or off. The command line displays *Beeper On* or *Beeper Off* for one second; then the message disappears and you automatically exit Hotkey mode.

Setting the Hotkey key combination

The keys used to enter the *Hotkey Mode* (see *HOTKEY COMMAND MODE*, page 33) can be switched between:

[Num Lock] + [-], and **[Ctrl] + [F12]**

by the following steps:

1. Enter the Hotkey mode with the:

[Num Lock] + [-] or **[Ctrl] + [F12]** combination.

2. Press **[H]**.

After you press **[H]**, the command line displays *HOTKEY HAS BEEN CHANGED* for one second; then the message disappears and you automatically exit *Hotkey* mode.

Setting the OSD Hotkey combination

The *Hotkeys* used to access the *OSD* (see *OSD HOTKEY*, page 32) can be switched between **[Scroll Lock]**, **[Scroll Lock]**, **[Ctrl]**, **[Ctrl]**, and **[Alt]**, **[Alt]** by the following steps:

1. Enter the Hotkey mode with the:

[Num Lock] + [-] or **[Ctrl] + [F12]** combination.

2. Press **[T]**.

After you press **[T]**, the command line displays *HOTKEY HAS BEEN CHANGED* for one second; then the message disappears and you automatically exit *Hotkey* mode.

Setting the Port Operating System

A port's operating system configuration can be matched to that of the computer attached to the port by performing the following steps:

1. Enter the Hotkey mode with the:
[Num Lock] + [-] or [Ctrl] + [F12] combination.
2. Press a **[Function]** key, where **[Function]** refers to one of the function keys in the following table:

Key	Description
F1	Sets the Port OS to Windows
F2	Sets the Port OS to Mac
F3	Sets the Port OS to Sun

After pressing a function key you automatically exit *Hotkey* mode.

Restore the Default Values

This administrator-only Hotkey restores the KH1508Ai / KH1516Ai default values (see *RESTORE DEFAULT VALUES* on page 35) by performing the following steps:

1. Enter the Hotkey mode with the:
[Num Lock] + [-] or [Ctrl] + [F12] combination.
2. Press **[R]**.
3. Press **[Enter]**.

After you press **[Enter]**, the command line displays *RESET TO DEFAULT SETTING* for three seconds; then the message disappears and you automatically exit *Hotkey* mode.

Hotkey Summary Table

[Num Lock] + [-] or [Ctrl] + [F12]	[A] [Enter]	Invokes <i>Auto Scan</i> mode. When <i>Auto Scan</i> mode is in effect, [P] or left-click pauses auto-scanning. When auto-scanning is paused, pressing any key or another left-click resumes auto-scanning.
	[B]	Toggles the Beeper On or Off.
	[Esc] or [Spacebar]	Exits hotkey mode.
	[F1]	Sets Operating System to Windows
	[F2]	Sets Operating System to Mac
	[F3]	Sets Operating System to Sun
	[H]	Toggles the Hotkey invocation keys.
	[Port ID] [Enter]	Switches access to the computer that corresponds to that Port ID.
	[R] [Enter]	Administrator only hotkey. It returns the switch's settings to their default values.
	[T]	Toggles the <i>OSD Hotkey</i> between [Ctrl] [Ctrl] and [Scroll Lock] [Scroll Lock].
	[←]	Invokes Skip Mode and skips from the current port to the first accessible port previous to it.
	[→]	Invokes Skip Mode and skips from the current port to the next accessible port.
	[↑]	Invokes Skip Mode and skips from the current port to the last accessible port of the previous Station.
	[↓]	Invokes Skip Mode and skips from the current port to the first accessible port of the next Station.

Chapter 5

Logging In

Overview

The KH1508Ai / KH1516Ai can be accessed via its Graphical User Interface (GUI) locally from a Laptop application (AP) program; and remotely from an internet browser; a Windows application (AP) program; and a Java application (AP) program.

No matter which access method you choose, the KH1508Ai / KH1516Ai switch's authentication procedure requires you to submit a valid username and password. If you supply invalid login information, the authentication routine will return an *Invalid Username or Password*, or *Login Failed* message. If you see this type of message, log in again with a correct username and password.

Note: If the number of invalid login attempts exceeds a specified amount, a timeout period is invoked. You must wait until the timeout period expires before you can attempt to log in again. See *Login Failures*, page 124 for further details.

Laptop USB Console Login

The KH1508Ai / KH1516Ai can be accessed via a laptop USB console application (AP) program at the local site. This AP is built into the KH1508Ai / KH1516Ai's firmware and does not require a download. To access the switch, do the following:

1. Use the Laptop USB Console cable included in the package to connect your laptop to the KH1508Ai / KH1516Ai's mini USB port, located on the unit's front panel (see *Single Station Installation*, page 16).
2. The KH1508Ai / KH1516Ai appears as a virtual drive in the laptop's file system. Locate the Laptop AP on the virtual CD ROM and double-click the ALTUSEN icon. The login screen appears:

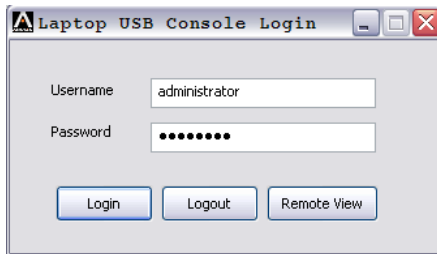

3. At the login screen, key in your valid Username and Password, then click **Login**. Once you have logged in successfully, the *Remote View* button becomes active:

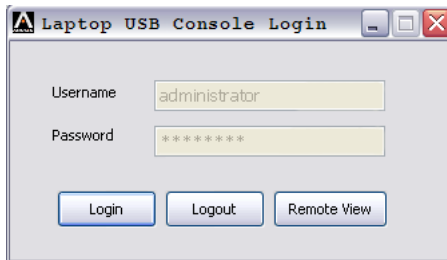

4. Click **Remote View** to bring up the Laptop USB Console Main Page. The Laptop USB Console Main Page is similar to the Web Browser, WinClient and Java Client Main Pages. For a description, see page 64.

Browser Login

The KH1508Ai / KH1516Ai can be accessed via an Internet browser running on any platform. To access the switch, do the following:

1. Open the browser and specify the IP address of the switch you want to access in the browser's location bar.

Note: 1. For security purposes, a login string may have been set by the administrator (see page 125 for details). If so, you must include a forward slash and the login string along with the IP address when you log in. For example:

192.168.0.100/kh1516ai

2. If you don't know the IP address and login string, ask your Administrator. The KH1508Ai / KH1516Ai's default IP address is: 192.168.0.60
-

2. When a Security *Alert* dialog box appears, accept the certificate – it can be trusted. (See *Trusted Certificates*, page 183, for details.) If a second certificate appears, accept it as well.

Once you accept the certificate(s), the login page appears:

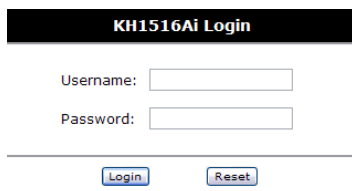

KH1516Ai Login

Username:

Password:

3. Provide your username and password (set by the administrator), then click **Login** to bring up the Web Main Page. For a discussion of the Web Main Page, see page 61.

Windows Client AP Login

The Windows AP Client allows direct remote access to Windows systems users, without having to go through a browser (although you initially download the Windows AP Client program from the browser page – see Chapter 12, *Download*). To connect to the KH1508Ai / KH1516Ai, go to the location on your hard disk that you downloaded the Windows AP Client program to, and double-click its icon (*WinClient.exe*). If this is the first time that you are running the utility, a dialog box appears requesting that you input your serial number:

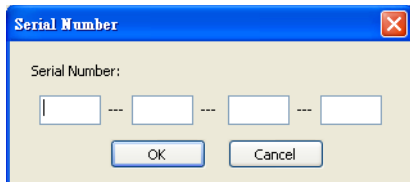

The serial number can be found on a sticker on the inside cover of the User Manual. Key in the serial number – 5 characters per box – then click OK to bring up the Windows Client Connection screen, shown below.

- Note:**
1. Letters in the serial number must be entered in upper case.
 2. This dialog box only appears the first time you run the program. In the future, you go directly to the Windows Client Connection screen.

Alternatively, upgrade the KH1508Ai / KH1516Ai to firmware v1.6.154 or later. The serial number will no longer be required for running the utility using this firmware version.

To connect to the KH1508Ai / KH1516Ai, click the *WinClient.exe* program icon (on your desktop) to bring up the Windows Client Connection screen:

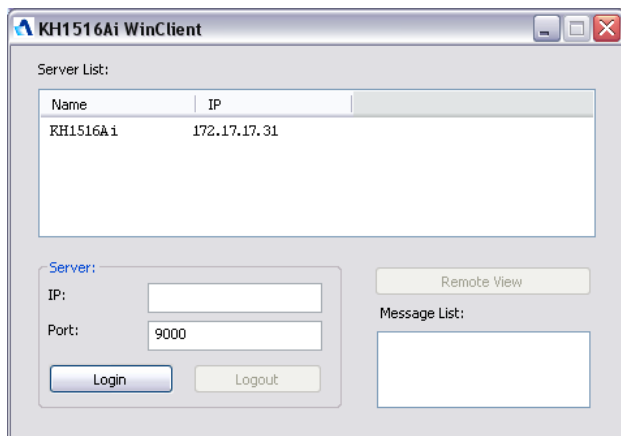

The Windows Client AP Connection Screen

A description of the Connection Screen is given in the following table:

Item	Description
Server List	<p>Each time the WinClient.exe file is run, it searches the user's local LAN segment for KH1508Ai / KH1516Ai, and lists whichever ones it finds in this box. If you want to connect to one of these units, double-click it. (See <i>Connecting – Windows Client AP</i>, page 56 for details.)</p> <p>Note: 1. The switch will not appear in the list unless its <i>Enable Device List</i> configuration parameter has been enabled.</p> <p>2. Only units whose Access Port settings for <i>Program</i> match the number specified for <i>Port</i> in the Server area of this dialog box appear in the Server List window.</p>
Server	<p>This area is used when you want to connect to a KH1508Ai / KH1516Ai at a remote location. You can drop down the IP list box and select an address from the list. If the address you want isn't listed, you can key in the target IP address in the IP field, and its port number in the Port field. (If you don't know the port number, contact your Administrator.)</p> <ul style="list-style-type: none"> ◆ When the IP address and Port number have been specified, click Connect. (See <i>Connecting – Windows Client AP</i>, page 56 for details.) ◆ When you have finished with your session and come back to this dialog box, click Disconnect to end the connection.
Message List	<p>Located just to the right of the Server panel, the Message List panel lists status messages regarding the connection to the KH1508Ai / KH1516Ai.</p>
Switch to Remote View	<p>Once you have been authenticated (see <i>Connecting – Windows Client AP</i>, page 56 for details), this button becomes active. Click it to switch to the GUI Main Page. The GUI Main Page is described on page 61.</p>

Connecting – Windows Client AP

To connect to a KVM Over the NET™ switch do the following::

1. From the *Server List* box, **double-click** the device that you wish to connect to.
– Or –
Specify its IP address and port number in the *Server IP* and *Port* input boxes.
2. Click **Connect**.
The *Login* dialog box appears:

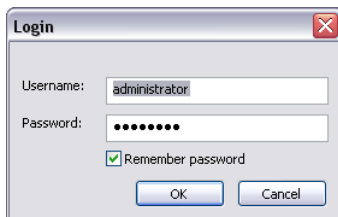

3. Key in a valid Username and Password, and then click **OK**.
4. Once you have been authenticated, the *Remote View* button becomes active:

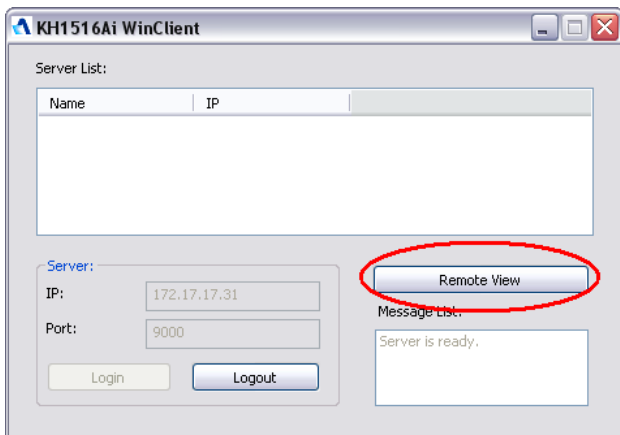

5. Click it to connect to the switch and bring up its GUI Main Page. For a description of the GUI Main Page, see page 61.

Java Client AP Login

The Java AP Client provides direct remote access to non-Windows systems users (although you initially download the Java AP Client program from the browser page – see Chapter 12, *Download*). To connect to the KH1508Ai / KH1516Ai, go to the location on your hard disk that you downloaded the Java AP Client program to, and double-click its icon (*JavaClient.jar*). If this is the first time that you are running the utility, a dialog box appears requesting that you input your serial number:

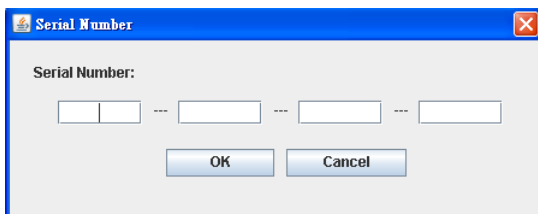

The serial number can be found on a sticker on the inside cover of the User Manual. Key in the serial number – 5 characters per box – then click OK to bring up the Windows Client Connection screen, shown below.

- Note:**
1. Letters in the serial number must be entered in upper case.
 2. This dialog box only appears the first time you run the program. In the future, you go directly to the Java Client Connection screen.

Alternatively, upgrade the KH1508Ai / KH1516Ai to firmware v1.6.154 or later. The serial number will no longer be required for running the utility using this firmware version.

To connect to the KH1508Ai / KH1516Ai, click the *JavaClient.jar* program icon (on your desktop) to bring up the Windows Client Connection screen:

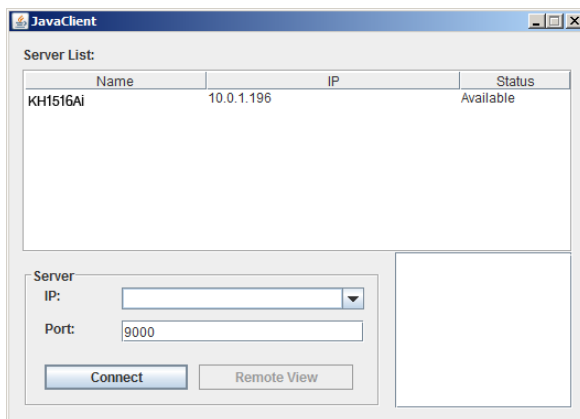

The Java Client AP Connection Screen

A description of the Connection Screen is given in the following table:

Item	Description
Server List	<p>Each time the JavaClient.jar file is run, it searches the User's local LAN segment for KH1508Ai / KH1516Ai, and lists whichever ones it finds in this box. If you want to connect to one of these units, double-click it. (See <i>Connecting – Windows Client AP</i>, page 56 for details.)</p> <p>Note:</p> <ol style="list-style-type: none"> 1. The switch will not appear in the list unless its <i>Enable Device List</i> configuration parameter has been enabled. 2. Only units whose Access Port settings for <i>Program</i> (see <i>Service Ports</i>, page 116) match the number specified for <i>Port</i> in the Server area of this dialog box appear in the Server List window.
Server	<p>This area is used when you want to connect to a KH1508Ai / KH1516Ai at a remote location. You can drop down the IP list box and select an address from the list. If the address you want isn't listed, you can key in the target IP address in the IP field, and its port number in the Port field. (If you don't know the port number, contact your Administrator.)</p> <ul style="list-style-type: none"> ◆ When the IP address and Port number have been specified, click Connect. (See <i>Connecting – Windows Client AP</i>, page 56 for details.) ◆ When you have finished with your session and come back to this dialog box, click Disconnect to end the connection.
Message Panel	<p>Located just to the right of the Server panel, the Message panel lists status messages regarding the connection to the KH1508Ai / KH1516Ai.</p>
Switch to Remote View	<p>Once you have been authenticated (see <i>Connecting – Windows Client AP</i>, page 56 for details), this button becomes active. Click it to switch to the GUI Main Page. The GUI Main Page is described on page 61.</p>

Connecting – Java Client AP

To connect to a KVM Over the NET™ switch do the following:

1. From the *Server List* box, **double-click** the device that you wish to connect to.

– Or –

Specify its IP address and port number in the *Server IP* and *Port* input boxes.

2. Click **Login**

The *Login* dialog box appears:

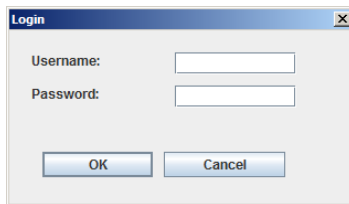

3. Key in a valid Username and Password, and then click **OK**.
4. Once you have been authenticated, the *Remote View* button becomes active:

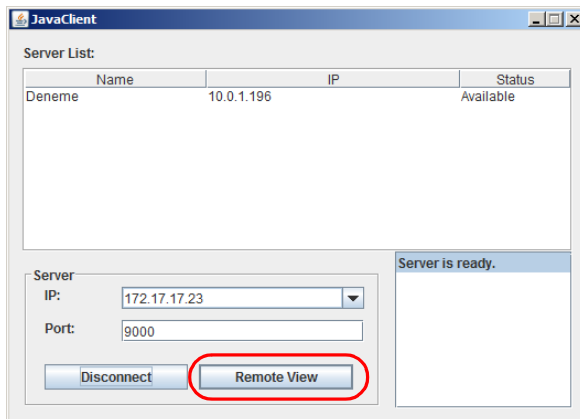

5. Click it to connect to the switch and bring up its GUI Main Page. For a description of the GUI Main Page, see page 61.

This Page Intentionally Left Blank

Chapter 6

The User Interface

Overview

Once you have successfully logged in, the KH1508Ai / KH1516Ai user interface Main Page appears. The look of the page varies slightly, depending on which method you used to log in. Each of the interfaces is described in the sections that follow.

The Web Browser Main Page

To ensure multi-platform operability, access to the KH1508Ai / KH1516Ai can be accomplished with most standard web browsers. Once users log in and are authenticated (see page 51), the *Web Browser Main Page* comes up, with the Port Access page displayed:

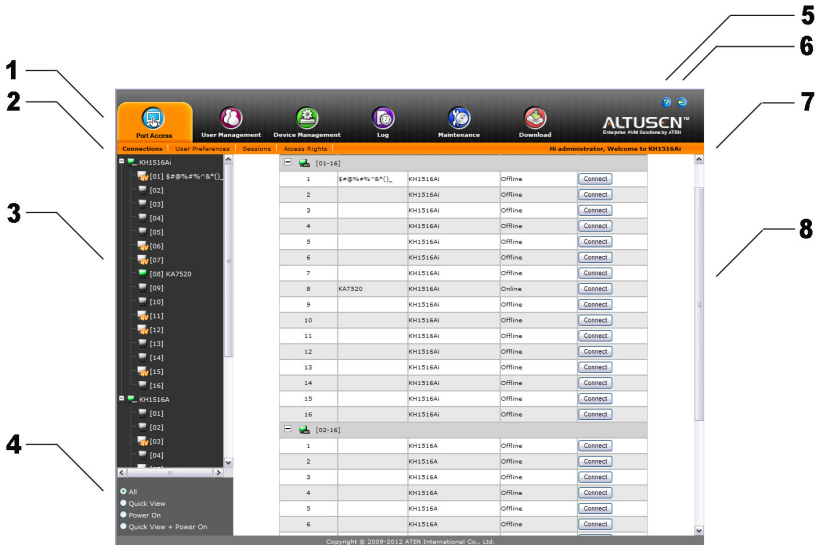

Note: The screen depicts an Administrator's page. Depending on a user's type and permissions, not all of these elements appear.







Page Components

The web page screen components are described in the table, below:



No.	Item	Description
1	Tab Bar	The tab bar contains the KH1508Ai / KH1516Ai main operation categories. The items that appear in the tab bar are determined by the user's type, and the authorization options that were selected when the user's account was created.
2	Menu Bar	The menu bar contains operational sub-categories that pertain to the item selected in the tab bar. The items that appear in the menu bar are determined by the user's type, and the authorization options that were selected when the user's account was created.
3	Sidebar	The Sidebar provides a tree view listing of ports that relate to the various tab bar and menu bar selections. Clicking a node in the Sidebar brings up a page with the details that are relevant to it.
4	Filter	<p>The filter section at the bottom of the Sidebar lets you expand or narrow the scope of the ports that appear in the Sidebar tree, as follows:</p> <ul style="list-style-type: none"> ◆ <i>All</i> – Lists all of the ports on the installation ◆ <i>Quick View</i> – Lists only the ports that have been selected as Quick View ports ◆ <i>Power On</i> – Lists only the ports that have their attached devices powered on ◆ <i>Quick View + Power On</i> – Lists only that ports that have been selected as Quick View ports and that have their attached devices turned on.
5	Help	About provides information regarding the switch's current firmware version.
6	Logout	Click this button to log out of your KH1508Ai / KH1516Ai session.
7	Welcome Message	If this function is enabled (see <i>Welcome Message*</i> , page 100), a welcome message displays here.
8	Interactive Display Panel	This is your main work area. The screens that appear reflect your menu choices and Sidebar node selection.

The Tab Bar

The number and type of icons that appear on the Tab Bar at the top of the page are determined by the user's type (Administrator or User) and the permissions assigned when the user's account was created. The functions associated with each of the icons are explained in the table below:

Icon	Function
	Port Access: The Port Access page is used to access and control the devices on the KH1508Ai / KH1516Ai installation. This page is available to all users.
	User Management: The User Management page is used to create and manage Users and Groups. It can also be used to assign devices to them. User Management is discussed on page 105. This tab is available to the Administrator, as well as users who have been given User Management permission. The tab doesn't appear for other users.
	Device Management: The Device Management page is used to configure and control the overall operation of the KH1508Ai / KH1516Ai. This page is available to the Administrator, as well as users who have been given Device Management permission. The tab doesn't appear for other and users.
	Log: The Log page displays the contents of the log file. The Log page is discussed on page 135.
	Maintenance: The Maintenance page is used to install new firmware; backup and restore configuration and account information; ping network devices; and restore default values. The Maintenance page is discussed on page 137. This page is available to the Administrator and Users with <i>Maintenance</i> permission. The icon doesn't display on the page of ordinary users.
	Download: Users can click this icon to download AP versions of the Windows Client; the Java Client; and the Log Server. This page is available to all users. The programs that can be downloaded depend on the user's permissions.

There are two small icons at the extreme right of the page. Their functions are described in the table, below:

Icon	Function
	Click this icon to brings up a panel with information about the KVM Over the NET™ switch firmware version.
	Click this icon to log out and end your KVM Over the NET™ switch session.

Laptop USB Console Main Page

After connecting a laptop to the KH1508Ai / KH1516Ai's Laptop port, logging in, and opening the AP, the Laptop USB Console main page appears:

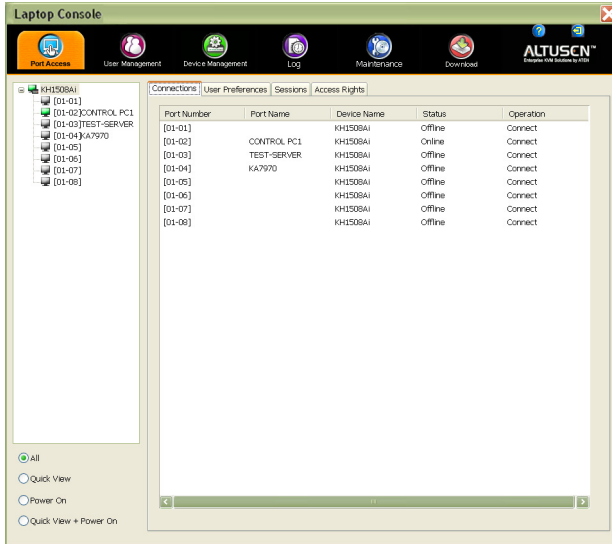

The look of the Laptop USB Console main page is the same as the AP GUI. See *The AP GUI Main Page*, page 65, for further details, and reference the AP GUI sections throughout the rest of the manual regarding operations.

The AP GUI Main Page

With WinClient AP, and Java Client AP access, once users log in (see *Logging In*, page 51), the *GUI Main Page* comes up:

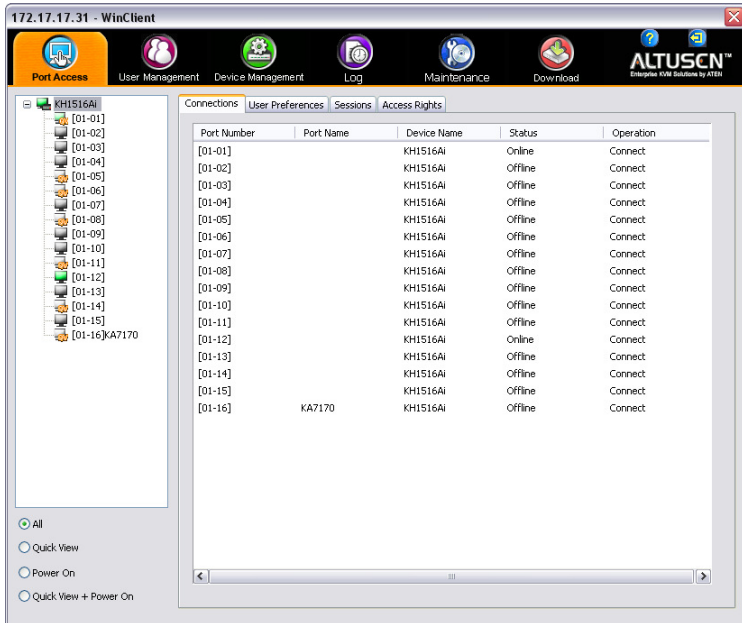

The GUI Main Page is similar to that of the Web Browser. The differences between them are as follows:

1. The AP GUI version doesn't have a menu bar below the tab bar; it has a series of tabs like a notebook, instead. Like the Web Browser interface, however, the makeup of the tabbed notebook changes depending on the items selected on the main Tab Bar and in the Sidebar.
2. There is a hidden *Control Panel* at the upper or lower center of the screen that becomes visible when you mouse over it. (The default is at the upper center of the screen.)

The Control Panel

WinClient Control Panel

Since the WinClient Control Panel contains the most complete functionality, this section describes the WinClient Control Panel. Although the Java Control Panel does not enable all of the features that this one does, the functions that they do share are the same, and you can refer to the information described here when using it.

The Control Panel is hidden at the upper or lower center of the screen (the default is at the lower center), and becomes visible when you mouse over it. The panel consists of three rows: an icon row at the top, and two text rows below it:

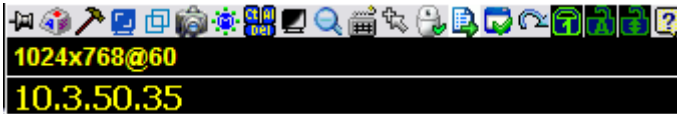

Note: The above image shows the complete Control Panel. The icons that appear can be user selected. See *Control Panel Configuration*, page 90, for details.

- ♦ By default, the upper text row shows the video resolution of the remote display. As the mouse pointer moves over the icons in the icon bar, however, the information in the upper text row changes to describe the icon's function. In addition, if a message from another user is entered in the message board, and you have not opened the message board in your session, the message will appear in the upper row.
- ♦ The lower row shows the IP address of the device you are accessing at the left of the row.



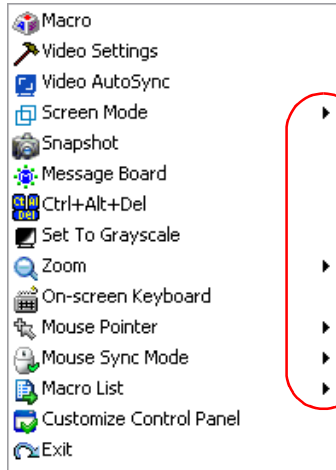









- ◆ Right clicking in the text row area brings up a menu-style version of the toolbar. In addition, it allows you to select options for the *Screen Mode*, *Zoom*, *Mouse Pointer* type, and *Mouse Sync Mode*. These functions are discussed in the sections that follow.







- ◆ To move the Control Panel to a different location on the screen, place the mouse pointer over the text row area, then click and drag.

WinClient Control Panel Functions

The Control Panel functions are described in the table below.

Icon	Function
	This is a toggle. Click to make the Control Panel persistent – i.e., it always displays on top of other screen elements. Click again to have it display normally.
	Click to bring up the Macros dialog box (see page 70 for details).
	Click to bring up the Video Options dialog box. Right-click to perform a quick Auto Sync (see <i>Video Settings</i> , page 79, for details).
	Click to perform a video and mouse autosync operation. It is the same as clicking the Auto-sync button in the <i>Video Options</i> dialog box (see <i>Video Settings</i> , page 79).
	Toggles the display between <i>Full Screen Mode</i> and <i>Windowed Mode</i> .
	Click to take a snapshot (screen capture) of the remote display. See <i>Snapshot</i> , page 91, for details on configuring the Snapshot parameters.
	Click to bring up the Message Board (see <i>The Message Board</i> , page 82).
	Click to send a Ctrl+Alt+Del signal to the remote system.
	Click to toggle the remote display between color and gray scale views.
	Click to zoom the remote display window. Note: This feature is only available in windowed mode (Full Screen Mode is off). See <i>Zoom</i> , page 84 for details.
	Click to bring up the on-screen keyboard (see <i>The On-Screen Keyboard</i> , page 85).
	Click to select the mouse pointer type. Note: This icon changes depending on which mouse pointer type is selected (see <i>Mouse Pointer Type</i> , page 87).

	<p>Click to toggle Automatic or Manual mouse sync.</p> <ul style="list-style-type: none"> ◆ When the selection is <i>Automatic</i>, a green √ appears on the icon. ◆ When the selection is <i>Manual</i>, a red X appears on the icon. <p>See <i>Mouse DynaSync Mode</i>, page 88 for a complete explanation of this feature.</p>
	<p>Click to display a dropdown list of <i>User</i> macros in order to access and run macros more conveniently than using the Macros dialog box (see the <i>Macros</i> icon in the table above, and the <i>Macros</i> section on page 70).</p>
	<p>Click to bring up the Control Panel Configuration dialog box. See <i>Control Panel Configuration</i>, page 90, for details on configuring the Control Panel.</p>
	<p>Click to exit the viewer.</p> <ul style="list-style-type: none"> ◆ Exiting from a Browser Viewer session brings you back to the web browser Main Page. ◆ Exiting from a WinClient AP session brings you back to the login dialog box (see page 54). ◆ Exiting from a Java Client AP session brings you back to the login dialog box (see page 57).
	<p>These icons show the Num Lock, Caps Lock, and Scroll Lock status of the remote computer.</p> <ul style="list-style-type: none"> ◆ When the lock state is <i>On</i>, the LED is bright green and the lock hasp is closed. ◆ When the lock state is <i>Off</i>, the LED is dull green and the lock hasp is open. <p>Click on the icon to toggle the status.</p> <p>Note: These icons and your local keyboard icons are in sync. Clicking an icon causes the corresponding LED on your keyboard to change accordingly. Likewise, pressing a Lock key on your keyboard causes the icon's color to change accordingly.</p>



Macros

The Macros icon provides access to three functions found in the Macros dialog box: Hotkeys, User Macros, and System Macros. Each of these functions is described in the following sections.

Hotkeys

Various actions related to manipulating the remote server can be accomplished with hotkeys. The *Hotkey Setup* utility (accessed by clicking this icon), lets you configure which hotkeys perform the actions.

The hotkeys that invoke an action are shown to the right of its name. Use the checkbox to the left of an action's name to enable or disable its hotkey.

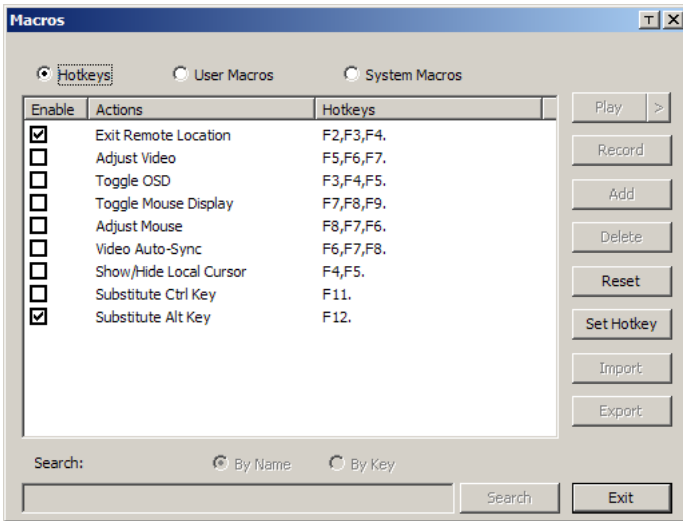

To change the hotkey for an action, do the following:

1. Highlight the *Action*, then click **Set Hotkey**.
2. Press your selected Function keys (one at a time). The key names appear in the *Hotkeys* field as you press them.
 - ◆ You can use the same function keys for more than one action, as long as the key sequence is not the same.
 - ◆ To cancel setting a hotkey value, click **Cancel**; to clear an action's Hotkeys field, click **Clear**.
3. When you have finished keying in your sequence, click **Save**.

To reset all the hotkeys to their default values, click **Reset**.

An explanation of the Hotkey actions is given in the table below:

Action	Explanation
Exit Remote Location	Breaks the connection to the KH1508Ai / KH1516Ai and returns you to local client computer operation. This is equivalent to clicking the <i>Exit</i> icon on the Control Panel. The default keys are F2, F3, F4.
Adjust Video	Brings up the <i>Video Settings</i> dialog box. This is equivalent to clicking the <i>Video Settings</i> icon on the Control Panel. The default keys are F5, F6, F7.
Toggle OSD	Toggles the OSD Control Panel Off and On. The default keys are F3, F4, F5.
Toggle Mouse Display	<p>If you find the display of the two mouse pointers (local and remote) to be confusing or annoying, you can use this function to shrink the non-functioning pointer down to a barely noticeable tiny circle, which can be ignored. Since this function is a toggle, use the hotkeys again to bring the mouse display back to its original configuration. This is equivalent to selecting the <i>Single</i> pointer type from the <i>Mouse Pointer</i> icon on the Control Panel. The default keys are F7, F8, F9.</p> <p>Note: The Java Control Panel does not have this feature.</p>
Adjust Mouse	This synchronizes the local and remote mouse movements. The default keys are F6, F7, F8.
Video Autosync	This combination performs an auto-sync operation. It is equivalent to clicking the <i>Video Autosync</i> icon on the Control Panel. The default keys are F8, F7, F6.
Show/Hide Local Cursor	Toggles the display of your local mouse pointer off and on. This is equivalent to selecting the <i>Null</i> pointer type from the <i>Mouse Pointer</i> icon on the Control Panel. The default keys are F4,F5.
Substitute Ctrl key	If your local client computer captures Ctrl key combinations, preventing them from being sent to the remote server, you can implement their effects on the remote server by specifying a function key to substitute for the Ctrl key. If you substitute the F11 key, for example, pressing [F11 + 5] would appear to the remote server as [Ctrl + 5]. The default key is F11.
Substitute Alt key	Although all other keyboard input is captured and sent to the KH1508Ai / KH1516Ai switch, [Alt + Tab] and [Ctrl + Alt + Del] work on your local client computer. In order to implement their effects on the remote server, another key may be substituted for the Alt key. If you substitute the F12 key, for example, you would use [F12 + Tab] and [Ctrl + F12 + Del]. The default key is F12.

User Macros

User Macros are created to perform specific actions on the remote server. To create the macro, do the following:

1. Select *User Macros*, then click **Add**.

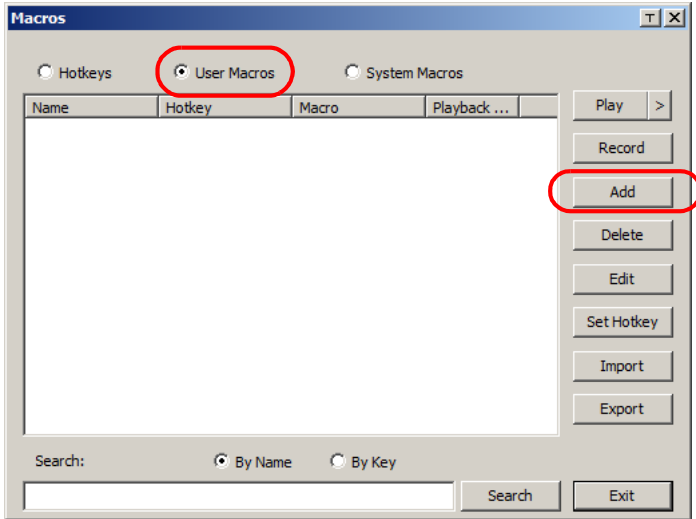

2. In the dialog box that comes up, replace the “New Macro” text with a name of your choice for the macro:

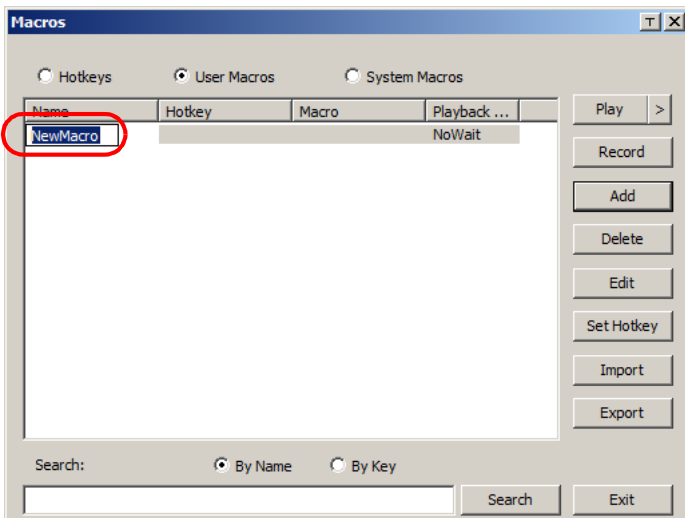

3. Click **Record**.

The dialog box disappears, and a small panel appears at the top left of the screen:



4. Press the keys for the macro.

- ◆ To pause macro recording, click **Pause**. To resume, click **Pause** again.
- ◆ Clicking **Show** brings up a dialog box that lists each keystroke that you make, together with the amount of time each one takes:

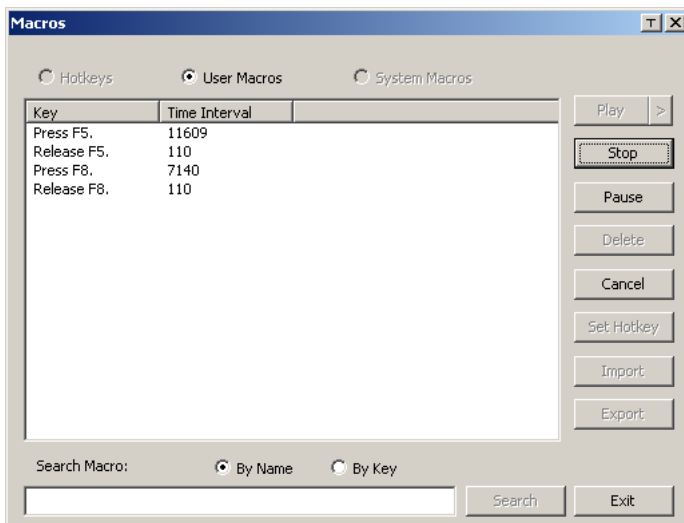

- ◆ Clicking **Cancel** cancels all keystrokes.
- ◆ When you have finished, click **Stop**. (This is the equivalent of clicking *Done* in Step 5.)

Note: 1. Case is not considered – typing **A** or **a** has the same effect.

2. When recording the macro the focus must be on the remote screen. It cannot be in the macro dialog box.
 3. Only the default keyboard characters may be used. Alternate characters cannot be used. For example, if the keyboard is Traditional Chinese and default character is **A** the alternate Chinese character obtained via keyboard switching is not recorded.
-

- If you haven't brought up the Show dialog, click **Done** when you have finished recording your macro. You return to the Macros dialog box with your macro key presses displayed in the Macro column:

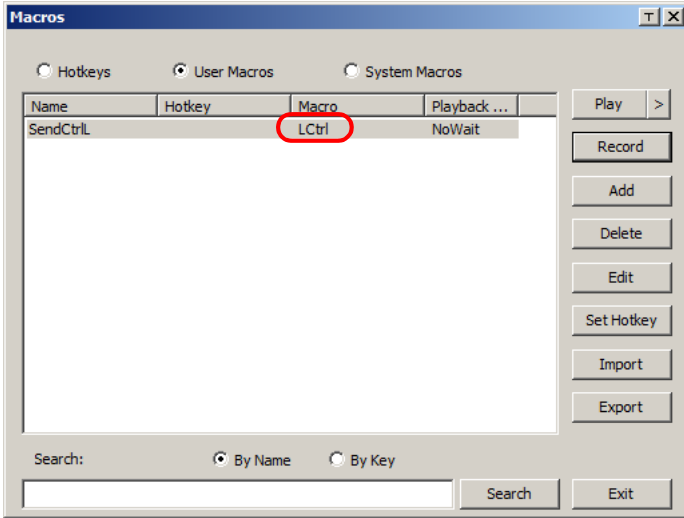

- If you want to change any of the keystrokes, select the macro and click **Edit**. This brings up a dialog box similar to the one for Show. You can change the content of your keystrokes, change their order, etc.
- Repeat the procedure for any other macros you wish to create.

After creating your macros, you can run them in any of three ways:

1. By using the hotkey (if one was assigned).
2. By opening the Macro List on the Control Panel and clicking the one you want (see page 69).
3. By opening this (Macros) dialog box and clicking **Play**.



If you run the macro from this dialog box, you have the option of specifying how the macro runs.

- ◆ If you choose *Play Without Wait*, the macro runs the keypresses one after another with no time delay between them.
- ◆ If you choose *Play With Time Control*, the macro waits for the amount of time between key presses that you took when you created it. Click on the arrow next to *Play* to make your choice.
- ◆ If you click *Play* without opening the list, the macro runs with the default choice (*NoWait* or *TimeCtrl*), which is shown in the *Playback* column.

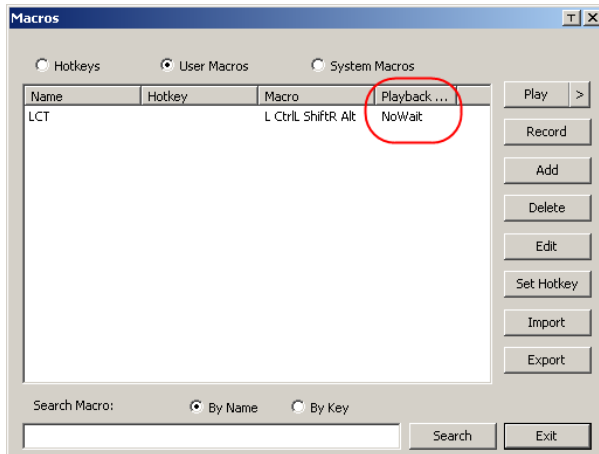

You can change the default choice by clicking on the current choice (*NoWait* in the screenshot above), and selecting the alternate choice.

Note: 1. Information about the Search function is given on page 76.

2. User Macros are stored on the Local Client computer of each user. Therefore, there is no limitation on the of number of macros, the size of the macro names, or makeup of the hotkey combinations that invoke them

■ Search

Search, at the bottom of the dialog box, lets you filter the list of macros that appear in the large upper panel for you to play or edit. Click a radio button to choose whether you want to search by name or by key; key in a string for the search; then click **Search**. All instances that match your search string appear in the upper panel.

System Macros

System Macros are used to create exit macros for when you close a session. For example, as an added measure of security, you could create a macro that sends the Winkey-L combination which would cause the remote server's log in page to come up the next time the device was accessed. To create the macro, do the following:

1. Select *System Macros*, then click **Add**.

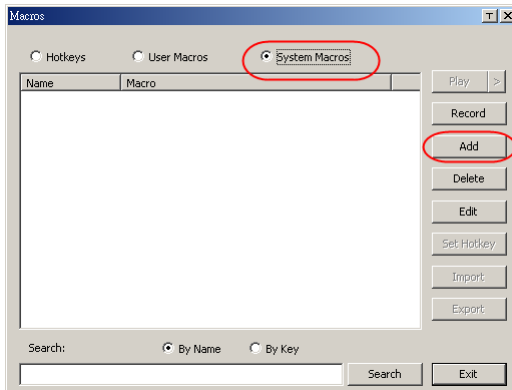

2. In the dialog box that comes up, replace the "New Macro" text with a name of your choice for the macro:

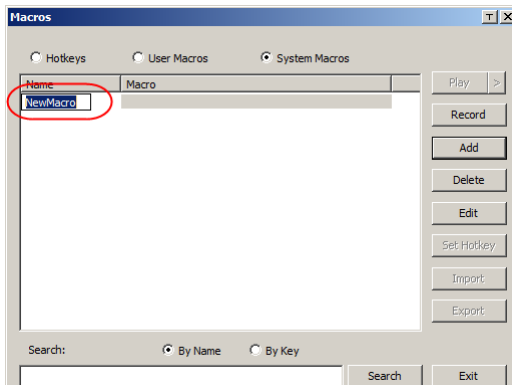

3. Click **Record**.

The dialog box disappears, and a small panel appears at the top left of the screen:

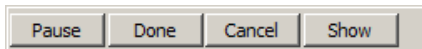

4. Press the keys for the macro.

- ◆ To pause macro recording, click **Pause**. To resume, click **Pause** again.
- ◆ Clicking **Show** brings up a dialog box that lists each keystroke that you make, together with the amount of time each one takes (see page 77).

Note: 1. Case is not considered – typing **A** or **a** has the same effect.

5. When recording the macro the focus must be on the remote screen. It cannot be in the macro dialog box.
2. Only the default keyboard characters may be used. Alternate characters cannot be used. For example, if the keyboard is Traditional Chinese and default character is **A** the alternate Chinese character obtained via keyboard switching is not recorded.

-
6. If you haven't brought up the Show dialog, click **Done** when you have finished recording your macro. You return to the Macros dialog box with your system macro key presses displayed in the Macro column:

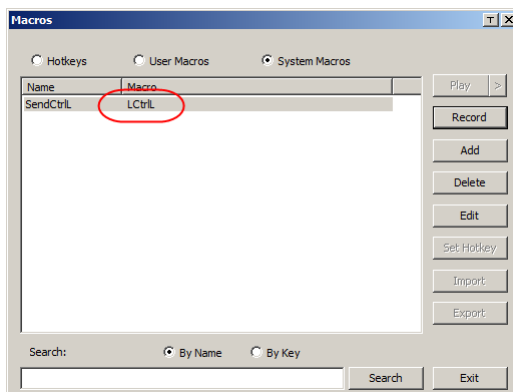

7. If you want to change any of the keystrokes, select the macro and click **Edit**. This brings up a dialog box similar to the one for Show. You can change the content of your keystrokes, change their order, etc.
8. Repeat the procedure for any other macros you wish to create.

Once the system macros have been created, they are available for use on a port-by-port basis. They get selected on a port's *Port Configuration* → *Port Properties* page (see *Port Level*, page 98 for details).

-
- Note:**
1. Information about the Search function is given on page 76.
 2. You can choose only one system macro per port.
 3. Systems macros are stored on the switch, therefore macro names may not exceed 64 Bytes; hotkey combinations may not exceed 256 Bytes. (Each key usually takes 3–5 Bytes.)
-



Video Settings

Clicking the *Hammer* icon on the Control Panel brings up the *Video Settings* dialog box. The options in this dialog box allow you to adjust the placement and picture quality of the remote screen on your monitor:

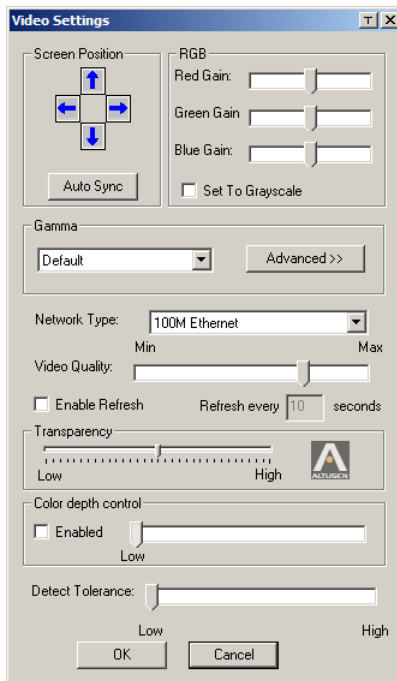

The meanings of the video adjustment options are given in the table below:

Options	Usage
Screen Position	Adjust the horizontal and vertical position of the remote server window by Clicking the Arrow buttons.
Auto-Sync	<p>Click Auto-Sync to have the vertical and horizontal offset values of the remote screen detected and automatically synchronized with the local screen.</p> <p>Note: 1. If the local and remote mouse pointers are out of sync, in most cases, performing this function will bring them back into sync.</p> <p>2. This function works best with a bright screen.</p> <p>3. If you are not satisfied with the results, use the Screen Position arrows to position the remote display manually.</p>

Options	Usage
RGB	<p>Drag the slider bars to adjust the RGB (Red, Green, Blue) values. When an RGB value is increased, the RGB component of the image is correspondingly increased.</p> <p>If you enable <i>Set to Grayscale</i>, the remote video display is changed to grayscale.</p>
Gamma	<p>This section allows you to adjust the video display's gamma level. This function is discussed in detail in the next section, <i>Gamma Adjustment</i>.</p>
Network Type	<p>Select the type of internet connection that the local client computer uses. The switch will use that selection to automatically adjust the <i>Video Quality</i> and <i>Detect Tolerance</i> settings to optimize the quality of the video display.</p> <p>Since network conditions vary, if none of the pre-set choices seem to work well, you can select <i>Customize</i> and use the <i>Video Quality</i> and <i>Detect Tolerance</i> slider bars to adjust the settings to suit your conditions.</p>
Video Quality	<p>Drag the slider bar to adjust the overall Video Quality. The larger the value, the clearer the picture and the more video data goes through the network. Depending on the network bandwidth, a high value may adversely effect response time.</p>
Enable Refresh	<p>The KH1508Ai / KH1516Ai can redraw the screen every 1 to 99 seconds, eliminating unwanted artifacts from the screen. Select Enable Refresh and enter a number from 1 through 99. The KH1508Ai / KH1516Ai will redraw the screen at the interval you specify. This feature is disabled by default. Click to put a check mark in the box next to <i>Enable Refresh</i> to enable this feature.</p> <p>Note:</p> <ol style="list-style-type: none"> 1. The switch starts counting the time interval when mouse movement stops. 2. Enabling this feature increases the volume of video data transmitted over the network. The lower the number specified, the more often the video data is transmitted. Setting too low a value may adversely affect overall operating responsiveness.
Transparency	<p>Adjusts the transparency of the toolbar that comes up when the GUI hotkey ([Scroll Lock][Scroll Lock], for example), is invoked. Slide the bar until the display in the example window is to your liking.</p>
Color Depth Control	<p>This setting determines the richness of the video display by adjusting the amount of color information.</p>
Detect Tolerance	<p>This setting also relates to video quality. It governs detecting or ignoring pixel changes. A high setting can result in a lower quality display due to less data transfer. A lower setting will result in better video quality, but setting the threshold too low may allow too much data to be transferred, negatively impacting network performance.</p>

Gamma Adjustment

If it is necessary to correct the gamma level for the remote video display, use the *Gamma* function of the Video Adjustment dialog box.

- ◆ Under *Basic* configuration, there are ten preset and four user-defined levels to choose from. Drop down the list box and choose the most suitable one.
- ◆ For greater control, clicking the *Advanced* button brings up the following dialog box:

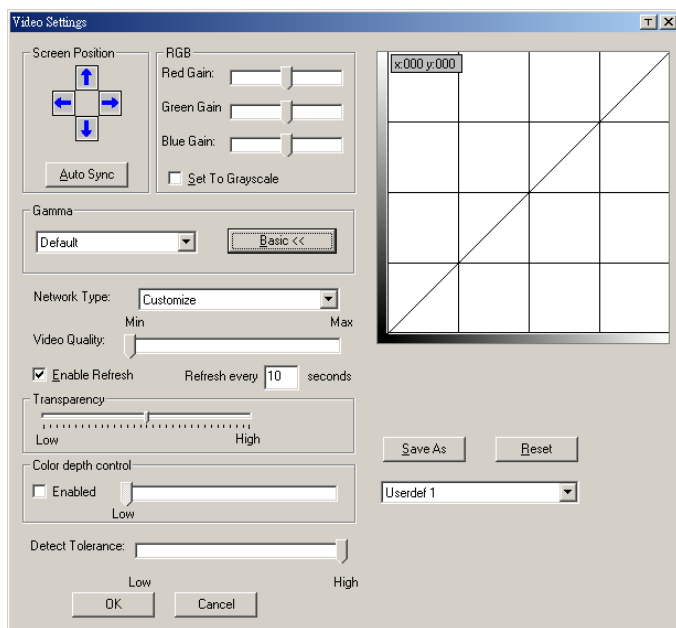

- ◆ Click and drag the diagonal line at as many points as you wish to achieve the display output you desire.
- ◆ Click **Save As** to save up to four user-defined configurations derived from this method. Saved configurations can be recalled from the list box at a future time.
- ◆ Click **Reset** to abandon any changes and return the gamma line to its original diagonal position.
- ◆ Click **OK** to save your changes and close the dialog box.
- ◆ Click **Cancel** to abandon your changes and close the dialog box.

Note: For best results, change the gamma while viewing a remote server.





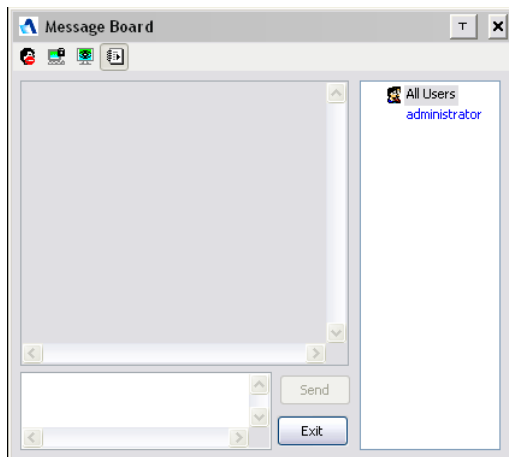

The Message Board

The KH1508Ai / KH1516Ai supports multiple user logins, which may cause access conflicts. To alleviate the problem, a message board has been provided, which allows users to communicate with each other:



Button Bar

The buttons on the Button Bar are toggles. Their actions are described in the table below:

Button	Action
	Enable/Disable Chat. When disabled, messages posted to the board are not displayed. The button is shadowed when Chat is disabled. The icon displays next to the user's name in the User List panel when the user has disabled Chat.
	Occupy/Release Keyboard/Video/Mouse. When you Occupy the KVM, other users cannot see the video, and cannot input keyboard or mouse data. The button is shadowed when the KVM is occupied. The icon displays next to the user's name in the User List panel when the user has occupied the KVM.
	Occupy/Release Keyboard/Mouse. When you Occupy the KM, other users can see the video, but cannot input keyboard or mouse data. The button is shadowed when the KM is occupied. The icon displays next to the user's name in the User List panel when the user has occupied the KM.
	Show/Hide User List. When you Hide the User List, the User List panel closes. The button is shadowed when the User List is open.

Message Display Panel

Messages that users post to the board - as well as system messages - display in this panel. If you disable Chat, however, messages that get posted to the board won't appear.

Compose Panel

Key in the messages that you want to post to the board in this panel. Click **Send**, or press [**Enter**] to post the message to the board.

User List Panel

The names of all the logged in users are listed in this panel.

- ◆ Your name appears in blue; other users' names appear in black.
- ◆ By default, messages are posted to all users. To post a message to one individual user, select the user's name before sending your message.
- ◆ If a user's name is selected, and you want to post a message to all users, select All Users before sending your message.
- ◆ If a user has disabled Chat, its icon displays before the user's name to indicate so.
- ◆ If a user has occupied the KVM or the KM, its icon displays before the user's name to indicate so.

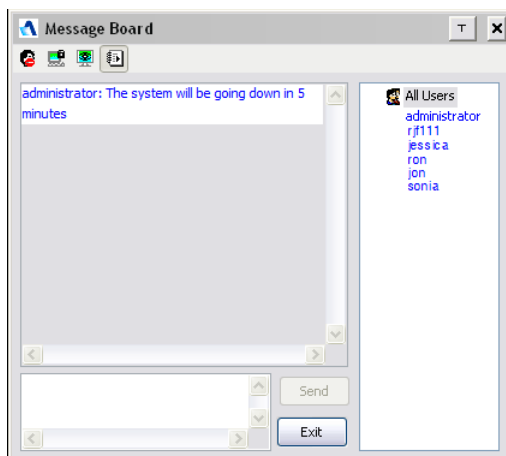



Zoom

The Zoom icon controls the zoom factor for the remote view window. Settings are as follows:

Setting	Description
100%	Sizes and displays the remote view window at 100%.
75%	Sizes and displays the remote view window at 75%.
50%	Sizes and displays the remote view window at 50%.
25%	Sizes and displays the remote view window at 25%.
1:1	Sizes and displays the remote view window at 100%. The difference between this setting and the 100% setting is that when the remote view window is resized its contents don't resize – they remain at the size they were. To see any objects that are outside of the viewing area move the mouse to the window edge, to have the screen scroll.



The On-Screen Keyboard

The KVM Over the NET™ switch supports an on-screen keyboard, available in multiple languages, with all the standard keys for each supported language. Click this icon to pop up the on-screen keyboard:

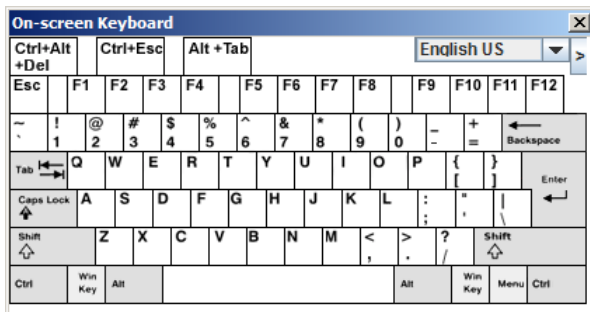

One of the major advantages of the on-screen keyboard is that if the keyboard languages of the remote and local systems aren't the same, you don't have to change the configuration settings for either system. Just bring up the on-screen keyboard; select the language used by the server you are accessing; and use the on-screen keyboard to communicate with it.

Note: You must use your mouse to click on the keys. You cannot use your actual keyboard.

Changing Languages

To change languages, do the following:

1. Click the down arrow next to the currently selected language, to drop down the language list.

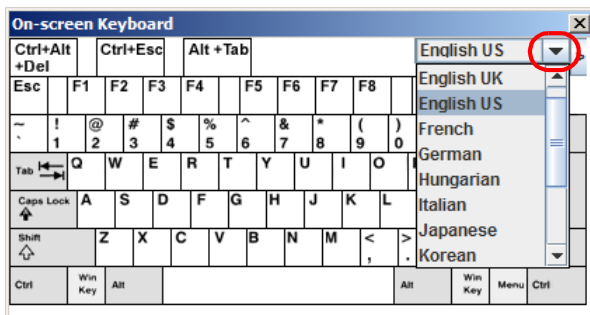

2. Select the new language from the list.

Expanded Keyboard

To display/hide the expanded keyboard keys, click the arrow to the right of the language list arrow.

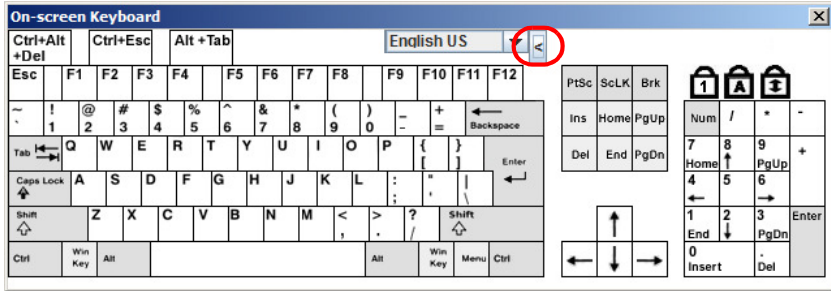



Mouse Pointer Type

KVM Over the NET™ switches offer a number of mouse pointer options when working in the remote display. Click this icon to select from the available choices:

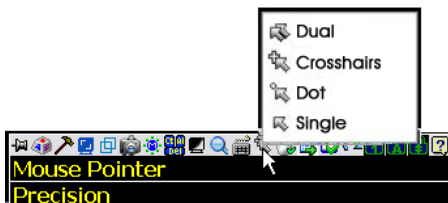

- Note:**
1. Before accessing a port, only Dual and Crosshairs are available for the Windows Viewers. Once the port is accessed, all four pointers are available.
 2. The Dot pointer is not available with the Java Applet Viewer or the Java Client AP.
 3. Selecting the Dot pointer has the same effect as the *Toggle mouse display* hotkey function (see *Toggle Mouse Display*, page 71 for details).
 4. The icon on the Control Panel changes to match your choice.



Mouse DynaSync Mode

Synchronization of the local and remote mouse pointers is accomplished either automatically or manually.



Automatic Mouse Synchronization (DynaSync)

Mouse DynaSync provides automatic locked-in syncing of the remote and local mouse pointers – eliminating the need to constantly resync the two movements.

Note: This feature is only available for Windows and Mac systems (G4 and higher) whose adapter attribute OS setting is configured for Win or Mac, which are connected to the switch with one of the following Adapter Cables: KA7170 or KA9170.

All other configurations must use manual mouse synchronization (described in the next section).

The icon on the Control Panel indicates the synchronization mode status as follows:

Icon	Function
	This icon displays in gray to indicate that Mouse DynaSync is not available – you must use manual syncing procedures. This is the default setting for all KVM Adapters other than the KA7170 and KA9170.
	The green check mark on this icon indicates that Mouse DynaSync is available and is enabled . This is the default setting when Mouse DynaSync is available. (See the Note, above.)
	The red X on this icon indicates that Mouse DynaSync is available but is not enabled .

When *Mouse DynaSync* is available, clicking the icon toggles its status between enabled and /disabled. If you choose to disable Mouse DynaSync mode, you must use the manual syncing procedures described under *Manual Mouse Synchronization*, page 89.

Mac and Linux Considerations

- ◆ For Mac OS versions 10.4.11 and higher, there is a second DynaSync setting to choose from. If the default Mouse DynaSync result is not satisfactory, try the **Mac 2** setting. To select Mac 2, right click in the text area of the Control Panel and select *Mouse Sync Mode* → *Automatic for Mac 2*:

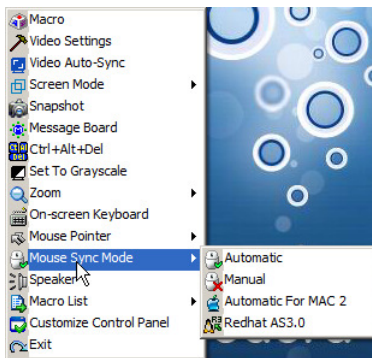

- ◆ Linux doesn't support DynaSync Mode, but there is a setting on the Mouse Sync Mode menu for Redhat AS3.0 systems. If you are using a USB Adapter Cable (see the Note on the previous page), with an AS3.0 system and the default mouse synchronization is not satisfactory, you can try the Redhat AS3.0 setting. In either case, you must perform the manual mouse synchronization procedures described in the next section.

Manual Mouse Synchronization

If the local mouse pointer goes out of sync with the remote system's mouse pointer there are a number of methods to bring them back into sync:

1. Perform a video and mouse auto sync by clicking the *Video Settings* icon on the Control Panel (see page 79).
2. Perform an *Auto Sync* with the Video Adjustment function (see *Video Settings*, page 79, for details).
3. Invoke the *Adjust Mouse* function with the *Adjust Mouse* hotkeys (see *Adjust Mouse*, page 71, for details).
4. Move the pointer into all 4 corners of the screen (in any order).
5. Drag the Control Panel to a different position on the screen.
6. Set the mouse speed and acceleration for each problematic server attached to the switch. See *Additional Mouse Synchronization Procedures*, page 177, for instructions.

Control Panel Configuration

Clicking the *Control Panel* icon brings up a dialog box that allows you to configure the items that appear on the Control Panel, as well as its graphical settings:

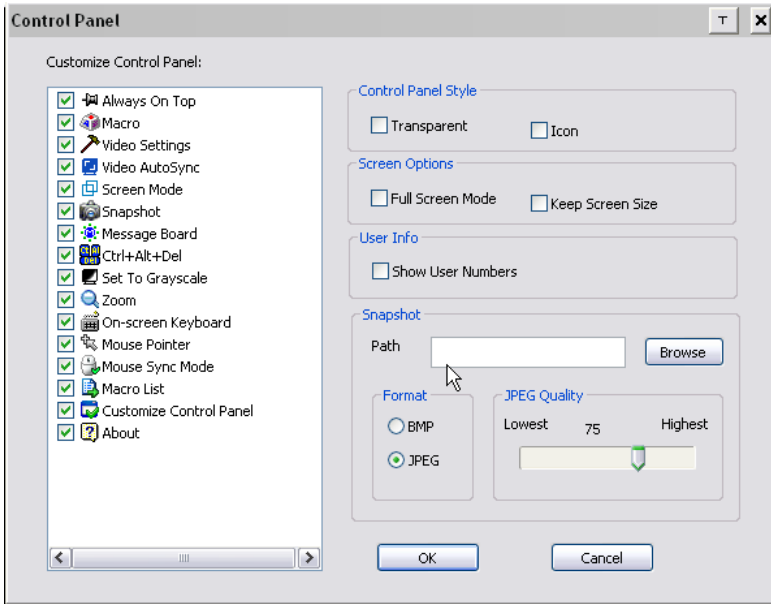

The organization of the dialog box is described in the table, below:

Item	Description
Customize Control Panel	Allows you to select which icons display in the Control Panel. Check the ones you want to see, uncheck the ones you don't want.
Control Panel Style	<ul style="list-style-type: none"> Enabling <i>Transparent</i> makes the Control Panel semi-transparent, so that you can see through it to the display underneath. Enabling <i>Icon</i> causes the Control Panel to display as an icon until you mouse over it, when the full panel then comes up.

Item	Description
Screen Options	<ul style="list-style-type: none"> ◆ If <i>Full Screen Mode</i> is enabled, the remote display fills the entire screen. ◆ If <i>Full Screen Mode</i> is not enabled, the remote display appears as a window on the local desktop. If the remote screen is larger than what is able to fit in the window, move the mouse pointer to the screen border that is closest to the area you want to view and the screen will scroll. ◆ If <i>Keep Screen Size</i> is enabled, the remote screen is not resized. <ul style="list-style-type: none"> ◆ If the remote resolution is smaller than that of the local monitor, its display appears like a window centered on the screen. ◆ If the remote resolution is larger than that of the local monitor, its display is centered on the screen. To access the areas that are off screen, move the mouse to the corner of the screen that is closest to the area you want to view and the screen will scroll. ◆ If <i>Keep Screen Size</i> is not enabled, the remote screen is resized to fit the local monitor's resolution.
User Info	<p>If <i>User Info</i> is enabled, the total number of users displays on the bottom row center of the Control Panel.</p>
Snapshot	<p>These settings let the user configure the KH1508Ai / KH1516Ai's screen capture parameters (see the <i>Snapshot</i> description under <i>The Control Panel</i>, page 66):</p> <ul style="list-style-type: none"> ◆ Path lets you select a directory that the captured screens automatically get saved to. Click Browse; navigate to the directory of your choice; then click OK. If you don't specify a directory here, the snapshot is saved to your desktop. ◆ Click a radio button to choose whether you want the captured screen to be saved as a BMP or a JPEG (JPG) file. ◆ If you choose JPEG, you can select the quality of the captured file with the slider bar. The higher the quality, the better looking the image, but the larger the file size.

The Java Control Panel

The Java Client AP Control Panel is similar to the one used by the WinClient:

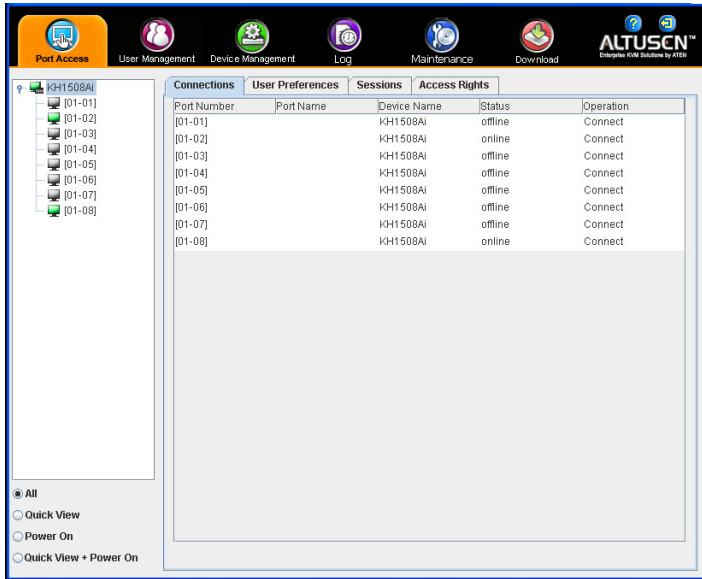

The major differences between them are:

- ◆ In the Macros dialog box, *Toggle Mouse Display* is not available.
- ◆ The *Dot* mouse pointer type is not available.
- ◆ In the Message Board, there is no *Show/Hide* button to show or hide the user list. This function is achieved by clicking the arrows at the top of the bar that separates the User List panel from the Main panel.
- ◆ The Control Panel *Lock LED* icons are not in sync with your keyboard. When you first connect, the LED display may not be accurate. To be sure, click on the LED icons to set them.
- ◆ In *Control Panel Configuration*, the BMP Snapshot format has been replaced by PNG.

Chapter 7

Port Access

Overview

When you log in to the switch the *Port Access* page comes up with the KH1508Ai / KH1516Ai's KVM *Connections* page displayed.

Browser GUI

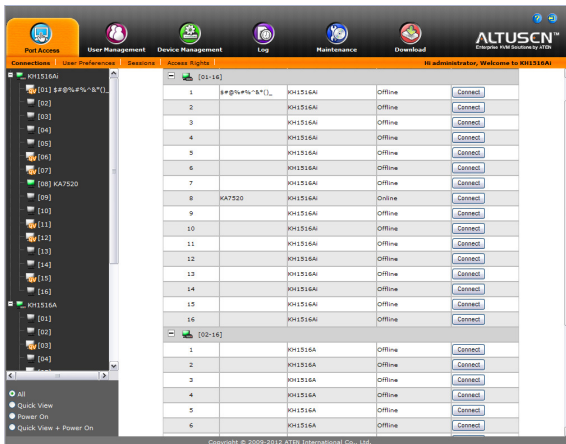

AP GUI

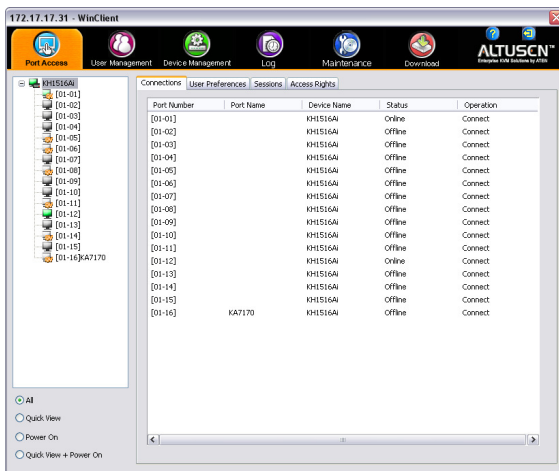

The Connections page is organized into several main areas. All the devices and ports that a user is permitted to access are listed in the Sidebar at the left of the page. After selecting a device or port in the Sidebar, clicking entries on the menu bar (Browser GUI) or tab bar (AP GUI) opens information and configuration pages related to the item selected in the Sidebar.

The Sidebar

All KVM switches are listed in a tree structure in the Sidebar at the left of the screen:

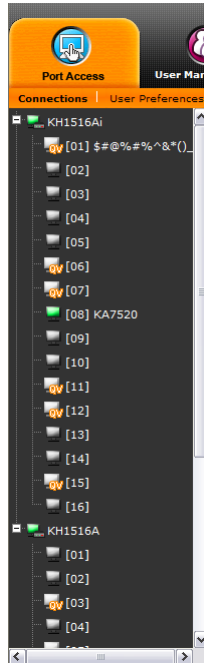

The Sidebar Tree Structure

- ◆ Users are only allowed to see the devices and ports that they have access permission for.
- ◆ Ports and chained station devices can be nested under their first station devices.

Click the + in front of a device to expand the tree and see the ports/outlets nested underneath it. Click the - to collapse the tree and hide the nested ports/outlets.

- ◆ A port's ID number is displayed in brackets next to its icon.
- ◆ Switches and ports that are on line have their monitor screen icons in Green; the monitor screens are Gray for devices and ports that are offline.
- ◆ Outlets that are *On* have their icons in Amber; the icons are Gray for outlets that are *Off*.

- ◆ To access and operate a port, double click its icon. Port operation details are discussed in Chapter 13, *Port Operation*.

View Filter

At the bottom of the sidebar are the viewing filter options which allow you to control the number and type of ports that display in the Sidebar:

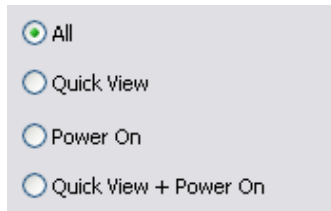

The meanings of the choices are explained in the following table:

Choices	Explanation
ALL	Lists all of the ports on the installation.
QUICK VIEW	Lists only the ports that have been selected as Quick View Ports (see <i>SET QUICK VIEW PORTS</i> , page 34).
POWER ON	Lists only the ports that have attached computers Powered On.
QUICK VIEW + POWER ON	Lists only the ports that have been selected as Quick View Ports (see <i>SET QUICK VIEW PORTS</i> , page 34), and that have their attached computers Powered On.

Connections

For the KH1508Ai / KH1516Ai, the *Connections* page displays port status information at the device level, and port connection configuration options at the port level.

Device Level

When a KH1508Ai / KH1516Ai is selected in the Sidebar, the Connections page displays a list of ports for the device that the user is authorized to access or view.

Port Number	Port Name	Device Name	Status	Operation
☰ [01-16]				
1	PMSSPS	KH1516Ai	Offline	Connect
2		KH1516Ai	Offline	Connect
3		KH1516Ai	Offline	Connect
4		KH1516Ai	Offline	Connect
5		KH1516Ai	Offline	Connect
6		KH1516Ai	Offline	Connect
7		KH1516Ai	Offline	Connect
8	KA7520	KH1516Ai	Online	Connect
9		KH1516Ai	Offline	Connect
10		KH1516Ai	Offline	Connect
11		KH1516Ai	Offline	Connect
12		KH1516Ai	Offline	Connect
13		KH1516Ai	Offline	Connect
14		KH1516Ai	Offline	Connect
15		KH1516Ai	Offline	Connect
16		KH1516Ai	Offline	Connect

The following attributes are listed for each device:

- ◆ Port Number – the port’s number on the switch.
- ◆ Port Name – if a name has been assigned to a port it displays here.
- ◆ Device Name – if a name has been assigned to the switch it displays here.
- ◆ Status – the current status of the port – online, or offline.
- ◆ Operation – You can access any port from the main panel by clicking **Connect**.

Note: The sort order of the information displayed can be changed by clicking the column headings.

Port Level

When a port is selected in the Sidebar, the *Connections* page displays port connection configuration properties:

Port Configuration

Port ID:	01-01
Port Status:	Offline
Adapter Type:	N/A
Port Name:	PMSSPS
Port OS:	Sun
OS Language:	English (US)
Cable Length:	Short
Access Mode:	Share

This page allows you to view the port's current configuration only. See *Port Configuration*, page 131, for full details about the properties and how to configure them.

Click the **Connect** button to view the port display via the KH1508Ai / KH1516Ai's built-in Win Viewer (when using Windows Internet Explorer), or Java Viewer (when using other web browsers).

User Preferences

The *User Preferences* page allows users to set up their own, individual, working environments. The switch stores a separate configuration record for each user profile, and sets up the working configuration according to the *Username* that was keyed into the Login dialog box:

Password

Old Password:

New Password:

Confirm Password:

[Save](#)

Device Setting

Language:

OSD Hotkey:

ID Display:

ID Duration: sec

Scan Select:

Scan Duration: sec

Screen Blanker: min

Logout Timeout: min

Viewer Auto Detect Java Client

Welcome Message Hide Show

[Save](#)

The page settings are explained in the following table:

Setting	Function
Changing a Password	<ul style="list-style-type: none"> ◆ In the Browser GUI, to change a user's password, key in the old password and new password into their input boxes; key the new password into the <i>Confirm</i> input box, then click Change Password to apply the change. ◆ In the AP GUI version, click Change Password; key in the old password and new password into their input boxes; key the new password into the <i>Confirm</i> input box, then click Save.
Language	Selects the language that the interface displays in.
OSD Hotkey	Selects which Hotkey controls the OSD function: [Scroll Lock] [Scroll Lock] is the default. To select a different combination, click the arrow at the right of the box to drop down the list of choices.
ID Display	Selects how the Port ID is displayed: the Port Number alone (PORT NUMBER); the Port Name alone (PORT NAME); or the Port Number plus the Port Name (PORT NUMBER + PORT NAME). The default is PORT NUMBER + PORT NAME.

Setting	Function
ID Duration	Determines how long a Port ID displays on the monitor after a port change has taken place. You can choose an amount from 1—255 seconds. The default is 3 Seconds. A setting of 0 (zero) means the Port ID is always on.
Scan Duration	Determines how long the focus dwells on each port as it cycles through the selected ports in Auto Scan Mode (see <i>Auto Scanning</i> , page 151). Key in a value from 1—255 seconds. The default is 5 seconds; a setting of 0 disables the Scan function.
Screen Blanker	If there is no input from the console for the amount of time set with this function, the screen is blanked. Key in a value from 1—30 minutes. A setting of 0 disables this function. The default is 0 (disabled). Note: Although this function can be set from either the local console or a remote login, it only affects the local console monitor.
Logout Timeout	If there is no user input for the amount of time set with this function, the user is automatically logged out. A login is necessary before the KH1508Ai / KH1516Ai can be accessed again.
Viewer*	You can choose which viewer is used when accessing a server: <ul style="list-style-type: none"> ◆ Auto Detect will select the appropriate viewer based on the web browser used; WinClient for Windows Internet Explorer, Java Client for other web browsers (ex. Firefox). ◆ Java Client will open the Java based viewer regardless of the web browser being used.
Welcome Message*	You can choose to hide or show the welcome message displayed in the submenu bar. The default is disabled.
Save	Click Save to save any changes made to the User Preferences settings.

* This item is only available with the Browser version.

Sessions

The *Session* page lets the administrator and users with User Management permissions see at a glance which users are currently logged into the KH1508Ai / KH1516Ai, and provides information about each of their sessions.

<input type="checkbox"/> Select	Username	IP	Login Time	Client	Category
<input type="checkbox"/>	administrator	10.0.13.226	10:01:16	Browser	Admin

-
- Note:**
1. The Session page isn't available for ordinary users.
 2. Users with User Management permissions can only see the sessions of ordinary users.
 3. The sort order of the information displayed can be changed by clicking the column headings.
-

The meanings of the headings at the top of the page are fairly straightforward. The *IP* heading refers to the IP address that the user has logged in from; the *Login Time* and *Client* tell you when and how the user logged in, and the *Category* heading lists the type of user who has logged in: Admin (Administrator); Normal user (User)

This page also gives the administrator the option of forcing a user logout by selecting the user and clicking **End Session** at the bottom of the main panel.







Access Rights

Administrators use the *Access Rights* page to set user access and configuration rights for ports.

Note: The Access page only appears for those users with User Management permissions. It isn't available for other users.

Browser GUI Interface

If a port is chosen in the Sidebar, the Main panel looks similar to the one shown below:

Name	Access Rights
 [01-02]	
 administrator	
 jonaschen	
 11111111	

The main panel consists of two columns: *Name*, and *Access Rights*:

- ◆ *Name* lists all the users that have been created.
- ◆ *Access Rights* indicates the users who have access rights privileges. A check mark (√) indicates that the user has permission to make changes to the switch configuration settings (see Chapter 9, *Device Management*); an X means that the user is denied permission to make configuration changes. Click the icon to toggle permission between Full Access, View Only, and No Access.

AP GUI Interface

The AP GUI *Access Rights* page is similar to the Browser GUI version (see above), except that there is no checkmark icon in the Access column.

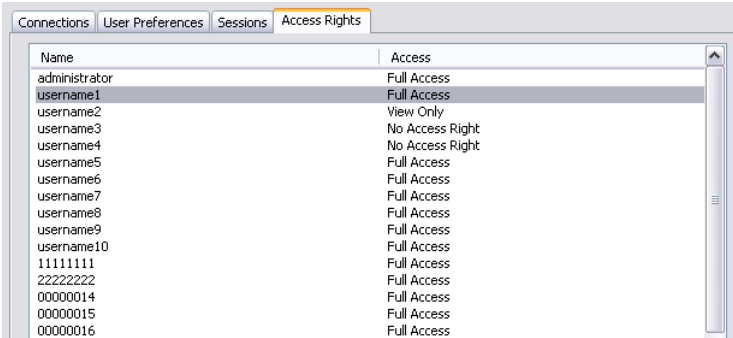

The screenshot shows a web interface with four tabs: 'Connections', 'User Preferences', 'Sessions', and 'Access Rights'. The 'Access Rights' tab is active. Below the tabs is a table with two columns: 'Name' and 'Access'. The table lists various users and their corresponding access levels.

Name	Access
administrator	Full Access
username1	Full Access
username2	View Only
username3	No Access Right
username4	No Access Right
username5	Full Access
username6	Full Access
username7	Full Access
username8	Full Access
username9	Full Access
username10	Full Access
11111111	Full Access
22222222	Full Access
00000014	Full Access
00000015	Full Access
00000016	Full Access

- ◆ Click the text in the *Access* column to toggle permission between Full Access, View Only, and No Access.

Saving Changes

Click the **Save** button at the lower right corner of the page to save any changes made on the Access page.

This Page Intentionally Left Blank

Chapter 8

User Management

Overview

When you select the *User Management* tab the screen comes up with the *Users* page displayed:

Browser GUI

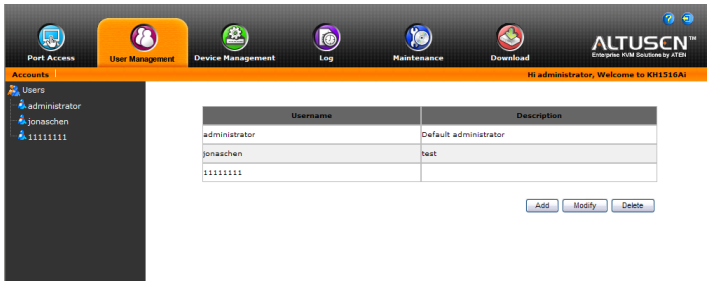

AP GUI

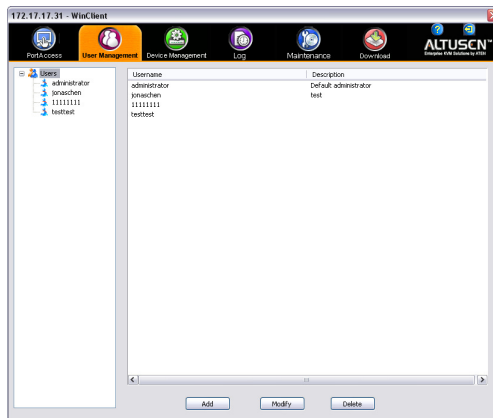

- ◆ Users appear in the panel at the left of the page. The large panel at the right provides more detailed information at-a-glance for each.
- ◆ The buttons below the main panel are used to manage users , as shown in the sections that follow.

Users

The KH1508Ai / KH1516Ai supports two types of user, as shown in the table, below:

User Type	Role
Administrator	Access and manage ports and devices. Manage Users, and Groups. Configure the overall installation. Configure personal working environment.
User	Access authorized ports and devices. Manage authorized ports and devices; configure personal working environment. Note: Users who have been given permission to do so, may also manage other users.

Adding Users

To add user, and assign user permissions, do the following:

1. Select *Users* on the menu bar (Browser GUI)

– or –

Select *Users* in the Sidebar (AP GUI).

2. To add a user, click **Add** at the bottom of the main panel. The User notebook opens, with the *User* tab selected:

The screenshot shows the 'User' management interface with the following sections:

- User Information:**
 - Username:
 - Password:
 - Confirm Password:
 - Description:
- Role:**
 - Administrator
 - User
- Permissions:**
 - Device Management
 - User Management
 - System Log
 - Maintenance
 - Power Management
 - Windows Client
 - Java Client

A **Save** button is located at the bottom right of the form.

3. Enter the required information in the appropriate fields. A description of each of the fields is given in the table below:

Field	Description
Username	Enter a username with a minimum of 6 and maximum of 16 characters.
Password	Enter a password with a minimum of 6 and maximum of 16 characters.
Confirm Password	To be sure there is no mistake in the password, you are asked to enter it again. The two entries must match.
Description	Additional information about the user that you may wish to include.
Role	<p>There are two categories: Administrator and User. There is no limitation on the number of accounts that can be created in each category.</p> <ul style="list-style-type: none"> ◆ The Administrator is responsible for the overall installation configuration and maintenance; user management; and device and port assignments. The Administrator's permissions (see page 108) are automatically assigned by the system and cannot be altered. ◆ The default permissions for Users include the Win, Java, and SSH clients, but the permissions can be altered for each User by checking or unchecking any of the permissions checkboxes. <p>Note: Users who have been given User Management privileges cannot access or configure Groups.</p>

Field	Description
<p>Permissions</p> <p>Note: For ordinary users, in addition to enabling <i>Device Management</i>, <i>Port Configuration</i>, and <i>Maintenance</i> permissions, the user must also be given those rights for each device and port that he will be allowed to manage. See <i>Device Assignment</i>, page 110 for details.</p>	<ul style="list-style-type: none"> ◆ Enabling <i>Device Management</i> allows a user to configure and control the settings for overall KH1508Ai / KH1516Ai operations (see <i>Device Management</i>, page 113). ◆ Enabling <i>User Management</i> allows a user to create, modify, and delete user and group accounts. ◆ Enabling <i>System Log</i> allows a user to access the system log (see <i>Log</i>, page 135). ◆ Enabling <i>Maintenance</i> allows a user to perform all the Maintenance operations available under the Maintenance tab (see <i>Maintenance</i>, page 137). ◆ Enabling <i>Power Management</i> allows a user to download the PoN AP to link to a Power Over the Net™ login screen. (see the ATEN website for more information about the PN series of Power Distribution Units) ◆ Enabling <i>Windows Client</i> allows a user to download the Windows Client AP software, and access the KH1508Ai / KH1516Ai with it, in addition to (or instead of) the browser access method. ◆ Enabling <i>Java Client</i> allows a user to download the Java Client AP software, and access the KH1508Ai / KH1516Ai with it, in addition to (or instead of) the browser access method.

4. When your selections have been made click **Save**.
5. When the *Operation Succeeded* message appears, click **OK**.
6. Click **Users** in the Sidebar to return to the main screen. The new user appears in the Sidebar list and in the main panel, as well.
 - ◆ The Sidebar *Users* list can expand and collapse. If the list is expanded, click the minus symbol (–) next to the *Users* icon to collapse it; if it is collapsed there is a plus symbol (+) next to the icon. Click the plus symbol to expand it.
 - ◆ The icon for administrators has one red band.
 - ◆ The large main panel shows the user's name; the description that was given when the account was created; and whether the account is currently active or has been disabled.

Modifying User Accounts

To modify a user account, do the following:

1. In the Sidebar *User* list, click the user's name
 - or –

In the main panel, select the user's name

2. Click **Modify**.
3. In the *User* page that comes up, make your changes, then click **Save**.

Note: The *User* page is discussed on page 106; the *Devices* page is discussed on page 110.

Deleting User Accounts

To delete a user account do the following:

1. In the main panel, select the user's name.
2. Click **Delete**.
3. Click **OK**.

To delete a group do the following:























Device Assignment

When a user logs in to the KH1508Ai / KH1516Ai, the interface comes up with the Port Access page displayed. All the ports that the user is permitted to access are listed in the Sidebar at the left of the page. Access permissions for those ports and the devices connected to them are assigned on a port-by-port basis from the *User* list on the Sidebar of the User Management page.

Assigning Device Permissions From the User's Notebook

To assign a device permissions to a user from the *User's* notebook, do the following:



1. In the Sidebar *User* list, click the user's name
– or –
In the main panel, select the user's name.
2. Click **Modify**.
3. In the *User* notebook that comes up, select the *Devices* tab. A screen, similar to the one below, appears:

Name	Access Rights
☰  [01-16]	
 [01] PMSSPS	
 [02]	
 [03]	
 [04]	
 [05]	
 [06]	
 [07]	
 [08] KA7520	
 [09]	
 [10]	
 [11]	

4. Make your permission settings for each port according to the information provided below:

Name: Each port accessible to the user is listed under the *Names* column.

Access: The *Access* column is where device access rights are set. Click the icon in the row that corresponds to the port you want to configure to cycle through the choices. The meanings of the icons are described in the table, below:

	Full Access	The user can view the remote screen and can perform operations on the remote server from his keyboard and monitor.
	View Only	The user can only view the remote screen and cannot perform any operations on it.
	No Access	No access rights – the Port will not show up on the User's list on the Main Screen.

5. When you have finished making your choices, click **Save**.
6. In the confirmation popup that appears, click **OK**.

Note: In any of the columns, you can use Shift-Click or Ctrl-Click to select a group of ports to configure. Clicking to cycle through the choices on any one of the selected ports causes all of them to cycle in unison.

This Page Intentionally Left Blank

Chapter 9 Device Management

KVM Devices

Device Information

The Device Management page opens with the top level KH1508Ai / KH1516Ai selected in the Sidebar and the *Device Configuration* item selected on the menu bar:

Browser GUI

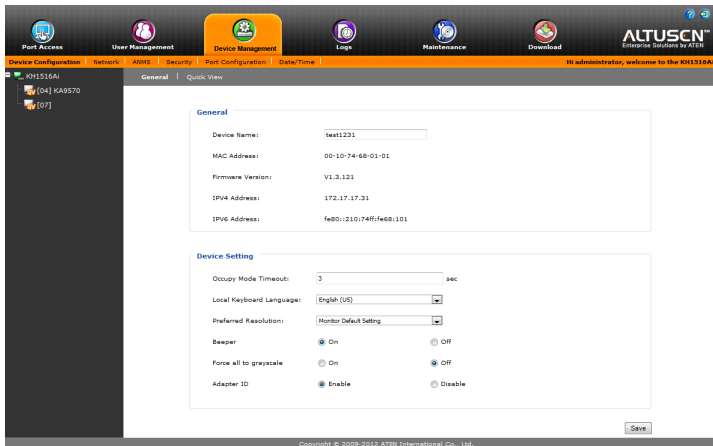

AP GUI

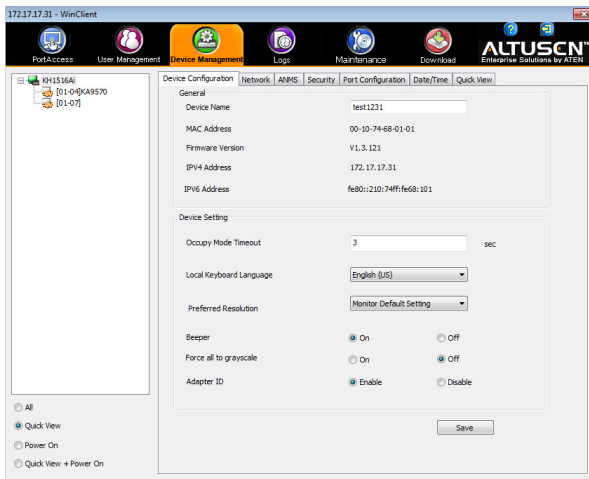

General

The *General* section of the Device Management page displays the name of the selected device, its firmware version, and information about its network configuration.

Note: The AP GUI version presents the same information as the Browser version. Scroll through the list to see the additional entries.

Device Setting

The lower panel presents information concerning the device's settings, as described, below:

- ◆ Use *Occupy Timeout Mode* to set a time threshold for users on ports whose Operation Mode has been set to Occupy (See *Port Configuration*, page 131). If there is no activity from the user occupying the port for the amount of time set here, the user is timed out and keyboard and mouse control on the port is released, after which the first user to send keyboard or mouse input will occupy the port. However, the user originally connected to the port will still see the port's video output. The default is 3 minutes.
- ◆ Use *Local Keyboard Language* to select the language for the local keyboard from the drop-down menu. The default is English (US).
- ◆ *Preferred Resolution* allows you to set a resolution that the switch sends to the KVM adapter cables. The adapter cables provide the connected computer's video card information about the monitor connected to the switch. This affects the video quality of the console monitor.
 - ◆ *Monitor Default Setting*: Sends the EDID information provided by the display connected to the console port – to the KVM adapter cable.
 - ◆ *Alternative Resolution*: Sends an alternative resolution (EDID information) to the KVM adapter cables. Select a resolution that best suits the video displayed on the monitor connected to the console port.
- ◆ Turns the *Beeper* on or off.
- ◆ If *Force all to grayscale* is enabled, the remote displays of all devices connected to the KH1508Ai / KH1516Ai are changed to grayscale. This can speed up I/O transfer in low bandwidth situations.
- ◆ If the *Adapter ID* function is enabled (the default), the switch stores adapter cable information for each of its ports, so that when you move a KVM Adapter Cable from one port to another, it remembers the adapter cable's port properties information at the new location.

Network

The Network page is used to specify the network environment.

IP Installer

Enabled

View Only

Disabled

Service Ports

Program:

HTTP:

HTTPS:

Network Configuration

IPv4 Configuration

Obtain IP address automatically [DHCP]

Set IP address manually [Fixed IP]

IP Address:

Subnet Mask:

Default Gateway:

Obtain DNS server address automatically

Set DNS server address manually

Preferred DNS server:

Alternate DNS server:

IPv6 Configuration

Obtain IP address automatically [DHCP]

Set IP address manually [Fixed IP]

IP Address:

Prefix Length:

Default Gateway:

Obtain DNS server address automatically

Set DNS server address manually

Preferred DNS server:

Alternate DNS server:

Each of the elements on this page is described in the sections that follow.

IP Installer

The IP Installer is an external Windows-based utility for assigning IP addresses to the KH1508Ai / KH1516Ai.

Click one of the radio buttons to select *Enable*, *View Only*, or *Disable* for the IP Installer utility. See *IP Installer*, page 179, for IP Installer details.

-
- Note:** 1. If you select *View Only*, you will be able to see the KH1508Ai / KH1516Ai in the IP Installer's Device List, but you will not be able to change the IP address.
2. For security, we strongly recommend that you set this to *View Only* or *Disable* after each use.
-

Service Ports

As a security measure, if a firewall is being used, the Administrator can specify the port numbers that the firewall will allow. If a port other than the default is used, users must specify the port number as part of the IP address when they log in. If an invalid port number (or no port number) is specified, the KH1508Ai / KH1516Ai will not be found. An explanation of the fields is given in the table below:

Field	Explanation
Program	This is the port number for connecting with the WinClient ActiveX Viewer, WinClient AP, Java Applet Viewer, Java Client AP, or via Virtual Media. The default is 9000.
HTTP	The port number for a browser login. The default is 80.
HTTPS	The port number for a secure browser login. The default is 443.

-
- Note:** 1. Valid entries for all of the Service Ports are from 1–65535.
2. Service ports cannot have the same value. You must set a different value for each one.
3. If there is no firewall (on an Intranet, for example), it doesn't matter what these numbers are set to, since they have no effect.
-

Network Configuration

- ◆ IPv4 Settings

- ◆ IP Address:

IPv4 is the traditional method of specifying IP addresses. The KVM Over the NET™ switch can either have its IP address assigned dynamically (DHCP), or it can be given a fixed IP address.

- ◆ For dynamic IP address assignment, select the *Obtain IP address automatically* radio button. (This is the default setting.)
 - ◆ To specify a fixed IP address, select the *Set IP address manually* radio button and fill in the fields with values appropriate for your network.

Note: If the switch is on a network that uses DHCP to assign network addresses, and you need to ascertain its IP address, see *IP Address Determination*, page 179, for information./

- ◆ DNS Server

- ◆ For automatic DNS Server address assignment, select the *Obtain DNS Server address automatically* radio button.
 - ◆ To specify the DNS Server address manually, select the *Set DNS server address manually* radio button, and fill in the addresses for the Preferred and Alternate DNS servers with values appropriate for your network.

Note: Specifying the Alternate DNS Server address is optional.

- ◆ IPv6 Settings

- ◆ IP Address:

IPv6 is the new (128-bit) format for specifying IP addresses. The KVM Over the NET™ switch can either have its IPv6 address assigned dynamically (DHCP), or it can be given a fixed IP address.

- ◆ For dynamic IP address assignment, select the *Obtain IP address automatically* radio button. (This is the default setting.)
 - ◆ To specify a fixed IP address, select the *Set IP address manually* radio button and fill in the fields with values appropriate for your network.
- ◆ DNS Server
 - ◆ For automatic DNS Server address assignment, select the *Obtain DNS Server address automatically* radio button.
 - ◆ To specify the DNS Server address manually, select the *Set DNS server address manually* radio button, and fill in the addresses for the Preferred and Alternate DNS servers with values appropriate for your network.

Note: Specifying the Alternate DNS Server address is optional.

ANMS

The ANMS (Advanced Network Management Settings) page is used to set up login authentication and authorization management from external sources. It is organized as described, below:

Event Destination

The screenshot shows the 'Event Destination' configuration page. At the top, there are two tabs: 'Event Destination' (selected) and 'Authentication'. The main content area is titled 'Event Destination' and contains the following elements:

- A checkbox labeled 'Enable Log Server' which is currently unchecked.
- A text input field labeled 'MAC Address' containing the value '000000000000'.
- A text input field labeled 'Service Port' containing the value '9001'.
- A 'Save' button located at the bottom right of the form.

◆ Log Server

When *Enable Log Server* is checked, important transactions that occur on the KH1508Ai / KH1516Ai, such as logins and internal status messages, are kept in an automatically generated log file.

- ◆ Specify the MAC address of the computer that the Log Server runs on in the *MAC address* field.
- ◆ Specify the service port used by the computer that the Log Server runs on to listen for log details in the *Port* field. The valid port range is 1–65535. The default port number is 9001.

Note: The port number must differ than the one used for the *Program* port (see *Program*, page 116).

See Chapter 14, *The Log Server*, for details on setting up the log server. The Log File is discussed on page 135.

Authentication and Authorization

- ◆ Disable Local Authentication

Selecting this option disables login authentication on the KH1508Ai / KH1516Ai. The switch can only be accessed using LDAP, LDAPS, MS Active Directory, RADIUS or CC Management authentication.

- ◆ RADIUS Settings

RADIUS Settings

Enable

Preferred RADIUS Server IP:

Preferred RADIUS Service Port:

Alternate RADIUS Server IP:

Alternate RADIUS Service Port:

Timeout(seconds):

Retries:

Shared Secret (at least 6 characters):

To allow authentication and authorization for the KH1508Ai / KH1516Ai through a RADIUS server, do the following:

1. Check **Enable**.
2. Fill in the IP addresses and service port numbers for the Preferred and Alternate RADIUS servers. You can use the IPv4 address, the IPv6 address or the domain name in the IP fields.
3. In the *Timeout* field, set the time in seconds that the KH1508Ai / KH1516Ai waits for a RADIUS server reply before it times out.
4. In the *Retries* field, set the number of allowed RADIUS retries.
5. In the *Shared Secret* field, key in the character string that you want to use for authentication between the KH1508Ai / KH1516Ai and the RADIUS Server. A minimum of 6 characters is required.

(Continues on next page.)

(Continued from previous page.)

6. On the RADIUS server, Users can be authenticated with any of the following methods:
 - ◆ Set the entry for the user as **su/xxxx**
 - ◆ Where **xxxx** represents the Username given to the user when the account was created on the KH1508Ai / KH1516Ai.
 - ◆ Use the same Username on both the RADIUS server and the KH1508Ai / KH1516Ai.
- ◆ LDAP / LDAPS Authentication and Authorization Settings

LDAP/AD Settings

Enable

LDAP LDAPS

Enable Authorization

Server IP:

Server Port:

Timeout(seconds):

Admin DN:

Password:

Search DN:

Admin Group:

To allow authentication and authorization for the KH1508Ai / KH1516Ai via LDAP / LDAPS, refer to the information in the table, below:

Item	Action
Enable	Put a check in the <i>Enable</i> checkbox to allow LDAP / LDAPS authentication and authorization.
Type	Click a radio button to specify whether to use LDAP or LDAPS.
LDAP Server IP and Port	Fill in the IP address and port number for the LDAP or LDAPS server. <ul style="list-style-type: none"> ◆ You can use the IPv4 address, the IPv6 address or the domain name in the <i>LDAP Server</i> field. ◆ For LDAP, the default port number is 389; for LDAPS, the default port number is 636.
Timeout	Set the time in seconds that the KH1508Ai / KH1516Ai waits for an LDAP or LDAPS server reply before it times out.
Admin DN	Consult the LDAP / LDAPS administrator to ascertain the appropriate entry for this field. For example, the entry might look like this: ou=kh1516ai,dc=aten,dc=com
Admin Name	Key in the LDAP administrator's username.
Password	Key in the LDAP administrator's password.
Search DN	Set the distinguished name of the search base. This is the domain name where the search starts for user names.
Admin Group	Key in the Group Name for KH1508Ai / KH1516Ai administrator users. If <i>Enable Authorization</i> is not checked, this field is used to authorize users that are logging in. If a user is in this group, the user receives full access rights. If a user is not in this group, the user only receives limited access rights. Consult the LDAP / LDAPS administrator to ascertain the appropriate value.

(Continues on next page.)

(Continued from previous page.)

On the LDAP / LDAPS server, Users can be authenticated with the following method:

- ◆ With MS Active Directory schema.

CC Management Settings

To allow authorization for the KH1508Ai / KH1516Ai through a CC (Control Center) server, check *Enable* and fill in the CC Server's IP address and Service port in the appropriate fields. You can use the IPv4 address, the IPv6 address or the domain name in the *CC Server IP* field.

Security

The Security page is divided into six main panels, as described in the sections that follow.

Login Failures

For increased security, the Login Failures section allows administrators to set policies governing what happens when a user fails to log in successfully.

Login Failures

Login Fail Policy: Disable User Account IP Address Locked

Allowed:

Timeout: min

To set the Login Failures policy, check the *Enable* checkbox (the default is for Login Failures to be enabled). The meanings of the entries are explained in the table below:

Entry	Explanation
Disable User Account	If this is enabled, after the allowed number of failures have been exceeded, the user attempting to log in is automatically locked out. No logins from the username and password that have failed will be accepted. The default is enabled.
IP Address Locked	If this is enabled, after the allowed number of failures have been exceeded, the computer attempting to log in from that IP is automatically locked out. No logins from that computer will be accepted. The default is enabled. Note: If the IP is changed, the computer will no longer be locked out.
Allowed	Sets the number of consecutive failed login attempts that are permitted from a remote computer. The default is 5 times.
Timeout	Sets the amount of time a remote computer must wait before attempting to login again after it has exceeded the number of allowed failures. The default is 3 minutes.

Note: If Login Failures is not enabled, users can attempt to log in an unlimited number of times with no restrictions. For security purposes, we recommend that you enable this function and enable the lockout policies.

Login String

The *Login String* entry field lets the super administrator specify a login string (in addition to the IP address) that users must add to the IP address when they access the KH1508Ai / KH1516Ai with a browser.

For example, if *192.168.0.126* were the IP address, and *abcdefg* were the login string, then the user would have to key in:

```
192.168.0.126/abcdefg
```

Note: 1. Users must place a forward slash between the IP address and the string.

2. If no login string is specified here, anyone will be able to access the KH1508Ai / KH1516Ai login page using the IP address alone. This makes your installation less secure.

The following characters are allowed in the string:

```
0-9 a-z A-Z ~ ! @ $ & * ( ) _ - = + [ ] , . |
```

The following characters are not allowed:

```
% ^ " ' / ? # \ ' { } ; ' < > [Space]
```

Compound characters (É Ç ñ ... etc.)

For security purposes, we recommend that you change this string occasionally.

Security

The screenshot shows a 'Security' configuration window. It contains two sections: 'IP Filter' and 'MAC Filter'. Each section has a checkbox for 'Filter Enable', radio buttons for 'Include' and 'Exclude' (with 'Exclude' selected), a large empty list box, and three buttons: 'Add', 'Modify', and 'Delete'.

◆ IP and MAC Filtering

IP and MAC Filters control access to the KH1508Ai / KH1516Ai based on the IP and/or MAC addresses of the client computers attempting to connect. A maximum of 100 IP filters and 100 MAC filters are allowed. If any filters have been configured, they appear in the IP Filter and/or MAC Filter list boxes.

To enable IP and/or MAC filtering, **Click** to put a check mark in the *IP Filter Enable* and/or *MAC Filter Enable* checkbox.

- ◆ If the include button is checked, all the addresses within the filter range are allowed access; all other addresses are denied access.
- ◆ If the exclude button is checked, all the addresses within the filter range are denied access; all other addresses are allowed access.

- ◆ Adding Filters

To add an IP filter, do the following:

1. Click **Add**. A script prompt dialog box appears.
2. Specify whether you are filtering an IPv4 or IPv6 address.
3. Key the address you want to filter in the *From:* field.
 - ◆ To filter a single IP address, click to put a check in the *Single IP* checkbox.
 - ◆ To filter a continuous range of addresses, key in the end number of the range in the *To:* field.

Note: This description is for the AP GUI. The Browser GUI differs as follows:

1. It doesn't offer an IPv4 or IPv6 choice. It only has *From* and *To* fields for IPv4 filtering.
 2. It doesn't have a checkbox to specify a single IP address. To filter a single IPv4 address, key the same address in both the *From* and *To* fields.
-

4. After filling in the address, click **OK**.
5. Repeat these steps for any additional IP addresses you want to filter.

To add a MAC filter, do the following:

1. Click **Add**. A script prompt dialog box.
2. Specify the MAC address in the dialog box, then click **OK**.
3. Repeat these steps for any additional MAC addresses you want to filter.

◆ IP Filter / MAC Filter Conflict

If there is a conflict between an IP filter and a MAC filter – in other words, if a computer’s address is allowed by one filter but blocked by the other – then the blocking filter takes precedence (the computer’s access is blocked).

◆ Modifying Filters

To modify a filter, select it in the IP Filter or MAC Filter list boxes and click **Modify**. The Modify dialog box is similar to the Add dialog box. When it comes up, simply delete the old address(es) and replace it with the new one(s).

◆ Deleting Filters

To delete a filter, select it in the IP Filter or MAC Filter list box and click **Delete**.

Encryption

Encryption

Keyboard/Mouse

DES
 3DES
 AES
 RC4
 Random

Video

DES
 3DES
 AES
 RC4
 Random

These flexible encryption alternatives for keyboard/mouse and video let you choose any combination of DES; 3DES; AES; RC4; or a Random cycle of any or all of them.

Enabling encryption affects system performance – no encryption offers the best performance; the greater the encryption the greater the adverse effect. If you enable encryption, the performance considerations are as follows:

- ◆ RC4 offers the least impact on performance; DES is next; then 3DES or AES
- ◆ The RC4 + DES combination offers the least impact of any combination

Working Mode

Working Mode

Enable ICMP
 Enable Browser
 Enable Multiuser Operation

An explanation of the Working Mode items is given in the table, below:

Item	Explanation
Enable ICMP	If <i>ICMP</i> is enabled , the KH1508Ai / KH1516Ai can be pinged. If it is not enabled, the device cannot be pinged. The default is Enabled.
Enable Multiuser Operation	Enabling <i>Multiuser operation</i> permits up to 32 users to log in at the same time to share the remote bus. If not enabled, only one user can log in at a time. The default is Enabled.
Enable Browser	Enabling <i>Browser</i> means browser access is permitted. If this is disabled, users must access the switch with an HTTP URL.

Private Certificate

When logging in over a secure (SSL) connection, a signed certificate is used to verify that the user is logging in to the intended site. For enhanced security, the *Private Certificate* section allows you to use your own private encryption key and signed certificate, rather than the default ATEN certificate.

There are two methods for establishing your private certificate: generating a self-signed certificate; and importing a third-party certificate authority (CA) signed certificate.

- ◆ **Generating a Self-Signed Certificate**

If you wish to create your own self-signed certificate, a free utility – openssl.exe – is available for download over the web. See *Self-Signed Private Certificates*, page 186 for details about using OpenSSL to generate your own private key and SSL certificate.

- ◆ **Obtaining a CA Signed SSL Server Certificate**

For the greatest security, we recommend using a third party certificate authority (CA) signed certificate. To obtain a third party signed certificate, go to a CA (Certificate Authority) website to apply for an SSL certificate. After the CA sends you the certificate and private encryption key, save them to a convenient location on your computer.

- ◆ **Importing the Private Certificate**

To import the private certificate, do the following:

1. Click **Browse** to the right of *Private Key*; browse to where your private encryption key file is located; and select it.
2. Click **Browse** to the right of *Certificate*; browse to where your certificate file is located; and select it.
3. Click **Upload** to complete the procedure.

Note: 1. Clicking **Restore Default** returns the device to using the default ATEN certificate.

2. Both the private encryption key and the signed certificate must be imported at the same time.
-

Port Configuration

The Port Configuration page displays status information and allows you to set the properties of a port that has been selected in the Sidebar.

Port Configuration

Port ID: 01-01

Port Status: Offline

Adapter Type: N/A

Adapter F/W Version: N/A

Port Name:

Port OS:

OS Language:

Cable Length:

Access Mode:

Exit Macro:

An explanation of the configuration fields is given in the table, below:

Field	Explanation
Port OS	Specifies the operating system that the server on the connected port is using. Choices are Win, Mac, Sun, and Other. The default is Win.
OS Language	Specifies the OS language being used by the server on the connected port. Drop down the list to see the available choices. The default is English US.
Cable Length	Specifies the length of the Cat5e/6 cable that is used to connect the server to the port. Choices are Short (less than 10 m), Medium (10–25 m), and Long (greater than 25 m). The default is Short. Note: Cable length can affect video quality. Generally speaking, shorter cables offer better quality. This setting is designed to compensate for longer or shorter cable lengths. You can experiment to find the setting that best suits your connection.
Access Mode	Defines how the port is to be accessed when multiple users have logged on, as follows: Exclusive: The first user to switch to the port has exclusive control over the port. No other users can view the port. The <i>Timeout</i> function does not apply to ports which have this setting. Occupy: The first user to switch to the port has control over the port. However, additional users may view the port's video display. If the user who controls the port is inactive for longer than the time set in the <i>Timeout</i> box, port control is transferred to the first user to move the mouse or strike the keyboard. Share: Users simultaneously share control over the port. Input from the users is placed in a queue and executed chronologically.
Exit Macro	The Exit Macro panel contains a drop-down list box of user created System macros. You can select a macro from the list that will execute when exiting the remote server. See <i>System Macros</i> , page 76 for details on creating exit macros.

Date/Time

The Date/Time dialog page sets the KH1508Ai / KH1516Ai time parameters. Set the parameters according to the information below.

Time Zone

Time Zone

(GMT+08 00) Taipei

Daylight Savings Time

- ◆ To establish the time zone that the KH1508Ai / KH1516Ai is located in, drop down the *Time Zone* list and choose the city that most closely corresponds to where it is at.
- ◆ If Daylight Savings Time (Summer Time) is currently in effect, check the corresponding checkbox. After the period of Daylight Savings Time ends (Winter Time), the checkbox should be unchecked.

Date

Date

September < 2010 >

September 2010

Su	Mo	Tu	We	Th	Fr	Sa
			1	2	3	4
5	6	7	8	9	10	11
12	13	14	15	16	17	18
19	20	21	22	23	24	25
26	27	28	29	30		

- ◆ Select the month from the dropdown listbox.
- ◆ Click < or > to move backward or forward by one year increments.
- ◆ In the calendar, click on the day.
- ◆ To set the time, use the 24 hour HH:MM:SS format.
- ◆ Click **Set** to save your settings.

Time

The screenshot shows a 'Time' configuration window. It contains three input fields for time: '15' in the first, '04' in the second, and '58' in the third. To the right of these fields is a 'Set' button.

To manually set the time, enter the values in the boxes and click **Set**.

Network Time

The screenshot shows a 'Network Time' configuration window. At the top, there is a checkbox for 'Enable Auto Adjustment'. Below it are two checked options: 'Preferred Time Server' with a dropdown menu showing 'US CA | timekeeper.isi.edu' and 'Preferred Custom Server IP' with an input field containing '128.4.1.1'. There are also two unchecked options: 'Alternate Time Server' with a dropdown menu showing 'US CA | clock.sjc.he.net' and 'Alternate Custom Server IP' with an empty input field. At the bottom, there is an 'Adjust Time Every' field set to '1' with the unit 'Hours' and an 'Adjust Time Now' button.

To have the time automatically synchronized to a network time server, do the following:

1. Check the *Enable auto adjustment* checkbox.
2. Drop down the time server list to select your preferred time server
– or –

Check the *Preferred custom server IP* checkbox, and key in either the IPv4 address, IPv6 address, or domain name of the time server of your choice.

3. If you want to configure an alternate time server, check the *Alternate time server* checkbox, and repeat step 2 for the alternate time server entries.
4. Key in your choice for the number of days between synchronization procedures.
5. If you want to synchronize immediately, click **Adjust Time Now**.

Set Quick View Ports

The *Quick View* tab in the Device Management page lets the administrator select which ports to include as quick view ports.

- ◆ To select/deselect a port as a quick view port, check the *Enable Quick View* box for that port.
- ◆ When a port has been selected as quick view, an icon appears next to the port number in the Sidebar and in the port list on the main screen. When a port is deselected, the icon disappears.
- ◆ Click *Save* at the bottom of the page to save your selections.

Chapter 10 Log

Overview

The KH1508Ai / KH1516Ai logs all the events that take place on it. To view the contents of the log, click the *Log* tab. The device's Log Information page, similar to the one below, appears:

Browser GUI

No.	Date/Time	Description
1	2010-09-27 13:36:13	Config version is v3
2	2010-09-27 13:36:20	DHCP ip_addr:10.3.42.190, net_mask:255.255.255.0
3	2010-09-27 13:36:20	DHCP gate_addr:10.3.42.254, dns_addr:10.3.152.2
4	2010-09-27 13:36:30	USB VNC cable connected at High Speed (USB2.0).
5	2010-09-27 13:36:37	Ntp Send Data failed
6	2010-09-27 13:36:47	Ntp Send Data failed
7	2010-09-27 16:38:01	Local User:administrator @ 10.0.13.226 logged in from web
8	2010-09-27 17:26:42	Web User: administrator @ 10.0.13.226 session timeout
9	2010-09-27 17:34:07	User:aten8006 @ 10.3.42.234 failed to log in from web
10	2010-09-27 17:34:13	Local User:administrator @ 10.3.42.234 logged in from web
11	2010-09-27 17:34:27	User:administrator @ 10.3.42.234 logged out from web
12	2010-09-28 10:01:16	Local User:administrator @ 10.0.13.226 logged in from web
13	2010-09-28 14:49:59	Port Configuration changed by: administrator @ 10.0.13.226
14	2010-09-28 14:46:00	Port Configuration changed by: administrator @ 10.0.13.226
15	2010-09-28 17:57:45	Web User: administrator @ 10.0.13.226 session timeout
16	2010-09-28 13:49:29	Local User:administrator @ 10.0.13.226 logged in from web
17	2010-09-28 17:59:39	Web User: administrator @ 10.0.13.226 session timeout
18	2010-09-30 12:02:05	Local User:administrator @ 10.0.13.226 logged in from web
19	2010-09-30 14:34:31	application Java Client downloaded by: administrator @ 10.0.13.226
20	2010-09-30 14:36:20	User:administrator @ 10.0.13.226 failed to log in from client

AP GUI

No.	Date/Time	Description
1	2010/10/01 21:59:30	Static ip_addr:172.17.17.31 net_mask:255.255.255.0
2	2010/10/01 21:59:30	Static gate_addr:172.17.254.1 dns_addr:10.3.152.2
3	2010/10/02 09:57:28	Web User: administrator connected from 10.0.13.185
4	2010/10/02 09:57:54	Client User: administrator connected from 10.0.13.185
5	2010/10/02 09:58:39	Client User: administrator @ 10.0.13.185 logged out
6	2010/10/02 09:59:03	Client User: administrator connected from 10.0.13.185
7	2010/10/02 09:59:03	Client User: administrator @ 10.0.13.185 logged out
8	2010/10/02 10:01:34	Client User: administrator connected from 10.0.13.185
9	2010/10/02 10:02:01	Client User: administrator @ 10.0.13.185 logged out
10	2010/10/02 10:02:29	Client User: administrator connected from 10.0.13.185
11	2010/10/02 10:02:19	Client User: administrator connected from 10.0.13.185
12	2010/10/02 10:02:19	Client User: administrator @ 10.0.13.185 logged out
13	2010/10/02 10:02:21	Client User: administrator connected from 10.0.13.185
14	2010/10/02 10:03:10	Client User: administrator @ 10.0.13.185 logged out
15	2010/10/02 10:03:11	Client User: administrator connected from 10.0.13.185
16	2010/10/02 10:06:22	Web User: administrator @ 10.0.13.189 logged in
17	2010/10/02 10:10:33	Web User: administrator @ 10.3.42.146 logged in
18	2010/10/02 10:12:03	User Preferences settings changed by: administrator @ 10.3.42.146
19	2010/10/02 10:12:10	User Preferences settings changed by: administrator @ 10.3.42.146
20	2010/10/02 10:12:16	Client User: administrator connected from 10.3.42.146
21	2010/10/02 10:12:28	Client User: administrator @ 10.3.42.146 logged out
22	2010/10/02 10:14:19	Client User: administrator @ 10.0.13.185 logged out
23	2010/10/02 10:14:50	Client User: administrator connected from 10.0.13.185

Log Information

The Log page displays events that take place on the KH1508Ai / KH1516Ai, and provides a breakdown of the time, the user, and a description of each one. You can change the sort order of the display by clicking on the column headings.

The log file tracks a maximum of 512 events. When the limit is reached, the oldest events get discarded as new events come in.

Chapter 11 Maintenance

Overview

The *Maintenance* function is used to upgrade firmware; backup and restore configuration and account information; and restore default values.

Browser GUI

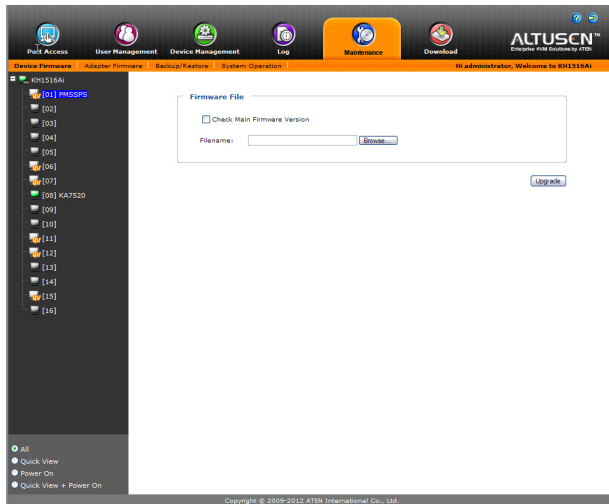

AP GUI

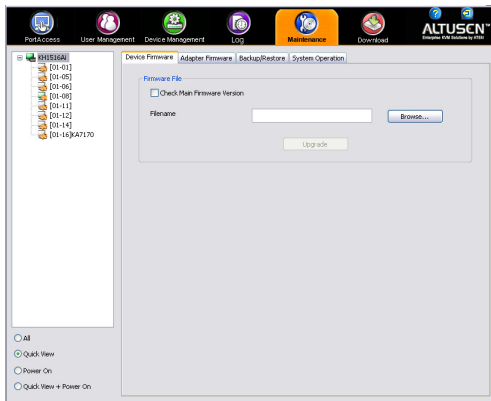

Device IP Card Firmware Upgrade

As new versions of the firmware become available, they can be downloaded from our website. Check the website regularly to find the latest information and packages.

To upgrade the device firmware, do the following:

1. Download the latest IP card firmware to your computer.
2. Log in to the KH1508Ai / KH1516Ai; and click the *Maintenance* tab. The Maintenance tab opens to the *Firmware File* page:

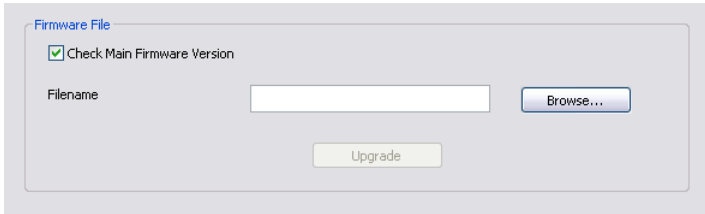

The screenshot shows a web interface for firmware management. At the top, the title is "Firmware File". Below the title, there is a checkbox labeled "Check Main Firmware Version" which is checked. Underneath the checkbox is a text input field labeled "Filename" and a "Browse..." button. At the bottom center of the form is an "Upgrade" button.

3. Click **Browse**; navigate to the directory that the new IP card firmware file is in and select the file.
4. Click **Upgrade Firmware** to start the upgrade procedure.
 - ◆ If you enabled *Check Main Firmware Version*, the current firmware version is compared with that of the upgrade file. If the current version is equal to or higher than the upgrade version, a popup message appears to inform and stops the upgrade procedure.
 - ◆ If you didn't enable *Check Main Firmware Version*, the upgrade file is installed without checking what its version is.
 - ◆ As the upgrade proceeds, progress information is shown in the *Progress bar*.
 - ◆ Once the upgrade completes successfully, the switch resets itself.
5. Log in again, and check the firmware version to be sure it is the new one.

Note: To recover from a “failed upgrade” situation, see *Device IP Card Firmware*, page 142.

Mainboard and KVM Adapter Cable Firmware Upgrade

The *Adapter Firmware* page is used to upgrade the firmware of the mainboard and KVM adapter cables.

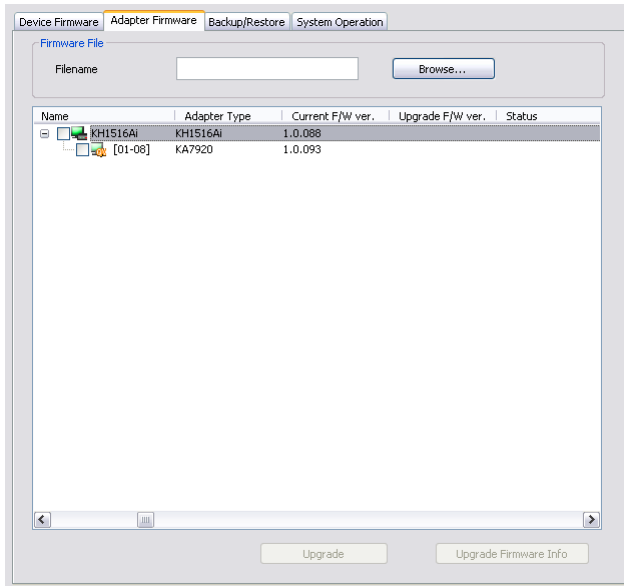

Mainboard Firmware Upgrade

To perform this upgrade, do the following:

1. Download the latest mainboard firmware package to your computer.
2. Log in to the KH1508Ai / KH1516Ai; and click the *Maintenance* tab; and select the *Adapter Firmware* menu item.
3. Click **Browse**; navigate to the directory that the new mainboard firmware package file is in and select the file.

Note: The mainboard firmware package contain software for device mainboards as well as KVM adapter cables.

4. The *Adapter Firmware* menu will now display a list of the mainboard firmware versions that are stored in the chosen file.

5. Compare the mainboard firmware version stored in the firmware package with the version listed in the *Current F/W Version* column of the Main Panel. If the version stored in the new firmware package are newer than the one on the mainboard, you will probably want to perform the upgrade.
6. In the *Name* column of the Main Panel, check the port whose device you want to upgrade. Here you can select whether to upgrade the firmware for just the mainboard (top checkbox), just the KVM adapter cables (bottom checkbox), or both.
7. Click **Upgrade** to start the upgrade procedure.
 - ◆ When the procedure completes the new adapter firmware version is displayed.

KVM Adapter Cable Firmware Upgrade

To perform this upgrade, do the following:

1. Download the latest mainboard firmware package to your computer.
2. Log in to the KH1508Ai / KH1516Ai; and click the *Maintenance* tab; and select the *Adapter Firmware* menu item.
3. Click **Browse**; navigate to the directory that the new mainboard firmware package file is in and select the file.

Note: The mainboard firmware package contain software for device mainboards as well as KVM adapter cables.

4. The *Adapter Firmware* menu will now display a list of the KVM adapter cable firmware versions that are stored in the chosen file.
5. Compare the adapter firmware version stored in the main firmware with the version listed in the *Current F/W Version* column of the Main Panel. If the version stored in the new firmware package are newer than the one on the adapter, you will probably want to perform the adapter upgrade.
6. In the *Name* column of the Main Panel, check the port whose device you want to upgrade. Here you can select whether to upgrade the firmware for just the mainboard (top checkbox), just the KVM adapter cables (bottom checkbox), or both.
7. Click **Upgrade** to start the upgrade procedure.
 - ◆ When the procedure completes the new adapter firmware version is displayed.

- Note:** 1. The switch may work with older adapter firmware versions, but for optimum compatibility we recommend upgrading your KVM adapter cable firmware to that stored in the switch's latest mainboard firmware package.
2. You can perform the upgrade procedure anytime you add an KVM adapter cable to the installation to make sure it is working with the latest firmware version.
3. To recover from a “failed upgrade” situation, see *Mainboard and KVM Adapter Cable Firmware*, page 142.
-

Firmware Upgrade Recovery

Device IP Card Firmware

Should the switch's main firmware upgrade procedure fail, and the switch becomes unusable, the following firmware upgrade recovery procedure will resolve the problem:

1. Power off the switch.
2. Press and hold the reset button in (see *reset button*, page 9).
3. While holding the reset button in, power the switch back on.

This causes the switch to use the original factory installed main firmware version. Once the switch is operational, you can try upgrading the main firmware again.

Mainboard and KVM Adapter Cable Firmware

Should the adapter firmware upgrade procedure fail for one of the KVM Adapter Cables and the adapter becomes unusable, the following adapter firmware upgrade recovery procedure will resolve the problem:

1. Unplug the Adapter from the server it is connected to.
2. Slide its *firmware upgrade recovery switch* (located next to the Cat 5e connector) to the **RECOVER** position.
3. Plug the Adapter back into the server.
4. Repeat the Adapter upgrade procedure.
5. After the Adapter has been successfully upgraded, unplug the Adapter from the server it is connected to; slide the Firmware Upgrade Recovery Switch back to the **NORMAL** position; and plug the Adapter back in.

Backup/Restore

Selecting the Backup/Restore menu item gives you the ability to back up the switch's configuration and user profile information:

Backup

To backup the device's settings do the following:

1. In the *Password* field, key in a password for the file.

Note: 1. Setting a password is optional. If you do not set one, the file can be restored without specifying a password.

2. If you do set a password, make a note of it, since you will need it to be able to restore the file.
-

2. Click **Backup**.
3. When the browser asks what you want to do with the file, select *Save to disk*; then save it in a convenient location.

System Operation

The *System Operation* page lets you restore certain configuration changes that were made to the KH1508Ai / KH1516Ai back to their original factory default values.

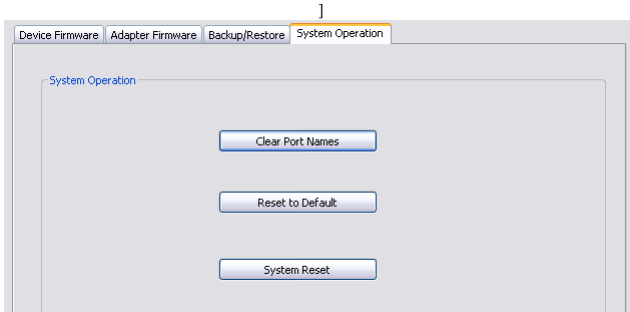

The functions performed on this page are as follows:

Clear Port Names:

Clicking this button removes names that have been assigned to the ports

Reset to Default:

Clicking this button undoes all Customization page changes that have been made to the KH1508Ai / KH1516Ai (except for the Port Names), as well as the Network Transfer Rate (on the Network page), and returns the parameters to the original factory default settings.

System Reset:

Clicking this button makes the KH1508Ai / KH1516Ai reset itself and implement all the new settings when you log out. (Following the reset, wait approximately 30 to 60 seconds before logging back in.)

Note: Even though the changed IP settings are ignored, they still remain in the network settings fields. Which means that the next time you open this page the *Reset on exit* checkbox will automatically be enabled, and when the switch resets, the new IP settings that you thought you discarded will become the ones used by the switch. To avoid this problem, you should go back to the network settings page and be sure that the IP settings that appear in the fields are the ones you want to use.

Chapter 12

Download

Overview

Download is used to download stand-alone AP versions of the Windows Client, the Java Client, the Log Server, and the PoN AP:



Click the program you want to download; save it to a convenient location on your hard disk, and run it from there.

This Page Intentionally Left Blank

Chapter 13

Port Operation

Overview

After you have successfully logged in (see *Logging In*, page 51), the KH1508Ai / KH1516Ai opens to the Port Access tab's Connections page, with the first KH1508Ai / KH1516Ai selected in the sidebar:

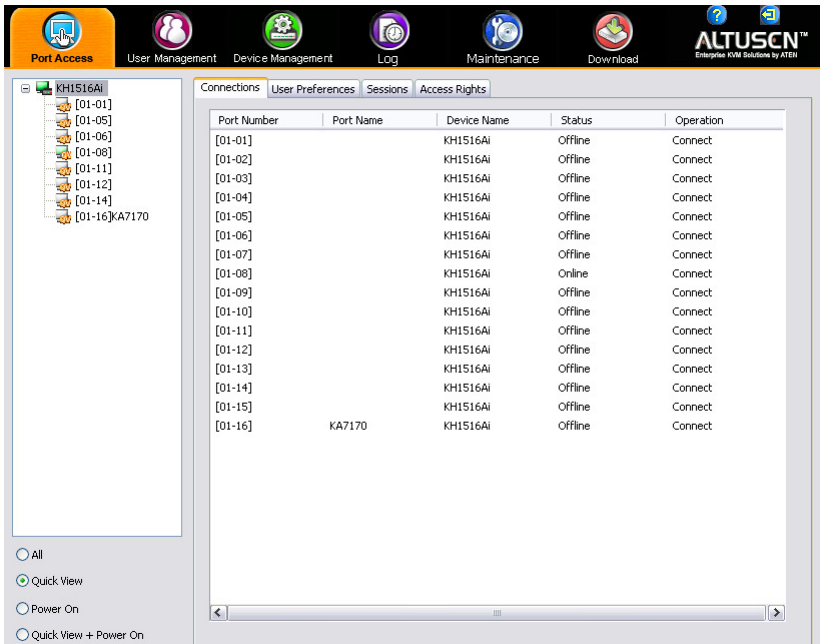

Note: See *Connections*, page 97 for details about the Port Access *Connections* page.

Connecting to a Port

All the devices, ports, and outlets that a user is permitted to access are listed in the Sidebar at the left of the page.

- ◆ To connect to a port when a device is selected in the Sidebar, double click its icon in the Sidebar; or double click anywhere on its line entry in the main central panel; or select it in the main panel and click **Connect** at the bottom right of the page.
- ◆ To connect to a port when the port is selected in the Sidebar, click **Connect** at the right of the *Status* panel (see page 97).

Once you switch to a port, its screen displays on your monitor, and your keyboard and mouse input affects the remote server:

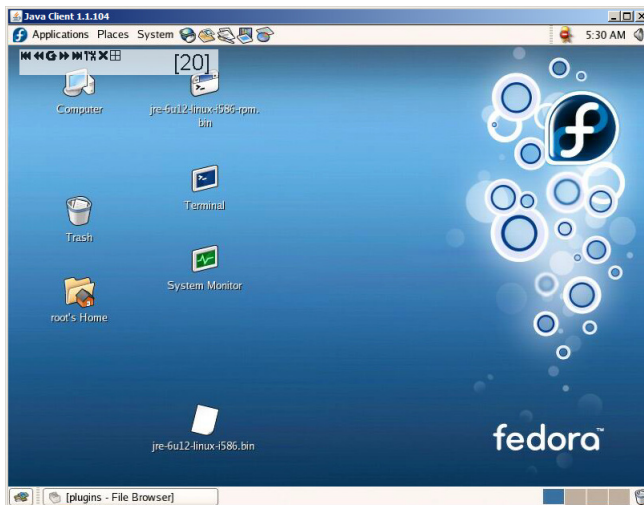

The Port Toolbar

The KH1508Ai / KH1516Ai interface provides a toolbar to help you with port switching operations from within the captured port. To bring up the toolbar, tap the GUI Hotkey (Scroll Lock or Ctrl), twice. The toolbar appears at the upper left corner of the screen:



Depending on the settings that were selected for ID Display (see page 99), the Port Number and/or the Port Name display at the right of the toolbar. The meanings of the toolbar icons are given in a table on page 150.











When the toolbar displays, mouse input is confined to the toolbar area and keyboard input has no effect on the server connected to the port. To carry out operations on the server, close the toolbar by clicking its X icon.

To return to the Port Access *Connections* page, either click the appropriate icon (see *The Toolbar Icons*, page 150), or tap the GUI hotkey again.

-
- Note:**
1. You can adjust the toolbar transparency (see *Video Settings*, page 79).
 2. The toolbar functions and icons are also incorporated in the Control Panel. If you choose to enable them in the Control Panel (see *Control Panel Configuration*, page 90), you can disable the Toolbar (see *User Preferences*, page 99 for details). To recall the Port Access *Connections* page when there is no Toolbar, simply tap the GUI hotkey twice.
-

The Toolbar Icons

The meanings of the toolbar icons are explained in the table below.

Icon	Purpose
	Click to switch to the previous station on the installation without having to recall the Port Access page.
	Click to switch to the next station on the installation without having to recall the Port Access page.
	Click to skip to the first accessible port on the entire installation, without having to recall the Port Access page.
	Click to skip to the first accessible port previous to the current one, without having to recall the Port Access page.
	Click to begin Auto Scan Mode. The KH1508Ai / KH1516Ai automatically switches among the ports that were selected for Auto Scanning. This allows you to monitor their activity without having to switch among them manually.
	Click to skip from the current port to the next accessible one, without having to recall the Port Access page.
	Click to skip from the current port to the last accessible port on the entire installation, without having to recall the Port Access page.
	Click to recall the Port Access page.
	Click to invoke Panel Array Mode (see <i>Panel Array Mode</i> , page 154).
	Click to close the toolbar.
	Click to logout and exit the application.

Toolbar Hotkey Port Switching

When the toolbar displays, you can use hotkeys to provide KVM focus to a port directly from the keyboard. The KH1508Ai / KH1516Ai provides the following hotkey features:

- ◆ Going directly to a port by keying in its port number and clicking **Enter**.
- ◆ Auto Scanning
- ◆ Skip Mode Switching

The hotkeys are: **A** and **P** for Auto Scanning; and the **Arrow Keys** for Skip Mode.

-
- Note:**
1. In order for hotkey operations to take place, the toolbar must be visible (see *The Port Toolbar*, page 149).
 2. To use the keys designated as hotkeys (i.e. A, P, etc.) for normal, non-hotkey purposes, you must first close the toolbar.
 3. For issues affecting multiple user operation in Auto Scan Mode, see *Multiuser Operation*, page 156.
-

Auto Scanning

The Scan function automatically switches among all the ports that are accessible to the currently logged on user at regular intervals, so that the user can monitor their activity automatically.

- ◆ Setting the Scan Interval:

The amount of time Auto Scan dwells on each port is set with the *Scan Duration* setting (see *Scan Duration*, page 100).

- ◆ Invoking Auto Scan

To start Auto Scanning, with the toolbar showing, tap the **A** key. The Auto Scan function cycles through the ports in order – starting from the first port on the installation. An **S** appears in front of the Port ID Display to indicate that the port is being accessed under Auto Scan Mode.

- ◆ Pausing Auto Scan

While you are in Auto Scan Mode, you can pause the scanning in order to keep the focus on a particular server by pressing **P**. During the time that Auto Scanning is paused, the **S** in front of the Port ID blinks On and Off.

Pausing when you want to keep the focus on a particular server can be more convenient than exiting Auto Scan Mode because when you *Resume* scanning, you start from where you left off. If, on the other hand, you were to exit and then restart Auto Scan Mode, the scanning would start over from the very first server on the installation.

To *Resume* Auto Scanning after a pause, press any key except [Esc] or the [Spacebar]. Scanning continues from where it left off.

- ◆ Exiting Auto Scan

While Auto Scan Mode is in effect, ordinary keyboard functions are suspended. You must exit Auto Scan Mode in order to regain normal control of the keyboard. To exit Auto Scan Mode press [Esc] or the [Spacebar]. Auto Scanning stops when you exit Auto Scan Mode.

Skip Mode

Skip Mode allows you to switch ports in order to monitor the servers manually. You can dwell on a particular port for as long or as little as you like - as opposed to Auto Scanning, which automatically switches after a fixed interval. The Skip Mode hotkeys are the four Arrow keys. Their operation is explained in the table below:

Arrow	Action
←	Skips from the current port to the first accessible port previous to it.
→	Skips from the current port to the first accessible port that comes after it.
↑	Skips from the current port to the first accessible port on the installation.
↓	Skips from the current port to the last accessible port on the installation.

Recalling the Port Access Page

To dismiss the toolbar and bring back the Port Access page, do one of the following:

- ◆ Tap the GUI Hotkey once.
- ◆ From the toolbar, click the icon that recalls the Port Access page (see *The Toolbar Icons*, page 150).

The toolbar closes, and the Port Access Page appears.

GUI Hotkey Summary Table

The following table presents a summary of the GUI Hotkey actions after you have accessed a port. See *User Preferences*, page 99 to set the GUI Hotkey.

To...		Do This...
Open the Toolbar		Click the GUI Hotkey twice
Open the Port Access Page	The Toolbar is open	Click the GUI Hotkey once
	The Toolbar is not open	Click the GUI Hotkey three times

Panel Array Mode



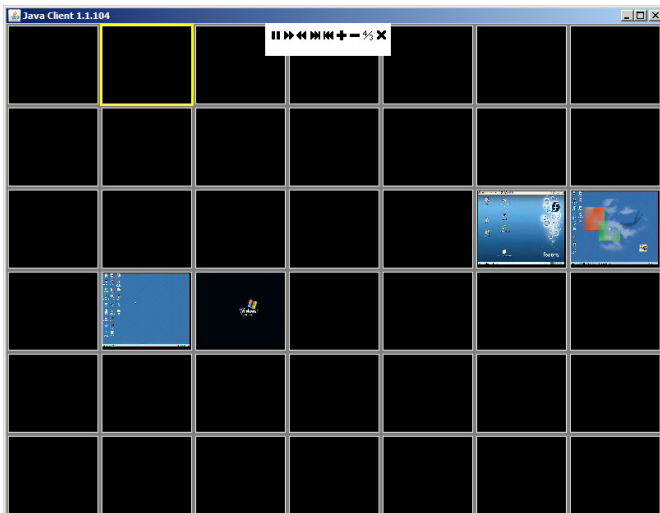







Clicking the toolbar's *Panel* icon invokes Panel Array Mode. Under this mode, the screen divides into a grid of panels:



- ◆ Each panel represents one of the switch's ports beginning with Port 1 at the upper left, and going from left to right; top to bottom.
- ◆ The number of panels in the array can be selected by clicking the **Show More Ports**, and **Show Fewer Ports** symbols on the panel array toolbar (see the following page for an explanation of the panel array toolbar).
- ◆ Only ports that are accessible to the user are displayed. For ports that are not accessible, the panel is blank.
- ◆ If the server connected to a port is on line, its screen displays in its panel, otherwise the panel is blank.
- ◆ Mousing over a panel displays information about the port (port name, online status, port access status, and resolution).
- ◆ You can access a server connected to a port by moving the mouse pointer over its panel and clicking. You switch to the server exactly as if you had selected it from the Port Access page.

Panel Array Toolbar

The panel array toolbar provides shortcut navigation and control of the panel array. The toolbar can be dragged anywhere on the screen. Mousing over an icon brings up a “tooltip” that provides a short description of the icon’s function. The icon functions are described in the table below:

	Click and drag to move the toolbar. Note: This icon is only available with the Windows Clients. To move the Java Client toolbars, click on any empty space and drag.
	Pause panel scanning, leaving the focus on the panel that currently has it.
	Move back four panels.
	Move to the previous panel.
	Move to the next panel.
	Move ahead four panels.
	Show More Ports: Increase the number of panels in the array.
	Show Fewer Ports: Decrease the number of panels in the array.
	Toggle 4/3 aspect ratio.
	Exit Panel Array mode.

Note: For issues affecting multiple user operation in Panel Array Mode, see *Multiuser Operation*, page 156.

Multuser Operation

The KH1508Ai / KH1516Ai supports multuser operation. When multiple users simultaneously access the switch from client computers, the rules of precedence that apply are shown in the following table:

Operation	Rule
General	The switches utilize a single shared bus implementation – although they support local and remote login at the same time, they do not support independent operation. If a local user logs in while a remote user has already opened a session, the local user sees the same screen that the remote user is working on
Auto Scan Mode	<p>If a user has invoked Auto Scan Mode (see page 151), and then another user logs on, at first the new user sees the GUI Main Page – but as soon as he accesses any port, he automatically enters Auto Scan Mode (since he is sharing the bus with the original user).</p> <p>Any user can halt Auto Scan Mode by recalling the GUI Main Page. When this occurs, Auto Scan Mode stops and all the other users on the bus are switched to the port that was being accessed when Auto Scan Mode stopped.</p>
Panel Array Mode	<ul style="list-style-type: none"> ◆ If a user has invoked Panel Array Mode (see page 154), and then another user logs on, the new user sees the GUI Main Page – but as soon as he accesses any port, he automatically enters Panel Array Mode (since he is sharing the bus with the original user). ◆ Panel Array Mode continues until the original user stops it. (Administrators can override Panel Array Mode, however.) ◆ Only the user who starts Panel Array Mode can use the Skip Mode (see page 152), function. ◆ Only the user who starts Panel Array Mode can switch ports. Other users automatically switch to the ports that the original user selects. However, if one of the other users does not have access rights to the port that the original user switches to, that user will not be able to view the port. ◆ Individual users can increase or decrease the number of panels they wish to view in Panel Array Mode; however, the picture quality may decrease as the number of panels increases.

Chapter 14

The Log Server

The Windows-based Log Server is an administrative utility that records all the events that take place on selected KH1508Ai / KH1516Ai units and writes them to a searchable database. This chapter describes how to install and configure the Log Server.

Installation

1. Log into the KH1508Ai / KH1516Ai (see page 51).
2. Click the *Download* tab and download the Log Server AP program.
3. Go to the location on your hard disk that you downloaded the Log Server program to, and double click its icon (*LogSetup.exe*) to bring up the Windows Client Connection Screen:

Note: If the browser cannot run the file, save it to disk, instead, and run the file from your disk.

The Log Server installation screen appears:

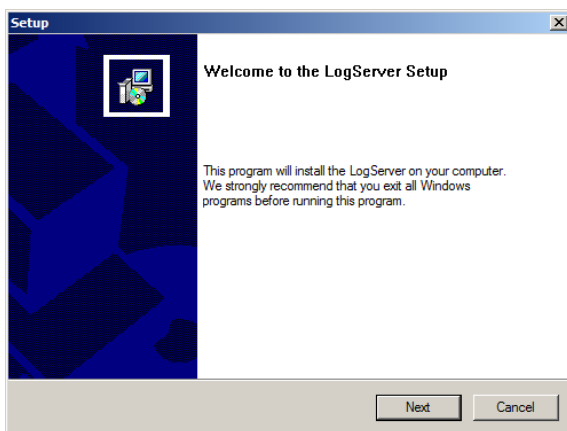

4. Click **Next**. Then follow the on-screen instructions to complete the installation and have the Log Server program icon placed on your desktop.

Starting Up

To start the Log Server, either double click the program icon, or key in the full path to the program on the command line. The first time you run it, a screen similar to the one below appears:

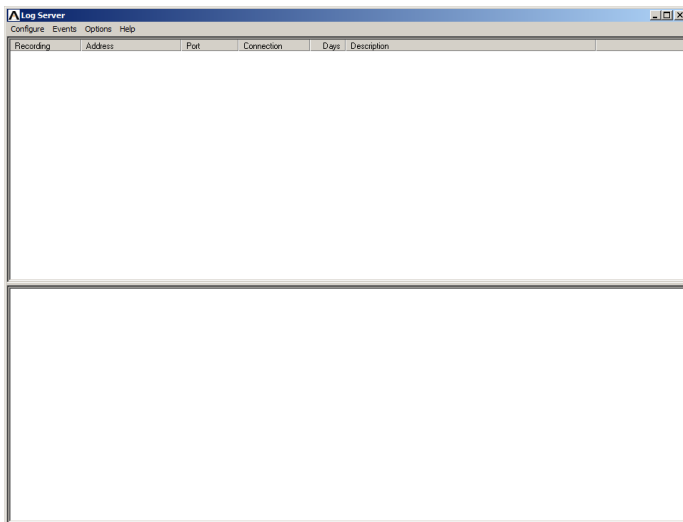

-
- Note:** 1. The MAC address of the Log Server computer must be specified in the ANMS settings – see *Log Server*, page 119.
2. The Log Server requires the Microsoft Jet OLEDB 4.0 driver. See *The Log Server program does not run.*, page 175 if the program doesn't start.
-

The screen is divided into three components:

- ◆ A *Menu Bar* at the top
- ◆ A panel that will contain a list of KH1508Ai / KH1516Ai in the middle (see *The Log Server Main Screen*, page 163).
- ◆ A panel that will contain an *Events List* at the bottom

Each of the components is explained in the sections that follow.

The Menu Bar

The Menu bar consists of four items:

- ◆ Configure
- ◆ Events
- ◆ Options
- ◆ Help

These are discussed in the sections that follow.

Note: If the Menu Bar appears to be disabled, click in the List window to enable it.

Configure

The Configure menu contains three items: Add; Edit; and Delete. They are used to add new units to the List; edit the information for units already on the list; or delete units from the list.

- ◆ To add a unit to the list, click **Add**.
- ◆ To edit or delete a listed unit, first select the target in the List window, then open this menu and click **Edit** or **Delete**.

When you choose *Add* or *Edit*, a dialog box, similar to the one below, appears:

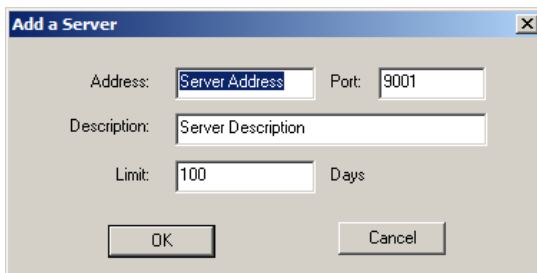

The screenshot shows a dialog box titled "Add a Server". It has a standard Windows-style title bar with a close button (X) in the top right corner. The dialog contains the following fields and controls:

- Address:** A text input field containing "Server Address".
- Port:** A text input field containing "9001".
- Description:** A larger text input field containing "Server Description".
- Limit:** A text input field containing "100", followed by the label "Days".
- Buttons:** Two buttons at the bottom: "OK" on the left and "Cancel" on the right.

A description of the fields is given in the table, below:

Field	Explanation
Address	This can either be the IP address of the computer the Log Server is running on, or its DNS name.
Port	The port number that was assigned to the Log Server under <i>Device Management</i> (see <i>Log Server</i> , page 119).
Description	This field is provided so that you can put in a descriptive reference for the unit to help identify it.
Limit	This specifies the number of days that an event should be kept in the Log Server's database. Events that exceed the amount of time specified here can be removed with the Maintenance function (see <i>Maintenance.</i> , page 161).

Fill in or modify the fields, then click **OK** to finish.

Events

The Events Menu has two items: *Search* and *Maintenance*.

Search:

Search allows you to search for events containing specific words or strings. When you access this function, a screen, similar to the one below, appears:

The screenshot shows a 'Search Dialog' window with the following elements:

- Search Options:** Three radio buttons: 'New search' (selected), 'Search last results', and 'Search excluding last results'.
- Server List:** A text box containing '10.0.13.233'.
- Priority List:** A text box containing 'Least', 'Less', and 'Most'.
- Search Criteria:** Fields for 'Start date' (2009/11/16), 'Start time' (13:55:19), 'End date' (2009/11/17), 'End time' (13:55:19), and 'Pattern' (empty).
- Result:** A text area displaying search results for 'Server: 10.0.13.233'. The results include:
 - 2009/11/16 15:13:27 : User administrator changes to [03] 9120 CN8 to .14.
 - 2009/11/17 13:49:06 : User administrator from 00-19-DB-EA-8C-C5 10.0.13.178 attempting to login.
 - 2009/11/17 13:51:02 : User at 00-19-DB-EA-8C-C5 10.0.13.178 logged out
 - 2009/11/17 13:51:48 : Sys: Connected to 10.0.13.178 (00-19-DB-EA-8C-C5)
 - 2009/11/17 13:51:49 : User administrator (IP = 10.0.13.178) attempting to login.
 - 2009/11/17 13:51:49 : Sys: Access via Java client (IP = 10.0.13.178).
 - 2009/11/17 13:51:56 : Sys: Disconnected from 10.0.13.178 (00-19-DB-EA-8C-C5)
 - 2009/11/17 13:51:56 : User (IP = 10.0.13.178) logged out.
 - 2009/11/17 13:52:21 : Sys: Connected to 10.0.13.178 (00-19-DB-EA-8C-C5)
 - 2009/11/17 13:52:22 : User administrator (IP = 10.0.13.178) attempting to login.
- Buttons:** 'Search', 'Print', 'Export', and 'Exit'.

A description of the items is given in the table, below:

Item	Description
New search	This is one of three radio buttons that define the scope of the search. If it is selected, the search is performed on all the events in the database for the selected unit.
Search last results	This is a secondary search performed on the events that resulted from the previous search.
Search excluding last results	This is a secondary search performed on all the events in the database for the selected unit excluding the events that resulted from the previous search.
Server List	KH1508Ai / KH1516Ai units are listed according to their IP address. Select the unit that you want to perform the search on from this list. You can select more than one unit for the search. If no units are selected, the search is performed on all of them.
Priority	Sets the level for how detailed the search results display should be. <i>Least</i> is the most general; <i>Most</i> is the most specific. Least results appear in black; Less results appear in blue; Most results appear in red.
Start Date	Select the date that you want the search to start from. The format follows the YYYY/MM/DD convention, as follows: 2009/11/04
Start Time	Select the time that you want the search to start from. The format follows the HH:MM:SS convention.
End Date	Select the date that you want the search to end at.
End Time	Select the time that you want the search to end at.
Pattern	Key in the pattern that you are searching for here. The multiple character wildcard (%) is supported. E.g., h%ds would match hands and hoods.
Results	Lists the events that contained matches for the search.
Search	Click this button to start the search.
Print	Click this button to print the search results.
Export	Click this button to save the search results to file.
Exit	Click this button to exit the Log Server.

Maintenance:

This function allows the administrator to perform manual maintenance of the database, such as erasing specified records before their expiration time is up.

Options

Network Retry allows you to set the number of seconds that the Log Server should wait before attempting to connect if its previous attempt to connect failed. When you click this item, a dialog box, similar to the one below, appears:

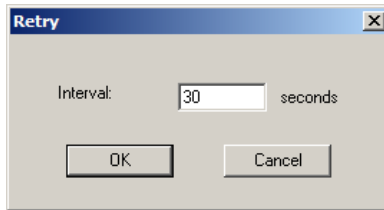

Key in the number of seconds, then click **OK** to finish.

Help

From the Help menu, click Contents to access the online Windows Help file. The help file contains instructions about how to setup, operation and troubleshoot the Log Server.

The Log Server Main Screen

Overview

The Log Server Main Screen is divided into two main panels.

- ◆ The upper (List) panel lists all of the units that have been selected for the Log Server to track (see *Configure*, page 159).
- ◆ The lower (Event) panel displays the tick information for the currently selected unit. (If there are more than one unit, the selected unit is the one that is highlighted).
- ◆ To select a unit in the list, simply click on it.

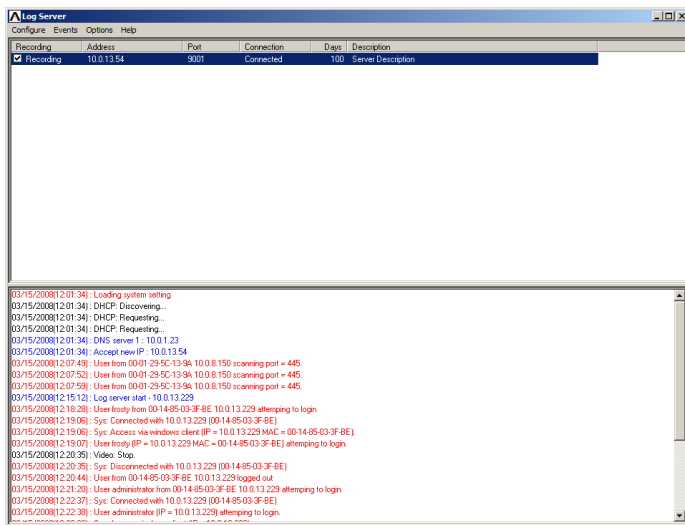

The List Panel

The List panel contains six fields:

Field	Explanation
Recording	Determines whether the Log Server records the ticks for this unit, or not. If the Recording checkbox is checked, the field displays <i>Recording</i> , and the ticks are recorded. If the Recording checkbox is not checked, the field displays <i>Paused</i> , and the ticks are not recorded. Note: Even though a unit is not the currently selected one, if its Recording checkbox is checked, the Log Server will still record its ticks.
Address	This is the IP Address or DNS name that was given to the unit when it was added to the Log Server (see <i>Configure</i> , page 159).
Port	This is the Access Port number assigned to the unit (see <i>Configure</i> , page 159).
Connection	<ul style="list-style-type: none">◆ If the Log Server is connected to the unit, this field displays <i>Connected</i>.◆ If the Log Server is not connected, this field displays <i>Waiting</i>. This means that the Log Server's MAC address has not been set properly. It needs to be set on the <i>Device Management Date/Time</i> page (see page 132).
Days	This field displays the number of days that the unit's log events are to be kept in the Log Server's database before expiration (see <i>Configure</i> , page 159).
Description	This field displays the descriptive information given for the unit when it was added to the Log Server (see <i>Configure</i> , page 159).

The Event Panel

The lower panel displays log events for the currently selected unit. Note that if there are more than one units, even though they aren't currently selected, if their *Recording* checkbox is checked, the Log Server records their log events and keeps them in its database.

Safety Instructions

General

- ◆ This product is for indoor use only.
- ◆ Read all of these instructions. Save them for future reference.
- ◆ Follow all warnings and instructions marked on the device.
- ◆ Do not place the device on any unstable surface (cart, stand, table, etc.). If the device falls, serious damage will result.
- ◆ Do not use the device near water.
- ◆ Do not place the device near, or over, radiators or heat registers.
- ◆ The device cabinet is provided with slots and openings to allow for adequate ventilation. To ensure reliable operation, and to protect against overheating, these openings must never be blocked or covered.
- ◆ The device should never be placed on a soft surface (bed, sofa, rug, etc.) as this will block its ventilation openings. Likewise, the device should not be placed in a built in enclosure unless adequate ventilation has been provided.
- ◆ Never spill liquid of any kind on the device.
- ◆ Unplug the device from the wall outlet before cleaning. Do not use liquid or aerosol cleaners. Use a damp cloth for cleaning.
- ◆ The device should be operated from the type of power source indicated on the marking label. If you are not sure of the type of power available, consult your dealer or local power company.
- ◆ The device is designed for IT power distribution systems with 230V phase-to-phase voltage.
- ◆ To prevent damage to your installation it is important that all devices are properly grounded.
- ◆ The device is equipped with a 3-wire grounding type plug. This is a safety feature. If you are unable to insert the plug into the outlet, contact your electrician to replace your obsolete outlet. Do not attempt to defeat the purpose of the grounding-type plug. Always follow your local/national wiring codes.
- ◆ Do not allow anything to rest on the power cord or cables. Route the power cord and cables so that they cannot be stepped on or tripped over.

- ◆ If an extension cord is used with this device make sure that the total of the ampere ratings of all products used on this cord does not exceed the extension cord ampere rating. Make sure that the total of all products plugged into the wall outlet does not exceed 15 amperes.
- ◆ To help protect your system from sudden, transient increases and decreases in electrical power, use a surge suppressor, line conditioner, or uninterruptible power supply (UPS).
- ◆ Position system cables and power cables carefully; Be sure that nothing rests on any cables.
- ◆ Never push objects of any kind into or through cabinet slots. They may touch dangerous voltage points or short out parts resulting in a risk of fire or electrical shock.
- ◆ Do not attempt to service the device yourself. Refer all servicing to qualified service personnel.
- ◆ If the following conditions occur, unplug the device from the wall outlet and bring it to qualified service personnel for repair.
 - ◆ The power cord or plug has become damaged or frayed.
 - ◆ Liquid has been spilled into the device.
 - ◆ The device has been exposed to rain or water.
 - ◆ The device has been dropped, or the cabinet has been damaged.
 - ◆ The device exhibits a distinct change in performance, indicating a need for service.
 - ◆ The device does not operate normally when the operating instructions are followed.
- ◆ Only adjust those controls that are covered in the operating instructions. Improper adjustment of other controls may result in damage that will require extensive work by a qualified technician to repair.
- ◆ Do not connect the RJ-11 connector marked “UPGRADE” to a public telecommunication network.

Rack Mounting

- ◆ Before working on the rack, make sure that the stabilizers are secured to the rack, extended to the floor, and that the full weight of the rack rests on the floor. Install front and side stabilizers on a single rack or front stabilizers for joined multiple racks before working on the rack.
- ◆ Always load the rack from the bottom up, and load the heaviest item in the rack first.
- ◆ Make sure that the rack is level and stable before extending a device from the rack.
- ◆ Use caution when pressing the device rail release latches and sliding a device into or out of a rack; the slide rails can pinch your fingers.
- ◆ After a device is inserted into the rack, carefully extend the rail into a locking position, and then slide the device into the rack.
- ◆ Do not overload the AC supply branch circuit that provides power to the rack. The total rack load should not exceed 80 percent of the branch circuit rating.
- ◆ Make sure that all equipment used on the rack – including power strips and other electrical connectors – is properly grounded.
- ◆ Ensure that proper airflow is provided to devices in the rack.
- ◆ Ensure that the operating ambient temperature of the rack environment does not exceed the maximum ambient temperature specified for the equipment by the manufacturer
- ◆ Do not step on or stand on any device when servicing other devices in a rack.

Consignes de sécurité

Général

- ♦ Ce produit est destiné exclusivement à une utilisation à l'intérieur.
- ♦ Veuillez lire la totalité de ces instructions. Conservez-les afin de pouvoir vous y référer ultérieurement.
- ♦ Respectez l'ensemble des avertissements et instructions inscrits sur l'appareil.
- ♦ Ne placez jamais l'unité sur une surface instable (chariot, pied, table, etc.). Si l'unité venait à tomber, elle serait gravement endommagée.
- ♦ N'utilisez pas l'unité à proximité de l'eau.
- ♦ Ne placez pas l'unité à proximité de ou sur des radiateurs ou bouches de chaleur.
- ♦ Le boîtier de l'unité est doté de fentes et d'ouvertures destinées à assurer une ventilation adéquate. Pour garantir un fonctionnement fiable et protéger l'unité contre les surchauffes, ces ouvertures ne doivent jamais être bloquées ou couvertes.
- ♦ L'unité ne doit jamais être placée sur une surface molle (lit, canapé, tapis, etc.) car ses ouvertures de ventilation se trouveraient bloquées. De même, l'unité ne doit pas être placée dans un meuble fermé à moins qu'une ventilation adaptée ne soit assurée.
- ♦ Ne renversez jamais de liquides de quelque sorte que ce soit sur l'unité.
- ♦ Débranchez l'unité de la prise murale avant de la nettoyer. N'utilisez pas de produits de nettoyage liquide ou sous forme d'aérosol. Utilisez un chiffon humide pour le nettoyage de l'unité.
- ♦ L'appareil doit être alimenté par le type de source indiqué sur l'étiquette. Si vous n'êtes pas sûr du type d'alimentation disponible, consultez votre revendeur ou le fournisseur local d'électricité.
- ♦ Afin de ne pas endommager votre installation, vérifiez que tous les périphériques sont correctement mis à la terre.
- ♦ L'unité est équipée d'une fiche de terre à trois fils. Il s'agit d'une fonction de sécurité. Si vous ne parvenez pas à insérer la fiche dans la prise murale, contactez votre électricité afin qu'il remplace cette dernière qui doit être obsolète. N'essayez pas d'aller à l'encontre de l'objectif de la fiche de terre. Respectez toujours les codes de câblage en vigueur dans votre région/pays.

-
- ◆ L'équipement doit être installé à proximité de la prise murale et le dispositif de déconnexion (prise de courant femelle) doit être facile d'accès.
 - ◆ La prise murale doit être installée à proximité de l'équipement et doit être facile d'accès.
 - ◆ Veillez à ce que rien ne repose sur le cordon d'alimentation ou les câbles. Acheminez le cordon d'alimentation et les câbles de sorte que personne ne puisse marcher ou trébucher dessus.
 - ◆ En cas d'utilisation d'une rallonge avec cette unité, assurez-vous que le total des ampérages de tous les produits utilisés sur cette rallonge ne dépasse pas l'ampérage nominal de cette dernière. Assurez-vous que le total des ampérages de tous les produits branchés sur la prise murale ne dépasse pas 15 ampères.
 - ◆ Pour contribuer à protéger votre système contre les augmentations et diminutions soudaines et transitoires de puissance électrique, utilisez un parasurtenseur, un filtre de ligne ou un système d'alimentation sans coupure (UPS).
 - ◆ Placez les câbles du système et les câbles d'alimentation avec précaution ; veillez à ce que rien ne repose sur aucun des câbles.
 - ◆ Lors du branchement ou du débranchement à des blocs d'alimentation permettant la connexion à chaud, veuillez respecter les lignes directrices suivantes:
 - ◆ Installez le bloc d'alimentation avant de brancher le câble d'alimentation à celui-ci.
 - ◆ Débranchez le câble d'alimentation avant de retirer le bloc d'alimentation.
 - ◆ Si le système présente plusieurs sources d'alimentation, déconnectez le système de l'alimentation en débranchant tous les câbles d'alimentation des blocs d'alimentation.
 - ◆ N'insérez jamais d'objets de quelque sorte que ce soit dans ou à travers les fentes du boîtier. Ils pourraient entrer en contact avec des points de tension dangereuse ou court-circuiter des pièces, entraînant ainsi un risque d'incendie ou de choc électrique.
 - ◆ N'essayez pas de réparer l'unité vous-même. Confiez toute opération de réparation à du personnel qualifié.
 - ◆ Si les conditions suivantes se produisent, débranchez l'unité de la prise murale et amenez-la à un technicien qualifié pour la faire réparer:
 - ◆ Le cordon d'alimentation ou la fiche ont été endommagés ou éraillés.
 - ◆ Du liquide a été renversé dans l'unité.
-

- ◆ L'unité a été exposée à la pluie ou à l'eau.
- ◆ L'unité est tombée ou le boîtier a été endommagé.
- ◆ Les performances de l'unité sont visiblement altérées, ce qui indique la nécessité d'une réparation.
- ◆ L'unité ne fonctionne pas normalement bien que les instructions d'utilisation soient respectées.
- ◆ N'utilisez que les commandes qui sont abordées dans le mode d'emploi. Le réglage incorrect d'autres commandes peut être à l'origine de dommages qui nécessiteront beaucoup de travail pour qu'un technicien qualifié puisse réparer l'unité.
- ◆ Ne connectez pas le connecteur RJ-11 portant la marque « Sensor » (Capteur) à un réseau de télécommunication public.

Montage sur bâti

- ◆ Avant de travailler sur le bâti, assurez-vous que les stabilisateurs sont bien fixés sur le bâti, qu'ils sont étendus au sol et que tout le poids du bâti repose sur le sol. Installez les stabilisateurs avant et latéraux sur un même bâti ou bien les stabilisateurs avant si plusieurs bâtis sont réunis, avant de travailler sur le bâti.
- ◆ Chargez toujours le bâti de bas en haut et chargez l'élément le plus lourd en premier.
- ◆ Assurez-vous que le bâti est à niveau et qu'il est stable avant de sortir une unité du bâti.
- ◆ Agissez avec précaution lorsque vous appuyez sur les loquets de libération du rail d'unité et lorsque vous faites coulisser une unité dans et hors d'un bâti ; vous pourriez vous pincer les doigts dans les rails.
- ◆ Une fois qu'une unité a été insérée dans le bâti, étendez avec précaution le rail dans une position de verrouillage puis faites glisser l'unité dans le bâti.
- ◆ Ne surchargez pas le circuit de l'alimentation CA qui alimente le bâti. La charge totale du bâti ne doit pas dépasser 80 % de la capacité du circuit.
- ◆ Assurez-vous que tous les équipements utilisés sur le bâti, y-compris les multiprises et autres connecteurs électriques, sont correctement mis à la terre.
- ◆ Assurez-vous que les unités présentes dans le bâti bénéficie d'une circulation d'air suffisante.
- ◆ Assurez-vous que la température ambiante de fonctionnement de l'environnement du bâti ne dépasse pas la température ambiante maximale spécifiée pour l'équipement par le fabricant.
- ◆ Ne marchez sur aucun appareil lors de la maintenance d'autres appareils d'un bâti.

Technical Support

International

- ◆ For online technical support – including troubleshooting, documentation, and software updates: **<http://eservice.aten.com>**
- ◆ For telephone support, see *Telephone Support*, page v.

North America

Email Support		support@aten-usa.com
Online Technical Support	Troubleshooting Documentation Software Updates	http://eservice.aten.com
Telephone Support		1-888-999-ATEN ext 4988

When you contact us, please have the following information ready beforehand:

- ◆ Product model number, serial number, and date of purchase.
- ◆ Your computer configuration, including operating system, revision level, expansion cards, and software.
- ◆ Any error messages displayed at the time the error occurred.
- ◆ The sequence of operations that led up to the error.
- ◆ Any other information you feel may be of help.

Troubleshooting

Administration

Problem	Resolution
After upgrading firmware, the KH1508Ai / KH1516Ai still appears to be using the old firmware version.	Your Internet browser is displaying cached web pages – not new ones. Clear your browser cache; delete all temporary Internet files and cookies, close the Internet browser, and then open a new instance of the browser.
The default network setting for the KH1508Ai / KH1516Ai is DHCP, but the network uses fixed IP addresses and doesn't have a DHCP server.	Use the local console OSD's F4 function to give the KH1508Ai / KH1516Ai a fixed IP address. See page 35, for details.

General Operation

Problem	Resolution
Erratic Operation	Press and hold the Reset Switch (see page 9) for longer than three seconds.
Mouse and/or keyboard not responding due to improper mouse and/or keyboard reset.	Unplug the cable(s) from the console port(s), then plug it back in again.
Sudden loss of network connection due to local reset of KH1508Ai / KH1516Ai.	Close your KH1508Ai / KH1516Ai connection. Wait approximately 30 seconds, and log in again.
Mouse Pointer Confusion	If you find the display of two mouse pointers (local and remote) to be confusing or annoying, you can use the <i>Toggle Mouse Display</i> function to shrink the non-functioning pointer. See page 85 for details.
Some characters that are keyed in don't display on the remote system	This is usually due to the local OS keyboard language and the remote OS keyboard language being different. Make sure that the keyboard language for both systems are the same.
Video is a little blurred, or a little overly sharp.	Change the Cat5e/6 cable length setting. See page 36.

The Windows Client

Problem	Resolution
won't connect to the KH1508Ai / KH1516Ai.	DirectX 8.0 or higher must be installed on your computer.
Remote mouse pointer is out of sync.	<ol style="list-style-type: none"> 1. Use the <i>AutoSync</i> feature (see <i>Video Settings</i>, page 89), to sync the local and remote monitors. 2. If that doesn't resolve the problem, use the <i>Adjust Mouse</i> feature (see <i>Mouse Synchronization</i>, page 110) to bring them back in sync. 3. If the two methods described above fail to resolve the problem, use the <i>Toggle Mouse Display</i> function (see page 85).
Part of remote window is off my monitor.	Use the <i>AutoSync</i> feature (see <i>Video Settings</i> , page 89) to synchronize the local and remote monitors.
My antivirus program reports that there is a trojan after I access the KH1508Ai / KH1516Ai with my browser and then open the Windows Client Viewer.	The Windows Client Viewer uses an ActiveX plugin (windows.ocx) that some antivirus programs mistakenly see as a virus or trojan. We have tested our firmware extensively and found no evidence of a virus or trojan. You can add the plugin to your antivirus program's White List and use the Viewer safely. If you are reluctant to use the Windows Client Viewer, however, you can simply use the Java Client Viewer, instead.

The Java Client

For connection and operation problems, see the table below:

Problem	Resolution
Java Client won't connect to the KH1508Ai / KH1516Ai.	<ol style="list-style-type: none"> 1. Java JRE 6 update 3 or higher must be installed on your computer. 2. Make sure to include the correct name of the web page when you specify the KH1508Ai / KH1516Ai's IP address. 3. Close the Java Client, reopen it, and try again.
Pressing the Windows Menu key has no effect.	Java doesn't support the Windows Menu key.
Java Client performance deteriorates.	Exit the program and start again.
National language characters do not appear.	When entering national language characters, if your local keyboard is set to a non-English national language layout, you must set the remote computer's keyboard layout to English.

The Log Server

Problem	Resolution
The Log Server program does not run.	<p>The Log Server requires the Microsoft Jet OLEDB 4.0 driver in order to access the database.</p> <p>This driver is automatically installed with Windows ME, 2000, and XP.</p> <p>For Windows 98 and NT you will have to go to the Microsoft download site:</p> <p style="padding-left: 40px;">http://www.microsoft.com/data/download.htm</p> <p>to retrieve the driver file:</p> <p style="padding-left: 40px;"><i>MDAC 2.7 RTM Refresh (2.70.9001.0)</i></p> <p>Since this driver is used in Windows Office Suite, an alternate method of obtaining it is to install Windows Office Suite. Once the driver file or Suite has been installed, the Log Server will run.</p>

Panel Array Mode

Problem	Resolution
Low resolution video in Panel Array Mode.	Increase the number of panels that are displayed.
Some users only receive a partial image when multiple remote users are logged in concurrently.	The first user to invoke Panel Array Mode should set it to display a minimum of four panels.

Sun Systems

Problem	Resolution
Video display problems with HDB-15 interface systems (e.g. Sun Blade 1000 servers).	<p>The display resolution should be set to 1024 x 768.</p> <p>Under Text Mode:</p> <ol style="list-style-type: none"> Go to OK mode and issue the following commands: <pre>setenv output-device screen:r1024x768x60 reset-all</pre> <p>Under XWindow:</p> <ol style="list-style-type: none"> Open a console and issue the following command: <pre>m64config -res 1024x768x60</pre> Log out. Log in.
Video display problems with 13W3 interface systems (e.g. Sun Ultra servers).*	<p>The display resolution should be set to 1024 x 768.</p> <p>Under Text Mode:</p> <ol style="list-style-type: none"> Go to OK mode and issue the following commands: <pre>setenv output-device screen:r1024x768x60 reset-all</pre> <p>Under XWindow:</p> <ol style="list-style-type: none"> Open a console and issue the following command: <pre>ffbconfig -res 1024x768x60</pre> Log out. Log in.

* These solutions work for most common Sun VGA cards. If using them fails to resolve the problem, consult the Sun VGA card's manual.

Additional Mouse Synchronization Procedures

If the mouse synchronization procedures mentioned in the manual fail to resolve mouse pointer problems for particular computers, try the following:

-
- Note:** 1. These procedures are to be performed on the computers attached to the KH1508Ai / KH1516Ai's ports - not on the computer you are using to access the KH1508Ai / KH1516Ai.
2. In order for the local and remote mice to synchronize, you must use the generic mouse driver supplied with the Windows operating system. If you have a third party driver installed - such as one supplied by the mouse manufacturer - you must remove it.
-

1. Windows 2000:

Set the mouse speed to the middle position; set the mouse acceleration to *None* (Control Panel → Mouse → Mouse Properties → Motion):

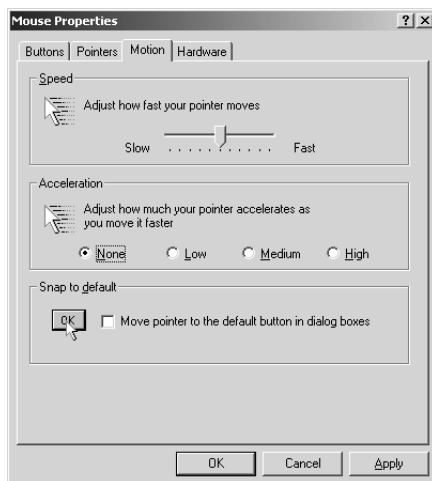

2. Windows XP / Windows Server 2003:

Set the mouse speed to the middle position; disable *Enhance Pointer Precision* (Control Panel → Printers and Other Hardware → Mouse → Pointer Options):

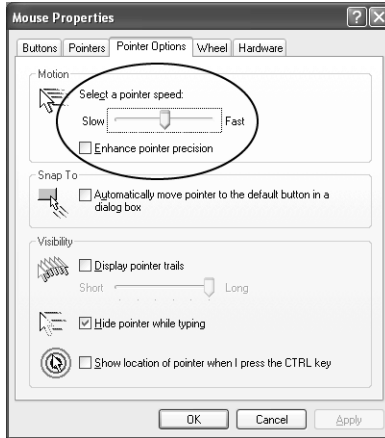

3. Windows ME / Windows 95:

Set the mouse speed to the middle position; disable mouse acceleration (click Advanced to get the dialog box for this).

4. Windows NT / Windows 98:

Set the mouse speed to the slowest position.

5. Sun / Linux:

Open a terminal session and issue the following command:

Sun: `xset m 1`

Linux: `xset m 0`

IP Address Determination

If you are an administrator logging in for the first time, you need to access the KH1508Ai / KH1516Ai in order to give it an IP address that users can connect to. There are three methods to choose from. In each case, your client computer must be on the same network segment as the KH1508Ai / KH1516Ai. After you have connected and logged in you can give the KH1508Ai / KH1516Ai its fixed network address. (See *Network*, page 115.)

The Local Console

The easiest way to assign an IP address is from the local console. Refer to *SET IP ADDRESS*, page 35, for details on the procedure involved.

IP Installer

For client computers running Windows, an IP address can be assigned with the *IP Installer* utility. The utility can be obtained from the *Download* area of our website. Look under *Driver/SW*, and the model of your switch. After downloading the utility to your client computer, do the following:

1. Unzip the contents of *IPInstaller.zip* to a directory on your hard drive.
2. Go to the directory that you unzipped the IPInstaller program to and run *IPInstaller.exe*. A dialog box similar to the one below appears:

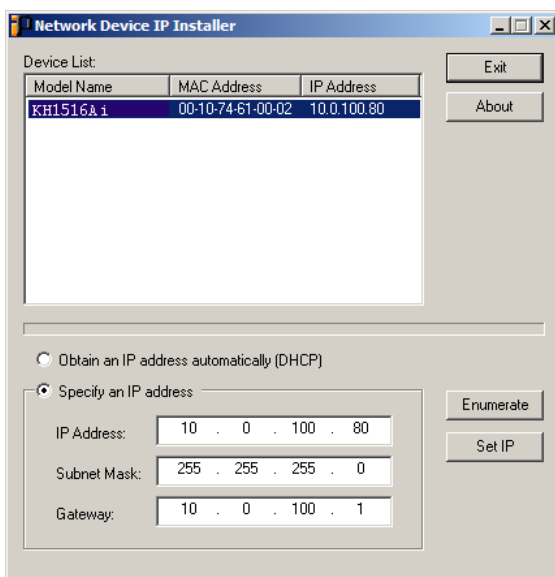

3. Select the KH1508Ai / KH1516Ai in the *Device List*.

Note: 1. If the list is empty, or your device doesn't appear, click **Enumerate** to refresh the Device List.

2. If there is more than one device in the list, use the MAC address to pick the one you want. The KVM Over the NET™ switch's MAC address is located on its bottom panel.
-

4. Select either *Obtain an IP address automatically (DHCP)*, or *Specify an IP address*. If you chose the latter, fill the IP Address, Subnet Mask, and Gateway fields with the information appropriate to your network.
5. Click **Set IP**.
6. After the IP address shows up in the Device List, click **Exit**. See *IP Installer*, page 116 for more information.

Browser

1. Set your client computer's IP address to 192.168.0.XXX
Where XXX represents any number or numbers except 60. (192.168.0.60 is the default address of the KH1508Ai / KH1516Ai.)
2. Specify the switch's default IP address (192.168.0.60) in your browser, and you will be able to connect.
3. Assign a fixed IP address for the KH1508Ai / KH1516Ai that is suitable for the network segment that it resides on.
4. After you log out, reset your client computer's IP address to its original value.

Specifications

Function		KH1508Ai	KH1516Ai	
Computer Connections	Direct	8	16	
	Max.	128 (via daisy chain)	256 (via daisy chain)	
Port Selection		OSD; Hotkey; Pushbutton		
Connectors	Console Port	Keyboard	1 x 6-pin Mini-DIN Female (Purple) 1 x USB Type A Female (White)	
		Video	1 x HDB-15 Female (Blue)	
		Mouse	1 x 6-pin Mini-DIN Female (Green) 1 x USB Type A Female (White)	
	KVM Port		8 x RJ-45 Female	16 x RJ-45 Female
	Daisy Chain Ports		1 x DB-25 Male (Black)	
	Power		1 x 3-prong AC socket	
	LAN		1 x RJ-45 Female	
	F/W Upgrade		1 x RJ-11 Female (Black)	
	PoN		1 x RJ-45 Female	
	Laptop Console		1 x USB Mini Type B Female (Black)	
Switches	Reset	1 x Semi-recessed Pushbutton		
	Power	1 x Rocker		
	Port Selection	8 x Pushbutton	16 x Pushbutton	
LEDs	On Line	8 (Green)	16 (Green)	
	Selected	8 (Orange)	16 (Orange)	
	Power	1 (Blue)		
	Station ID	1 x 2-digit 7-segment (Orange)		
	Link	1 (Orange)		
	10 / 100Mbps	1 (Orange / Green)		
Emulation	Keyboard/Mouse	PS/2, USB		
Video	Local	1600 x 1200 @ 60Hz (40m; 1280 x 1024 @ 75Hz (50m with KA7xxx Adapter Cable)		
	Remote	1600 x 1200 @ 60Hz		
Scan Interval		1–255 secs		
I/P Rating		100–240V AC; 50/60Hz; 1A		

Function		KH1508Ai	KH1516Ai
Power Consumption		AC110V:8.7W:49BTU/h AC220V:8.7W:49BTU/h	AC110V:8.9W:50BTU/h AC220V:8.9W:50BTU/h
		Note: <ul style="list-style-type: none"> ◆ The measurement in Watts indicates the typical power consumption of the device with no external loading. ◆ The measurement in BTU/h indicates the power consumption of the device when it is fully loaded. 	
Environment	Operating Temp.	0–50° C	
	Storage Temp.	-20–60° C	
	Humidity	0–80% RH; Non-condensing	
Physical Properties	Housing	Metal	
	Weight	2.68 kg (5.9 lb)	2.70 kg (5.95 lb)
	Dimensions L x W x H	43.72 x 16.36 x 4.40 cm (19"/1U) (17.21 x 6.44 x 1.73 in)	

Trusted Certificates

Overview

When you try to log in to the device from your browser, a Security Alert message appears to inform you that the device's certificate is not trusted, and asks if you want to proceed.



The certificate can be trusted, but the alert is triggered because the certificate's name is not found on Microsoft list of Trusted Authorities. You have two options: 1) you can ignore the warning and click **Yes** to go on; or 2) you can install the certificate and have it be recognized as trusted.

- ◆ If you are working on a computer at another location, accept the certificate for just this session by clicking **Yes**.
- ◆ If you are working at your own computer, install the certificate on your computer (see below for details). After the certificate is installed, it will be recognized as trusted.

Installing the Certificate

To install the certificate, do the following:

1. In the *Security Alert* dialog box, click **View Certificate**. The *Certificate Information* dialog box appears:

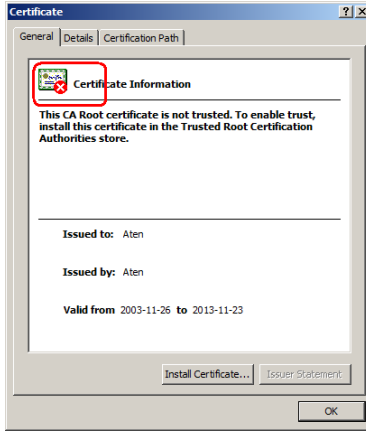

Note: There is a red and white X logo over the certificate to indicate that it is not trusted.

2. Click **Install Certificate**.
3. Follow the Installation Wizard to complete the installation. Unless you have a specific reason to choose otherwise, accept the default options.
4. When the Wizard presents a caution screen:

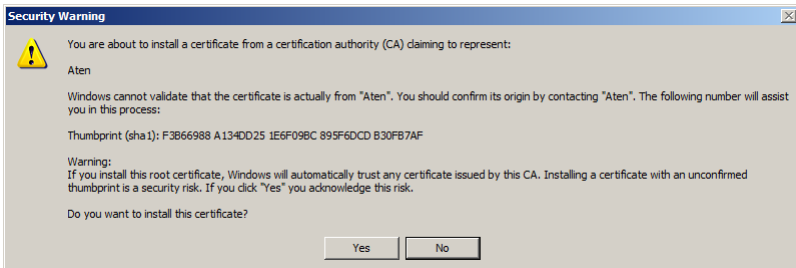

Click **Yes**.

- Next, click **Finish** to complete the installation; then click **OK** to close the dialog box.

Certificate Trusted

The certificate is now trusted:

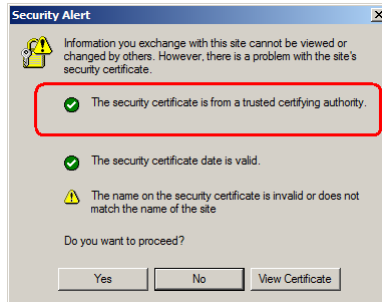

When you click *View Certificate*, you can see that the red and white X logo is no longer present – further indication that the certificate is trusted:

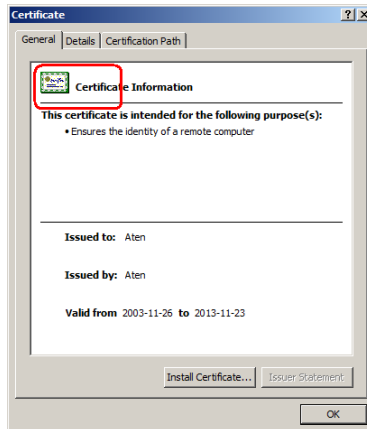

Self-Signed Private Certificates

If you wish to create your own self-signed encryption key and certificate, a free utility – `openssl.exe` – is available for download over the web at www.openssl.org. To create your private key and certificate do the following:

1. Go to the directory where you downloaded and extracted `openssl.exe` to.
2. Run `openssl.exe` with the following parameters:

```
openssl req -new -newkey rsa:1024 -days 3653 -nodes -x509  
-keyout CA.key -out CA.cer -config openssl.cnf
```

-
- Note:**
1. The command should be entered all on one line (i.e., do not press [Enter] until all the parameters have been keyed in).
 2. If there are spaces in the input, surround the entry in quotes (e.g., “ATEN International”).
-

To avoid having to input information during key generation the following additional parameters can be used:

```
/C /ST /L /O /OU /CN /emailAddress .
```

Examples

```
openssl req -new -newkey rsa:1024 -days 3653 -nodes -x509  
-keyout CA.key -out CA.cer -config openssl.cnf -subj  
/C=yourcountry/ST=yourstateorprovince/L=yourlocationor  
city/O=yourorganization/OU=yourorganizationalunit/  
CN=yourcommonname/emailAddress=name@yourcompany.com
```

```
openssl req -new -newkey rsa:1024 -days 3653 -nodes -x509  
-keyout CA.key -out CA.cer -config openssl.cnf -subj  
/C=CA/ST=BC/L=Richmond/O="ATEN International"/OU=ATEN  
/CN=ATEN/emailAddress=eservice@aten.com.tw
```

Importing the Files

After the `openssl.exe` program completes, two files – `CA.key` (the private key) and `CA.cer` (the self-signed SSL certificate) – are created in the directory that you ran the program from. These are the files that you upload in the *Private Certificate* panel of the Security page (see page 130).

Connection Tables

The following table indicates the relationship between the number of KH1508Ai / KH1516Ai units and the number of computers that they control

KH1508Ai

No.	Computers	No.	Computers
1	1 - 8	9	65 - 72
2	9 - 16	10	73 - 80
3	17 - 24	11	81 - 88
4	25 - 32	12	89 - 96
5	33 - 40	13	97 - 104
6	41 - 48	14	105 - 112
7	49- 56	15	113 - 120
8	57 - 64	16	121 - 128

KH1516Ai

No.	Computers	No.	Computers
1	1 - 16	9	129 - 144
2	17 - 32	10	145 - 160
3	33 - 48	11	161 - 176
4	49 - 64	12	177 - 192
5	65 - 80	13	193 - 208
6	81 - 96	14	209 - 224
7	97- 112	15	225 - 240
8	113 - 128	16	241 - 256

Supported Devices

The following table represents a list of supported devices that can be used on a KH1508Ai / KH1516Ai installation.

Type	
Daisy Chain Switches	KH1508A; KH1516A; ACS1208A; ACS1216A; CS1708A; CS1716A
PoN	PN0108
Central Control	CC2000

Note: To connect the KH1508Ai / KH1516Ai to a Power Over the NET™ unit, first use Cat 5e cable to connect the KH1508Ai / KH1516Ai's PoN port to an SN0142 adapter; then, connect the adapter to the PoN In port on the Power Over the NET™ unit.

OSD Factory Default Settings

The factory default settings are as follows:

Setting	Default
OSD Hotkey	[Scroll Lock] [Scroll Lock]
Port ID Display	Port Number + Name
Port ID Display Duration	5 Seconds
Scan / Skip Mode	All
Scan Duration	10 Seconds
Screen Blanker	0 Minutes (disabled)
Beeper	On
Accessible Ports	F (Full) For all Users on all Ports

Administrator Login Failure

If you are unable to perform an Administrator login (because the Username and Password information has become corrupted, or you have forgotten it, for example), there is a procedure you can use to clear the login information.

Note: Performing this procedure also returns all settings to their defaults.

To clear the login information (and return all settings to their defaults), do the following:

1. Power off the KH1508Ai / KH1516Ai and remove its housing.
2. Using a jumper cap, short the jumper on the mainboard, labeled **J15**.

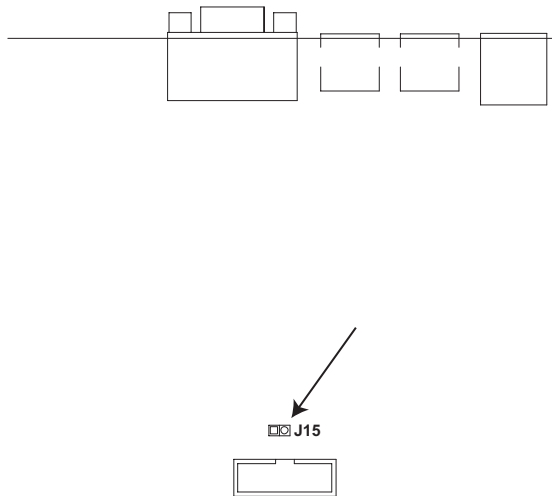

3. Power on the switch.
4. Wait a few seconds. When the front panel LEDs flash, power off the switch.
5. Remove the jumper cap from **J15**.
6. Close the housing and power on the KH1508Ai / KH1516Ai.

After powering on the unit, you can use the default Username and Password (see *OSD Overview*, page 27), to log in.

ATEN Standard Warranty Policy

Limited Hardware Warranty

ATEN warrants its hardware in the country of purchase against flaws in materials and workmanship for a Warranty Period of two [2] years (warranty period may vary in certain regions/countries) commencing on the date of original purchase. This warranty period includes the [LCD panel of ATEN LCD KVM switches](#). For UPS products, the device warranty is two [2] years but battery is one [1] year. Select products are warranted for an additional year (see [A+ Warranty](#) for further details). Cables and accessories are not covered by the Standard Warranty.

What is covered by the Limited Hardware Warranty

ATEN will provide a repair service, without charge, during the Warranty Period. If a product is defective, ATEN will, at its discretion, have the option to (1) repair said product with new or repaired components, or (2) replace the entire product with an identical product or with a similar product which fulfills the same function as the defective product. Replaced products assume the warranty of the original product for the remaining period or a period of 90 days, whichever is longer. When the products or components are replaced, the replacing articles shall become customer property and the replaced articles shall become the property of ATEN.

To learn more about our warranty policies, please visit our website:

<http://www.aten.com/global/en/legal/policies/warranty-policy/>

© Copyright 2024 ATEN® International Co., Ltd.
Released: 2024-09-03

ATEN and the ATEN logo are registered trademarks of ATEN International Co., Ltd. All rights reserved. All other brand names and trademarks are the registered property of their respective owners.