



**KVM Switch
KH1508 / KH1516
User Manual**



FCC Information

This is an FCC Class A product. In a domestic environment this product may cause radio interference in which case the user may be required to take adequate measures.

This equipment has been tested and found to comply with the limits for a Class A digital device, pursuant to Part 15 of the FCC Rules. These limits are designed to provide reasonable protection against harmful interference when the equipment is operated in a commercial environment. This equipment generates, uses and can radiate radio frequency energy and, if not installed and used in accordance with the instruction manual, may cause harmful interference to radio communications. Operation of this equipment in a residential area is likely to cause harmful interference in which case the user will be required to correct the interference at his own expense.

RoHS

This product is RoHS compliant.

SJ/T 11364-2006

The following contains information that relates to China.

部件名称	有毒有害物质或元素					
	铅	汞	镉	六价铬	多溴联苯	多溴二苯醚
电器部件	●	○	○	○	○	○
机构部件	○	○	○	○	○	○

- : 表示该有毒有害物质在该部件所有均质材料中的含量均在SJ/T 11363-2006规定的限量要求之下。
- : 表示符合欧盟的豁免条款, 但该有毒有害物质至少在该部件的某一均质材料中的含量超出SJ/T 11363-2006的限量要求。
- ×: 表示该有毒有害物质至少在该部件的某一均质材料中的含量超出SJ/T 11363-2006的限量要求。



User Information

Online Registration

Be sure to register your product at our online support center:

International		http://support.aten.com
North America	ATEN TECH	http://www.aten-usa.com/product_registration
	ATEN NJ	http://support.aten.com

Telephone Support

For telephone support, call this number:

International		886-2-8692-6959
North America	ATEN TECH	1-888-999-ATEN
	ATEN NJ	1-732-356-1703

User Notice

All information, documentation, and specifications contained in this manual are subject to change without prior notification by the manufacturer. The manufacturer makes no representations or warranties, either expressed or implied, with respect to the contents hereof and specifically disclaims any warranties as to merchantability or fitness for any particular purpose. Any of the manufacturer's software described in this manual is sold or licensed *as is*. Should the programs prove defective following their purchase, the buyer (and not the manufacturer, its distributor, or its dealer), assumes the entire cost of all necessary servicing, repair and any incidental or consequential damages resulting from any defect in the software.

The manufacturer of this system is not responsible for any radio and/or TV interference caused by unauthorized modifications to this device. It is the responsibility of the user to correct such interference.

The manufacturer is not responsible for any damage incurred in the operation of this system if the correct operational voltage setting was not selected prior to operation. PLEASE VERIFY THAT THE VOLTAGE SETTING IS CORRECT BEFORE USE.

Package Contents

The KH1508 / KH1516 package consists of:

- 1 KH1508 or KH1516 Cat 5 High-Density KVM Switch
- 1 Firmware Upgrade Cable
- 1 Power Cord
- 1 Rack Mount Kit
- 1 Foot Pad Set (4 pcs.)
- 1 User Manual*
- 1 Quick Start Guide

Check to make sure that all of the components are present and in good order. If anything is missing, or was damaged in shipping, contact your dealer.

Read this manual thoroughly and follow the installation and operation procedures carefully to prevent any damage to the switch or to any other devices on the KH1508 / KH1516 installation.

* Features may have been added to the KH1508 / KH1516 since this manual was printed. Please visit our web site to download the most up-to-date version of the manual.

Copyright © 2008 ATEN® International Co., Ltd.
Manual Part No. PAPE-0268-3AXG
Manual Date: 2010-09-14

Altusen and the Altusen logo are registered trademarks of ATEN International Co., Ltd. All rights reserved.
All other brand names and trademarks are the registered property of their respective owners.

Contents

FCC Information	ii
RoHS	ii
SJ/T 11364-2006	ii
User Information	iii
Online Registration	iii
Telephone Support	iii
User Notice	iii
Package Contents	iv
About This Manual	viii
Overview	viii
Conventions	ix
Product Information	ix

Chapter 1.

Introduction

Overview	1
Features	3
Requirements	4
Console	4
Computers	4
KVM Adapter Cables	4
Operating Systems	5
Components	6
Front View	6
KH1508	6
KH1516	6
Rear View	8
KH1508	8
KH1516	8

Chapter 2.

Hardware Setup

Overview	9
Before you Begin	9
Stacking and Rack Mounting	10
Stacking	10
Rack Mounting	11
Single Station Installation	12
Daisy Chaining	15

Chapter 3.

Basic Operation

Port Selection	17
Manual	17

OSD	17
Hotkey	17
Hot Plugging	18
Hot Plugging Stations	18
Hot Plugging KVM Ports	18
Hot Plugging Console Ports	18
Powering Off and Restarting	19
Port ID Numbering	19

Chapter 4.

OSD Operation

OSD Overview	21
OSD Navigation	23
OSD Main Screen Headings	23
OSD Functions	24
F1: GOTO	24
F2: LIST	25
F3: SET	26
F4: ADM	28
F5: SKP	32
F6: BRC	33
F7: SCAN	34
F8: LOUT	35

Chapter 5.

Keyboard Port Operation

Overview	37
Invoking Hotkey Mode	37
Selecting the Active Port	38
Auto Scanning	38
Setting the Scan Interval	38
Invoking Auto Scan	39
Skip Mode	40
Hotkey Beeper Control	40
Hotkey Summary Table	41

Chapter 6.

Keyboard Emulation

Mac Keyboard	43
Sun Keyboard	44

Chapter 7.

The Firmware Upgrade Utility

Introduction	45
Before You Begin	45
Performing the Upgrade	46

Starting the Upgrade	46
Upgrade Succeeded	49
Upgrade Failed	49
Firmware Upgrade Recovery	50
Adapter Cable Upgrade	51
Introduction	51
Before You Begin	51
Performing the Upgrade	52
Starting the Upgrade	52
Upgrade Succeeded	53
Adapter Cable Firmware Upgrade Recovery	54

Appendix

Safety Instructions.	55
General	55
Rack Mounting	57
Technical Support	58
International.	58
North America	58
Specifications	59
Connection Tables	60
KH1508	60
KH1516	60
OSD Factory Default Settings.	61
Administrator Login Failure	62
Troubleshooting	63
Overview	63
User Manual Corrections	64
Limited Warranty.	65

About This Manual

This User Manual is provided to help you get the most from your KH1508 / KH1516 system. It covers all aspects of installation, configuration and operation. An overview of the information found in the manual is provided below.

Overview

Chapter 1, Introduction, introduces you to the KH1508 / KH1516 system. Its purpose, features and benefits are presented, and its front and back panel components are described.

Chapter 2, Hardware Setup, describes how to set up your installation. The necessary steps – from a basic single stage hookup to a complete 32 switch daisy chained operation are provided.

Chapter 3, Basic Operation, explains the fundamental concepts involved in operating the KH1508 / KH1516.

Chapter 4, OSD Operation, provides a complete description of the KH1508 / KH1516's OSD (On Screen Display), and how to work with it.

Chapter 5, Keyboard Port Operation, details all of the concepts and procedures involved in the keyboard hotkey operation of your KH1508 / KH1516 installation.

Chapter 6, Keyboard Emulation, provides tables that list the PC to Mac and PC to Sun keyboard emulation mappings.

Chapter 7, The Firmware Upgrade Utility, explains how to upgrade the KH1508 / KH1516's firmware with the latest available versions.

An Appendix, provides specifications and other technical information regarding the KH1508 / KH1516.

Conventions

This manual uses the following conventions:

- Monospaced Indicates text that you should key in.
- [] Indicates keys you should press. For example, **[Enter]** means to press the **Enter** key. If keys need to be chorded, they appear together in the same bracket with a plus sign between them: [Ctrl+Alt].
1. Numbered lists represent procedures with sequential steps.
- ◆ Bullet lists provide information, but do not involve sequential steps.
- Indicates selecting the option (on a menu or dialog box, for example), that comes next. For example, *Start* → *Run* means to open the *Start* menu, and then select *Run*.
-  Indicates critical information.

Product Information

For information about all ALTUSEN products and how they can help you connect without limits, visit ALTUSEN on the Web or contact an ALTUSEN Authorized Reseller. Visit ALTUSEN on the Web for a list of locations and telephone numbers:

International		http://www.aten.com
North America	ATEN TECH	http://www.aten-usa.com
	ATEN NJ	http://www.aten.com

This Page Intentionally Left Blank

Chapter 1

Introduction

Overview

KH1508 / KH1516 KVM switches are control units that allow access to multiple computers from a single KVM (keyboard, monitor, and mouse) console.

A single KH1508 / KH1516 can control up to 8 / 16 computers. As many as 31 additional KH1508 / KH1516 switches can be daisy chained from the original unit, so that up to 512 computers can all be controlled from the original KVM console.

Note: ATEN ACS1208 / ACS1216 switches can also be installed on a KH1508 / KH1516 daisy chain.

A custom ASIC (patent pending) provides an auto-sensing function that recognizes the position of each station on the chain, eliminating the need to manually set the position with DIP switches. A seven-segment front panel LED displays each Station's position for easy identification.

The switches feature RJ-45 connectors and use CAT 5e cable to link to the computers. Combined with Auto Signal Compensation (ASC), 1280 x 1024 @ 60 Hz signals can travel up to 40 m (130 feet) – eliminating the need for KVM extenders. Utilizing PS/2 and USB KVM adapter cables for the final linkup, the KH1508 / KH1516 permits any combination of PCs, Macs, Sun computers, and serial devices to coexist on the installation.

Your KH1508 / KH1516 investment is protected by a Firmware Upgrade Utility. You can stay current with the latest improvements in functionality by downloading firmware update files from our website, and using the utility to quickly and conveniently install them.

Setting up the KH1508 / KH1516 is fast and easy; plugging cables into their appropriate ports is all that is entailed. Because the KH1508 / KH1516 intercepts keyboard and mouse input directly, there is no software to configure; no need to get involved in complex installation routines; no need to be concerned with incompatibility problems.

Access to any computer on the installation is easily accomplished – either by pressing front panel port selection switches; entering hotkey combinations from the keyboard; or by means of a powerful menu driven OSD system.

A convenient Auto Scan function also permits automatic scanning and one-by-one monitoring of the activities of selected computers.

There is no better way to save time and money than with a KH1508 / KH1516 installation. By allowing a single console to manage up to 512 computers, a KH1508 / KH1516 installation: (1) eliminates the expense of having to purchase a separate keyboard, monitor, and mouse for each; (2) saves all the space those extra components would take up; (3) saves on energy costs; and (4) eliminates the inconvenience and wasted effort involved in constantly moving from one computer to another.

Features

- ◆ A single console controls up to 8 (KH1508) or 16 (KH1516) computers
- ◆ Dedicated chain ports – daisy chain up to 31 additional units – control up to 512 computers from a single console
- ◆ Extends the distance between computers and switch – up to 30 m (100 feet) for resolutions of 1600 x 1200 @ 60 Hz; up to 40 m (130 feet) for resolutions of 1280 x 1024 @ 60 Hz
- ◆ Custom ASIC (patent pending) auto-senses station's position on daisy chained installations – no need for manual DIP switch setting – front panel LED indicates station's position
- ◆ Multiplatform support: PC, Mac, Sun and terminal-based systems
- ◆ No software required – convenient computer selection via port selection switches, *Hotkeys* and intuitive on-screen display (OSD) menus
- ◆ Auto Scan feature for monitoring user-selected computers
- ◆ Hot Pluggable – add or remove switches/computers without having to power down the switches
- ◆ Two level password security – only authorized users view and control the computers – up to four Users plus an Administrator with separate profiles for each
- ◆ Two level logout – Manual and Timed
- ◆ PS/2 keyboard and mouse emulation – computers boot even when the console focus is elsewhere
- ◆ Superior video quality – supports resolutions up to 1600 x 1200 @ 60 Hz; DDC2B
- ◆ Multi-language keyboard support: English (US / UK); French; German; Japanese; Korean; Traditional Chinese
- ◆ Rack mountable in 19" System Rack (1U)

Requirements

Console

- ◆ A VGA, SVGA, or multisync monitor capable of the highest resolution that you will be using on any computer in the installation
- ◆ A PS/2 style mouse
- ◆ A PS/2 style keyboard

Computers

The following equipment must be installed on the computers that connect to the KH1508 or KH1516 KVM ports:

- ◆ A VGA, SVGA or multisync port
- ◆ A Type A USB port and USB host controller (for USB KVM adapter cable connection, see below)
- ◆ 6-pin Mini-DIN keyboard and mouse ports (for PS/2 KVM adapter cable connection, see below)

KVM Adapter Cables

- ◆ Cat 5e cable is required to connect the KH1508 / KH1516 to one of the KVM adapter cables.
- ◆ The following KVM adapter cables are required for use with the KH1508 / KH1516:

Function	Module
Connect to devices with PS/2 ports	KA9520
Connect to devices with USB ports	KA9570
Connect to Sun Legacy systems (with 13W3 port)	KA9130
Connect to Sun USB systems	KA9131
Connect to serial based devices	KA9140

Note: KVM adapter cables are referred to as *I/O Modules* in some dialog boxes.

Operating Systems

Supported operating systems are shown in the table, below:

OS		Version
Windows		95 and higher
Linux	RedHat	6.0 and higher
	SuSE	8.2 and higher
	Mandriva (Mandrake)	9.0 and higher
UNIX	AIX	4.3 and higher
	FreeBSD	3.51 and higher
	Sun	Solaris 8 and higher
Novell	Netware	5.0 and higher
OS/2		Warp and higher
DOS		6.2 and higher

Components

Front View

KH1508

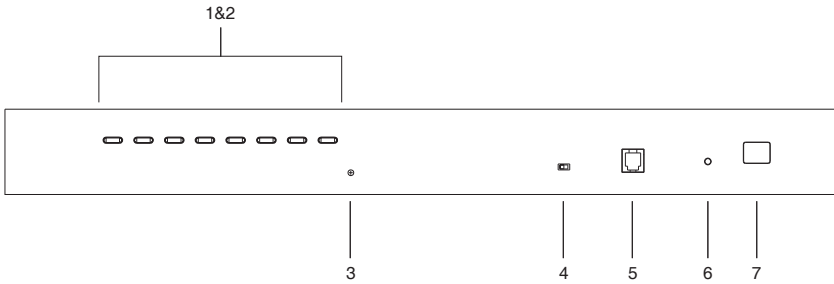

KH1516

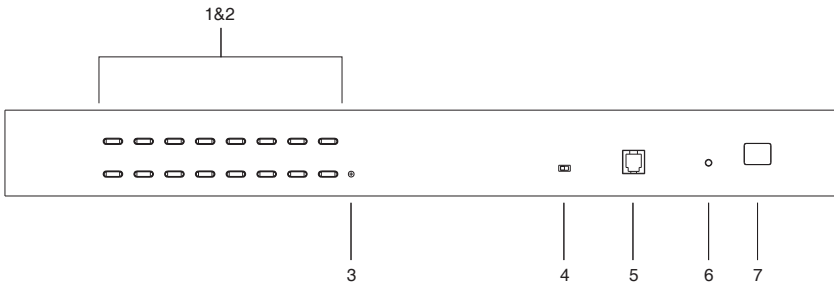

No.	Component	Description
1	Port Selection Switches	<ul style="list-style-type: none"> ◆ Press a switch to give the KVM focus to the computer attached to its corresponding port. ◆ Simultaneously pressing Buttons 1 and 2 for 3 seconds performs a keyboard and mouse reset. ◆ Simultaneously pressing Buttons 7 and 8 starts Auto Scan mode.
2	Port LEDs	<p>The Port LEDs are built into the Port Selection Switches. The left ones are the <i>On Line</i> LEDs; the right ones are the <i>Selected Port</i> LEDs:</p> <ul style="list-style-type: none"> ◆ An On Line LED lights GREEN to indicate that the computer attached to its corresponding port is up and running. A flashing LED indicates that the Port is being used for cascading to another switch. ◆ A Selected LED lights ORANGE to indicate that the computer attached to its corresponding port is the one that has the KVM focus. The LED is steady under normal conditions, but flashes when its port is accessed under Auto Scan mode.
3	Reset Switch	<p>Pressing this switch in performs a system reset.</p> <p>Note: The switch is recessed and must be pushed with a small object, such as the end of a paper clip, or a ballpoint pen.</p>
4	Firmware Upgrade Recovery Switch	<p>During normal operation and while performing a firmware upgrade, this switch should be in the NORMAL position. If a firmware upgrade operation does not complete successfully, this switch is used to perform a firmware upgrade recovery. See <i>Firmware Upgrade Recovery</i>, page 50 for details.</p>
5	Firmware Upgrade Port	<p>The Firmware Upgrade Cable that transfers the firmware upgrade data from the administrator's computer to the KH1508 / KH1516 (see page 45), plugs into this RJ-11 connector.</p>
6	Power LED	<p>Lights to indicate that the KH1508 / KH1516 is powered and ready to operate.</p>
7	Station ID LED	<p>The KH1508 / KH1516's Station ID is displayed here. If this is a single station installation (see page 12), or the first station on a daisy chained installation (see page 15), the KH1508 / KH1516 has a station ID of 01.</p> <p>On a daisy chained installation, the KH1508 / KH1516 auto-senses its position and displays the station ID that corresponds to its place in the chain. (see <i>Port ID Numbering</i>, page 19, for details).</p>

Rear View

KH1508

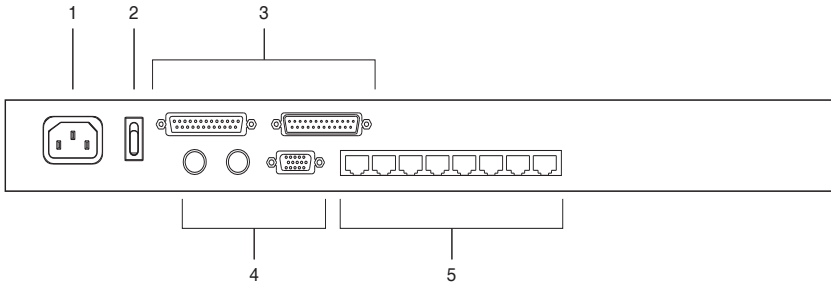

KH1516

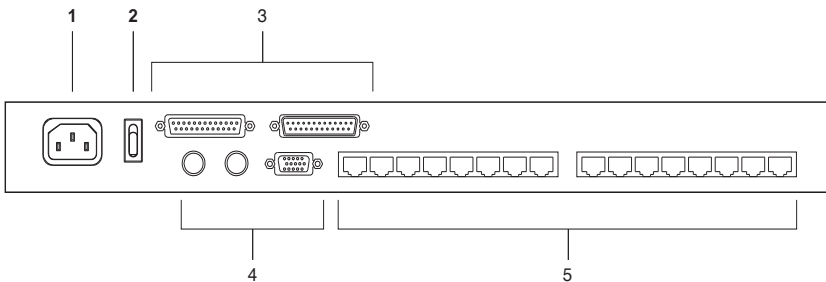

No.	Component	Description
1	Power Socket	The power cord to the AC source plugs in here.
2	Power Switch	This is a standard rocker switch that powers the KH1508 / KH1516 on and off.
3	Daisy Chain Ports	When daisy chaining units (see <i>Daisy-chaining</i> , page 15), the daisy chain cables plug in here. The port on the left is the <i>Chain In</i> port; the port on the right is the <i>Chain Out</i> port.
4	Local Console Port Section	If this is a single station installation, or if this is the first station of a daisy chained installation, the keyboard, monitor, and mouse that make up the local console plug in here.
5	KVM Port Section	The Cat 5 cables that link to the KVM adapter cables (which link to the computers) plug in here.

Chapter 2

Hardware Setup

Overview

For convenience and flexibility that allows mixing the PS/2, USB and serial interfaces, the KH1508 / KH1516's design utilizes KVM adapter cables that serve as intermediaries between the KVM switch and the connected devices:

A separate KVM adapter cable is required for each computer or device connection. The KVM adapter cables are listed in the *KVM Adapter Cables* section on page 4. Consult your dealer to find out which KVM adapter cables best fit your needs.

Before you Begin



1. Important safety information regarding the placement of this device is provided on page 55. Please review it before proceeding.
2. Make sure that the power to any device that you connect to the installation has been turned off. You must unplug the power cords of any computers that have the Keyboard Power On function.

Stacking and Rack Mounting

The KH1508 / KH1516 can be stacked on the desktop or rack mounted at the front or rear of the rack. The following sections take you through the procedures for each method.

-
- Note:** 1. Allow at least 5.1 cm on each side for adequate ventilation and 12.7 cm at the rear for power cord and cable clearance.
2. The standard rack mount kit does not include rack mount screws or cage nuts. If you need additional rack mount screws or cage nuts, contact your rack dealer.
-

Stacking

The KH1508 / KH1516 can be placed on any appropriate level surface that can safely support its weight plus the weight of its attached cables. To place the KH1508 / KH1516, or to stack units if you are daisy chaining them, remove the backing material from the bottom of the rubber feet that came with this package, and stick them onto the switch's bottom panel at the corners, as shown in the diagram, below:

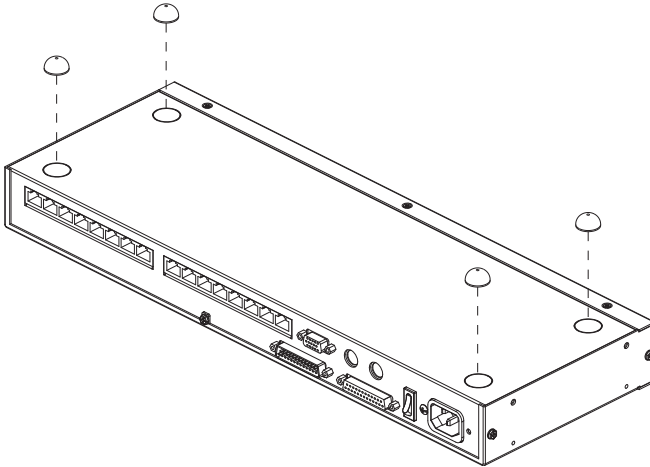

Rack Mounting

The KH1508 / KH1516 can be mounted in a 19" (1U) rack. The mounting brackets can screw into either the front or the back of the unit so that it can attach to the front or the back of the rack. To rack mount the unit:

1. Remove the screws at the front or the rear, as shown in the diagram below.

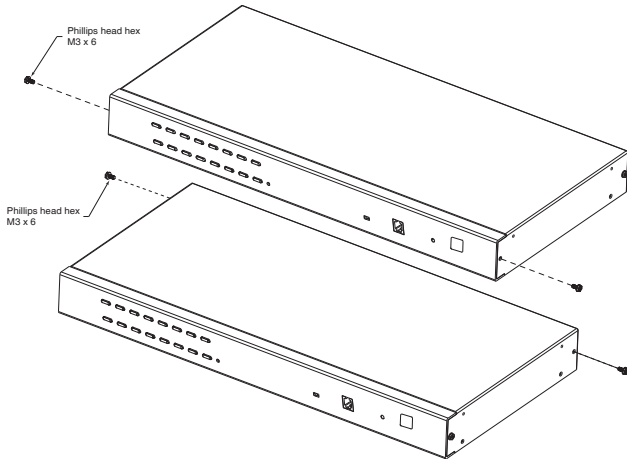

2. Screw the mounting brackets into the sides of the unit at the front or the rear, as shown in the diagram below.

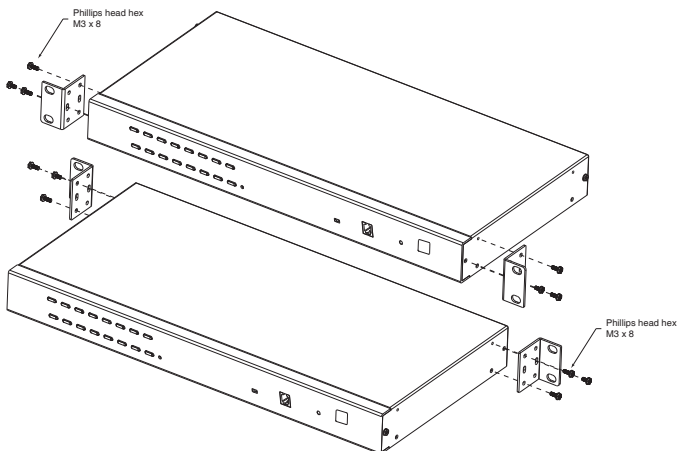

3. Slide the unit into the front or rear of the rack and secure it to the rack.

Single Station Installation

In a single stage installation, there are no additional KVM switches daisy chained down from the KH1508 / KH1516. To set up a single stage installation, refer to the installation diagrams starting on page 13 (the numbers in the diagram correspond with the numbers of the instruction steps), and do the following:

1. Plug your local console's keyboard, monitor, and mouse into the unit's console ports. Each port is color coded and marked with an appropriate icon.
2. Use Cat 5e cable to connect any available KVM port to a KVM adapter cable that is appropriate for the computer you are installing (see *KVM Adapter Cables*, page 4 for details).

Note: The KH1508 / KH1516 does not support distances between itself and the KVM adapter cable that exceed 40 m.

3. Connect the KVM adapter cable to the computer.
Plug the connectors on the KVM adapter cable into the appropriate ports of the computer you are installing. (See *KVM Adapter Cable Installation Diagrams*, page 14 for connection examples.)
4. Plug the female end of the power cord into the KH1508 / KH1516's power socket; plug the male end into an AC power source.
5. Turn on the power to the KH1508 / KH1516.

After the KH1508 / KH1516 is powered up, you can turn on the computers.

Single Stage Installation Diagram

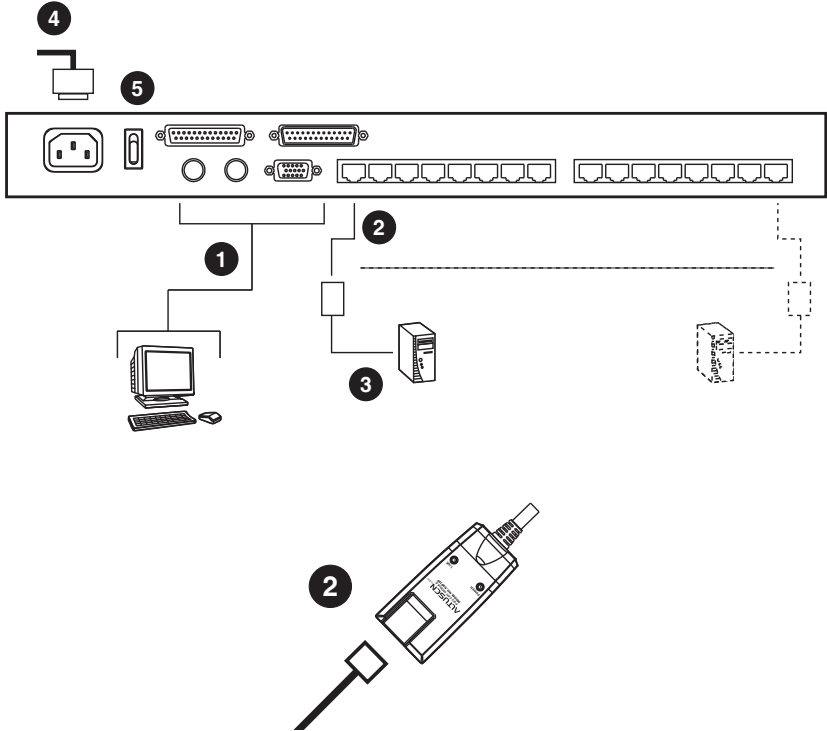

KVM Adapter Cable Installation Diagrams

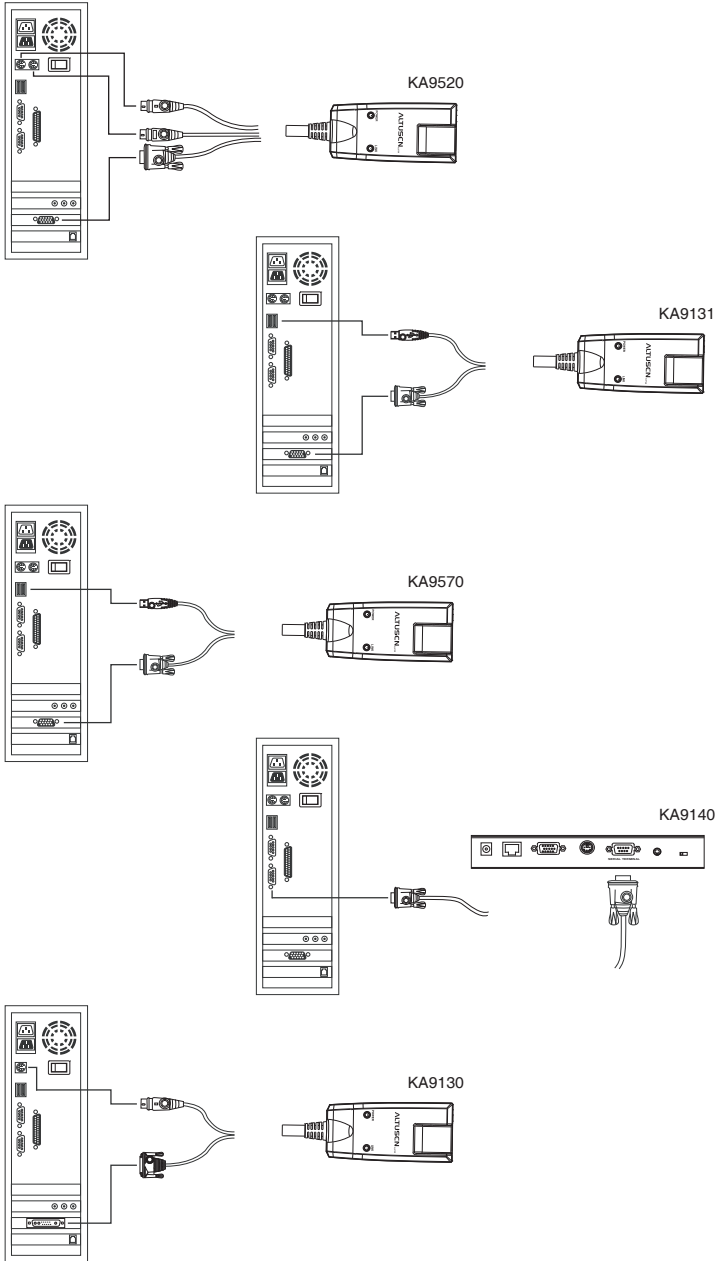

Daisy Chaining

To control even more computers, up to 31 additional KH1508 / KH1516 KVM switches can be daisy chained from the KH1508 or KH1516. As many as 512 computers can be controlled from a single console in a complete installation.

Note: ATEN ACS1208 / ACS1216 switches can also be installed on a KH1508 / KH1516 daisy chain.

Tables showing the relation between the number of computers and the number of KH1508 / KH1516 units needed to control them are provided on page 59.

To set up a daisy chained installation, do the following:

1. Use a daisy chain cable set to connect the *Chain Out* port of the parent KH1508 / KH1516 unit to the *Chain In* port of the child KH1508 / KH1516 unit (first station out to second station in, second station out to third station in, etc.).

Note: 1. you cannot use the chain in port of the First Station, since it is the highest level parent.

2. Daisy chain cable sets require a separate purchase. See your dealer for details.
-

2. Use Cat 5e cable to connect any available KVM port to a KVM Adapter cable that is appropriate for the computer you are installing (see *KVM Adapter Cables*, page 4 for details).

Note: The KH1508 / KH1516 does not support distances between itself and the KVM adapter cable that exceed 40 m.

3. Connect the KVM adapter cable to the computer.
 4. Use the power cord supplied with this package to connect the KH1508 / KH1516 to an AC power source.
 5. Repeat steps 1–4 for any other switches you want to add to the chain.
 6. Power up the installation according to the following procedure:
 - a) Plug in the power cord for the first station. Wait for the unit to ascertain its station ID and display it on the Station ID LED. (The station ID for the first stage unit is 01, the ID for the second stage unit is 02, the ID for the third stage unit is 03, etc.)
-

- b) Power on each station on the installation in turn (second station, then third station, etc.). In each case, wait for the station ID to be ascertained and displayed before powering on the next station.
- c) After all the stations are up, power on the computers.

Daisy Chain Installation Diagram

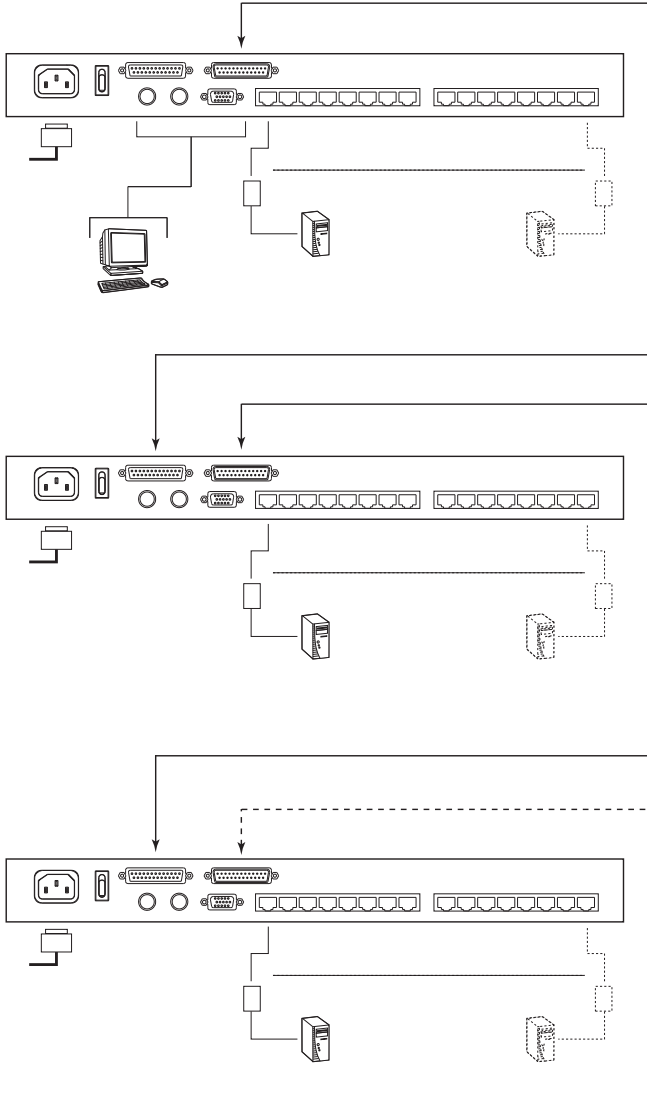

Chapter 3

Basic Operation

Port Selection

KH1508 / KH1516 installations provide three methods to obtain instant access to any computer in your installation: Manual, OSD (on-screen display), and Hotkey.

Manual

For a stand alone switch, or the first stage unit of a daisy chained installation, simply press the port switch that corresponds to the device you wish to access.

For a daisy chained switch, do the following:

1. Press the port switch on the parent unit that the daisy chained switch is connected to.
2. Press the port switch on the daisy chained switch that corresponds to the device you wish to access.

Note: On a multi-stage installation (see *Daisy-chaining*, page 15), work your way back to the first stage unit.

OSD

The OSD provides a menu driven interface to the computer switching procedure. OSD operation is discussed in the next chapter.

Hotkey

Hotkeys allow you to conveniently provide KVM focus to a particular computer from the keyboard instead of having to manually select them by pressing port selection switches, or accessing the OSD. Keyboard operation is discussed in Chapter 5.

Hot Plugging

The KH1508 / KH1516 supports hot plugging – components can be removed and added back into the installation by unplugging and replugging their cables from their ports without the need to shut the unit down. In order for hot plugging to work properly, however, the procedures described below must be followed.

Hot Plugging Stations

You can switch station positions by simply unplugging from the old parent and plugging into a new one. After you do, in order for the OSD menus to correspond to the change, you must reset the OSD. See *RESET STATION IDS*, page 30, for details.

Hot Plugging KVM Ports

After switching KVM ports, in order for the OSD menus to correspond to the change, you must manually reconfigure the OSD information for the new port information. See *F3: SET*, page 26, and the port setting selections under the *F4 ADM* function, page 28, for details.

Note: If a computer's operating system doesn't support hot plugging, this function may not work properly.

Hot Plugging Console Ports

Keyboard, monitor, and mouse can all be hot plugged. When hot plugging the mouse:

- ◆ You may unplug the mouse and plug it back in again (to reset the mouse, for example), as long as you use the *same* mouse.
- ◆ If you plug in a different mouse, all the stations and all the computers on the installation must be shut down for 10 seconds, then restarted following the Power Up Sequence described under Step 6 on page 15.)

Note: If, after hot plugging (or at any other time), there is no response to keyboard and/or mouse input, perform a keyboard and mouse reset by pressing in the Reset switch (see page 7).

Powering Off and Restarting

If it becomes necessary to power off the KH1508 / KH1516, or if the switch loses power and needs to be restarted, before starting it back up you must follow these procedures:

1. Shut down all the computers that are attached to it.

Note: You must unplug the power cords of any computers that have the Keyboard Power On function.

2. Wait 10 seconds then power it back on. If you have shut down more than one station, power up the highest station first and work your way down to the lowest one. Wait for each station to display its station ID on the front panel LED before powering on the next one.
3. After the station(s) is (are) up, power the computers back on.

Port ID Numbering

Each computer on the installation is assigned a unique port ID. The port ID is a one or two segment number that is determined by the stage level and KVM port number of the KVM switch that the computer is connected to.

The first segment represents the stage level of the KVM switch; the second segment represents the KVM port number that the computer is plugged into.

For example, a computer that is connected to KVM port 3 of a switch that is in the 12th position of the daisy chain, would have a port ID of 12-03.

Note: Single digit numbers (1–9) are padded with a preceding zero (0).

This Page Intentionally Left Blank

Chapter 4

OSD Operation

OSD Overview

The on-screen display (OSD) is a menu driven method to handle computer control and switching operations. All procedures start from the OSD Main Screen. To display the Main Screen, tap [**Scroll Lock**] twice.

Note: You can optionally change the OSD hotkey to the Ctrl key, in which case you would tap [Ctrl] twice (see *OSD HOTKEY*, page 26). With this method, you must press the same [Ctrl] key.

The OSD incorporates a two level (administrator / user) password system. Before the OSD Main Screen displays, a login dialog box appears that asks for a username and password. If the password function has been set, you must provide a valid username and password in order to access the OSD Main Screen.

The first time that the OSD is accessed, or if the password function has not been set, no password is required, simply press [**Enter**]. The OSD Main Screen opens in Administrator mode. In this mode, you have administrator privileges, with access to all administrator and user functions, and can set up operations (including password authorization for the future), as you would like.

When you invoke the OSD, a screen similar to the one below appears:



-
- Note:**
1. The diagram depicts the Administrator's Main Screen. The User Main Screen does not show the **F4** and **F6** functions, since these are reserved for the administrator and can't be accessed by ordinary users.
 2. The OSD always starts in List view with the highlight bar at the same position it was in the last time it was closed.
 3. Only the ports that have been set accessible by the Administrator for the currently logged in user are visible (see *SET ACCESSIBLE PORTS*, page 30, for details).
-

OSD Navigation

- ◆ To dismiss the menu, and deactivate the OSD, click the **X** at the upper right corner of the OSD Window or press **Esc**.
- ◆ To Logout click **F8** or the **ZZ^Z** symbol at the top of the Main Screen, or press **[F8]**.
- ◆ The OSD uses a tree view. To see the ports for a particular station, click the plus sign [+] in front of the station number. The port number list drops down. To dismiss the list, click the circle symbol [o] in front of the station number.
- ◆ To move up or down through the list one line at a time, click the up and down triangle symbols (▲▼) or use the up and down arrow keys. If there are more list entries than there is room for on the Main Screen, the screen will scroll.
- ◆ To move up or down through the list one screen at a time, click the up and down arrow symbols (↑↓), or use the [Pg Up] and [Pg Dn] keys. If there are more list entries than there is room for on the Main Screen, the screen will scroll.
- ◆ To bring the KVM focus to a port, double-click it, or move the highlight bar to it and then press **[Enter]**.
- ◆ After executing any action, you automatically go back to the menu one level above.

OSD Main Screen Headings

Heading	Explanation
SN-PN	This column lists the port ID numbers (station number-port number) for all the KVM ports on the installation. The simplest method to access a particular computer is to click it, or move the highlight bar to it, and then press [Enter] .
QV	If a port has been selected for Quick View scanning (see <i>SET QUICK VIEW PORTS</i> , page 30), an arrowhead displays in this column.
	The computers that are powered on and are online have a sun symbol in this column.
NAME	If a port has been given a name (see <i>EDIT PORT NAMES</i> , page 29), its name appears in this column.

OSD Functions

OSD functions are used to configure and control the OSD. For example, you can rapidly switch to any port, scan selected ports only, limit the list you wish to view, designate a port as a Quick View Port, create or edit a port name, or make OSD setting adjustments.

To access an OSD function:

1. Either click a function key field at the top of the Main Screen, or press a function key on the keyboard.
2. In the submenus that appear make your choice either by double clicking it, or moving the highlight bar to it, and then pressing [**Enter**].
3. Press [**Esc**] to return to the previous menu level.

F1: GOTO

GOTO allows you to switch directly to a port either by keying in the port's name or its port ID.

- ♦ To use the Name method, key in **1**, key in the port's name, and then press [**Enter**].
- ♦ To use the Port ID method, key in **2**, key in the port ID, and then press [**Enter**].

Note: You can key in a partial name or port ID. The screen will show all the computers that the user has *View* rights to (see *SET ACCESSIBLE PORTS*, page 30), that match the name or port ID pattern, regardless of the current *List* settings (see *F2: LIST*, page 25, for details).

To return to the OSD Main Menu without making a choice, press [**Esc**].

F2: LIST

This function lets you broaden or narrow the scope of ports the OSD displays on the Main Screen. Many of the OSD functions only operate on the computers currently selected for listing on the Main Screen with this function. The submenu choices and their meanings are given in the table below:

Choice	Meaning
ALL	Lists all of the ports on the installation.
QUICK VIEW	Lists only the ports that have been selected as Quick View Ports (see <i>SET QUICK VIEW PORTS</i> , page 30).
POWERED ON	Lists only the ports that have attached computers Powered On.
QUICK VIEW + POWERED ON	Lists only the ports that have been selected as Quick View Ports (see <i>SET QUICK VIEW PORTS</i> , page 30), and that have their attached computers Powered On.

Move the highlight bar to the choice you want, then press **[Enter]**. An icon appears before the choice to indicate that it is the currently selected one.

F3: SET

This function allows the administrator and each user to set up an individual working environment. A separate profile for each is stored by the OSD and is activated according to the username provided during Login.

To change a setting:

1. Double-click it; or move the highlight bar to it, then press **[Enter]**.
2. After you select an item, a submenu with further choices appears. To make a selection, either double click it; or move the highlight bar to it, then press **[Enter]**. An icon appears before the selected choice to indicate which one it is. The settings are explained in the following table:

Setting	Function
OSD HOTKEY	Selects which hotkey activates the OSD function: [Scroll Lock] [Scroll Lock] or [Ctrl] [Ctrl]. Since the [Ctrl] key combination may conflict with programs running on the computers, the default is the [Scroll Lock] combination.
PORT ID DISPLAY POSITION	Allows you to position where the port ID appears on the monitor. The default is the upper left corner, but you can choose to have it appear anywhere on the screen. Use the mouse or the arrow Keys plus Pg Up, Pg Dn, Home, End, and 5 (on the numeric keypad with Num Lock off), to position the port ID display, then click or press [Enter] to lock the position and return to the Set submenu. Note: The setting affects the currently selected computer. If you don't want to use the default position, you must change the setting for each computer individually.
PORT ID DISPLAY DURATION	Determines how long a port ID displays on the monitor after a port change has taken place. The choices are: User Defined – lets you select the amount of time (from 1–255 sec.); and Always On – displays the port ID at all times. If you select user defined, key in the number of seconds, then press [Enter] . The default is 3 Seconds. A setting of 0 (zero) disables this function.
PORT ID DISPLAY MODE	Selects how the port ID is displayed: the port number alone (PORT NUMBER); the port name alone (PORT NAME); or the port number plus the port name (PORT NUMBER + PORT NAME). The default is PORT NUMBER + PORT NAME).
SCAN DURATION	Determines how long the focus dwells on each port as it cycles through the selected ports in Auto Scan mode (see F7: SCAN , page 34). Key in a value from 1–255 seconds, then press [Enter] . Default is 5 seconds; a setting of 0 disables the Scan function.

(Continues on next page.)

(Continued from previous page.)

Setting	Function
SCAN/SKIP MODE	<p>Selects which computers will be accessed under Skip mode (see <i>F5: SKP</i>, page 32), and Auto Scan mode (see <i>F7: SCAN</i>, page 34). Choices are:</p> <p>ALL – All the ports which have been set Accessible (see <i>SET ACCESSIBLE PORTS</i>, page 30);</p> <p>QUICK VIEW – Only those ports which have been set Accessible and have been selected as Quick View Ports (see <i>SET QUICK VIEW PORTS</i>, page 30);</p> <p>POWERED ON – Only those ports which have been set Accessible and are Powered On;</p> <p>QUICK VIEW + POWERED ON – Only those ports which have been set Accessible and have been selected as Quick View Ports and are Powered On. The default is ALL.</p>
SCREEN BLANKER	<p>If there is no input from the console for the amount of time set with this function, the screen is blanked. Key in a value from 1–30 minutes, then press [Enter]. A setting of 0 disables this function. The default is 0 (disabled).</p>
HOTKEY COMMAND MODE	<p>Enables / Disables the Hotkey function (see <i>Keyboard Port Operation</i>, page 37), in case a conflict with programs running on the computers occurs.</p>
HOTKEY	<p>This setting selects the Hotkey invocation keys (see <i>Keyboard Port Operation</i>, page 37). Choices are [NUM LOCK] + [-], or [CTRL] + [F12]. The default is [NUM LOCK] + [-].</p>

F4: ADM

F4 is an administrator only function. It allows the administrator to configure and control the overall operation of the OSD. To change a setting double click it; or use the up and down arrow keys to move the highlight bar to it, then press **[Enter]**.

After you select an item, a submenu with further choices appears. Double click the choice you want, or move the highlight bar to it, then press **[Enter]**. An icon appears before the selected choice so that you know which one it is. The settings are explained in the following table:

Setting	Function
SET USERNAME AND PASSWORD	<p>This function is used to set usernames and passwords for the administrator and users:</p> <ol style="list-style-type: none"> 1. One Administrator and four user passwords can be set. 2. After you select the administrator field or one of the user fields, a screen that allows you to key in your username and password appears. The username and password may be up to 12 characters long, and can consist of any combination of letters and numbers (A–Z, a–z, 0–9). 3. For each individual, key in the username and password, then press [Enter]. 4. To modify or delete a previous username and/or password, use the backspace key to erase individual letters or numbers.
SET LOGOUT TIMEOUT	<p>If there is no input from the console for the amount of time set with this function, the operator is automatically logged out. A login is necessary before the console can be used again.</p> <p>This enables other operators to gain access to the computers when the original operator is no longer accessing them, but has forgotten to log out. To set the timeout value, key in a number from 1–180 minutes, then press [Enter]. If the number is 0 (zero), this function is disabled. Default is 0 (disabled).</p>

(Continues on next page.)

(Continued from previous page.)

Setting	Function
EDIT PORT NAMES	<p>To help remember which computer is attached to a particular port, every port can be given a name. This function allows the administrator to create, modify, or delete port names. To edit a port name:</p> <ol style="list-style-type: none"> 1. Click the port you want, or use the navigation keys to move the highlight bar to it, then press [Enter]. 2. Key in the new port name, or modify/delete the old one. The maximum number of characters allowed for the port name is 12. Legal characters include: <ul style="list-style-type: none"> ◆ All alpha characters: A–Z* ◆ All numeric characters: 0–9 ◆ + - / : . and Space <p>*Case does not matter; the OSD displays the port name in all capitals no matter how they were keyed in.</p> 3. When you have finished editing, press [Enter] to have the change take effect. To abort the change, press [Esc].
RESTORE DEFAULT VALUES	<p>This function is used to undo all changes and return the setup to the original factory default settings (see <i>OSD Factory Default Settings</i>, page 61) – except for the <i>Names</i> settings that were assigned to the ports, which are saved.</p>
CLEAR THE NAME LIST	<p>This function clears the port name list.</p>
ACTIVATE BEEPER	<p>Choices are Y (for Yes), or N (for No). When activated, the beeper sounds whenever a port is changed, when activating the Auto Scan function (see <i>F7: SCAN</i>, page 34), or an invalid entry is made on an OSD menu. The default is Y (activated).</p>

(Continues on next page.)

(Continued from previous page.)

Setting	Function
SET QUICK VIEW PORTS	<p>This function lets the administrator select which ports to include as Quick View ports.</p> <ul style="list-style-type: none"> ◆ To select/deselect a port as a Quick View Port, use the navigation keys to move the highlight bar to it, then press the [Spacebar]. ◆ When a port has been selected as a Quick View Port, an arrowhead displays in the QV column of the LIST on the Main Screen to indicate so. When a port is deselected, the arrowhead disappears. ◆ If one of the Quick View options is chosen for the LIST view (see <i>F2: LIST</i>, page 25), only a port that has been selected here will display on the List. ◆ If one of the Quick View options is chosen for Auto Scanning (see <i>SCAN/SKIP MODE</i>, page 27), only a port that has been selected here will be Auto Scanned. <p>The default is for no ports to be selected.</p>
SET ACCESSIBLE PORTS	<p>This function allows the administrator to define user access to the computers on the installation on a port-by-port basis.</p> <p>For each user, select the target port, then press the [Spacebar] to cycle through the choices: F (Full access), V (View Only), or blank. Repeat until all access rights have been set, then press [Esc]. The default is F for all users on all ports.</p> <p>Note: A blank setting means that no access rights are granted. The port will not show up on the user's LIST on the Main Screen.</p>
RESET STATION IDS	<p>If you change the position of one of the stations in the daisy chain, the OSD settings will no longer correspond to the new situation. This function directs the OSD to rescan the station positions of the entire installation and updates the OSD so that the OSD station information corresponds to the new physical layout.</p> <p>Note: Only the station numbers get updated. Except for the port names, all administrator settings (such as Set Accessible Ports, Set Quick View Ports, etc.), for all of the computers affected by the change, have to be manually redone.</p>

(Continues on next page.)

(Continued from previous page.)

Setting	Function
SET OPERATING SYSTEM	<p>Specifies the operating platform of the computer attached to each port. For each port, press the [Spacebar] to cycle through the choices (PC, Mac, Sun, and Other). Repeat until all the ports have been set, then press [Esc]. The default is PC.</p> <p>Note: If you are installing a Sun or Mac computer, before you run it for the first time you must set the correct operating system for the port it is connected to with this function; otherwise, it will not boot.</p>
SET CAT 5 CABLE LENGTH	<p>Lets you specify how long the Cat 5 cable between the port and the KVM adapter cable is. Press [Spacebar] to cycle through the cable length settings:</p> <p>S: Short – for up to 25 m M: Medium – for between 20 and 35 m L: Long – for above 35 m</p> <p>An S, M, or L appears next to the port to indicate the choice.</p>
SET KEYBOARD LANGUAGE	<p>Sets the keyboard language layout for the computers attached to each port. Press [Spacebar] to cycle through the choices: English (US); English (UK); French; German; Japanese; Korean; Traditional Chinese; and Spanish. The default is English (US).</p>
FIRMWARE UPGRADE	<p>In order to upgrade the KH1508 / KH1516's firmware (see <i>The Firmware Upgrade Utility</i>, page 45) you must first enable <i>Firmware Upgrade</i> mode with this setting.</p> <p>When you bring up this menu, the current firmware version levels display. Select Y to enable Firmware Upgrade mode, or N to leave this menu without enabling it.</p>
ADAPTER UPGRADE	<p>In order to upgrade an adapter cables' firmware (see <i>Adapter Cable Upgrade</i>, page 51), you must first enable its Upgrade mode with this setting. Press [Spacebar] to select the KVM adapter cable you want to upgrade.</p> <p>When you select a KVM adapter cable, its current firmware version levels display. Select Y to enable Firmware Upgrade mode, or N to leave this menu without enabling it.</p>

F5: SKP

This function enables you to easily skip backward or forward, switching the console focus from the currently active KVM Port to the previous or next available one.

- ◆ The selection of computers to be available for Skip mode switching is made with the *Scan/Skip* mode setting under the **F3 SET** function (see page 27).
- ◆ When you are in Skip mode, press:
 - ← To skip to the previous port in the List.
 - To skip to the next port in the List.
 - ↑ To skip to the last port of the previous station in the List.
 - ↓ To skip to the first port of the next station in the List.

Note: When you skip, you only skip to the previous or next available computer that is in the *Scan/Skip* mode selection (see page 27).

- ◆ If a port has been selected for *Scan/Skip* mode, when the focus switches to that port a left/right triangle symbol appears before its port ID display.
- ◆ While Skip mode is in effect, the console will not function normally. You must exit Skip mode in order to regain control of the console.
- ◆ To exit Skip mode, press the [Spacebar] or [Esc].

F6: BRC

F6 is an administrator only function. When this function is in effect, commands sent from the console are broadcast to all available computers on the installation.

This function is particularly useful for operations that need to be performed on multiple computers, such as performing a system wide shutdown, installing or upgrading software, etc.

BRC works in conjunction with the **F2 LIST** function. The LIST function (see page 25), is used to broaden or narrow the focus of which ports appear on the OSD Main Screen. When you broadcast a command, it is to the ports currently displayed on the OSD Main Screen.

- ♦ While BRC mode is in effect, a speaker symbol appears before the port ID display of the port that currently has the console focus.
- ♦ While BRC mode is in effect, the mouse will not function normally. You must exit BRC mode in order to regain control of the mouse.
- ♦ To exit BRC mode, invoke the OSD (with the OSD Hotkey), then click the **F6** field, or press [F6], to turn BRC mode off.

F7: SCAN

This function automatically switches among the available computers at regular intervals so that you can monitor their activity without having to take the trouble of switching manually.

- ◆ The selection of computers to be included for Auto Scanning is made with the *Scan/Skip* mode setting under the **F3 SET** function (see page 27).
- ◆ The amount of time that each port displays for is set with the *Scan Duration* setting under the **F3 SET** function (see page 26).
- ◆ As each computer is accessed, an **S** appears in front of the port ID display to indicate that it is being accessed under *Auto Scan* mode.
- ◆ While you are in Auto Scan mode, you can pause the scanning in order to keep the focus on a particular computer either by pressing **P**, or with a left click of the mouse. To resume scanning, press any key or left click again. See *Invoking Auto Scan*, page 39, for details.
- ◆ To stop scanning and stay at a particular location, press the [Spacebar] or [Esc] to exit *Auto Scan* mode. If the scanning stops on an empty port, or one where the computer is attached but is powered off, the monitor screen will be blank, and the mouse and keyboard will have no effect. Simply wait; after the *Scan Duration* time is up, the Scan function will move on to the next port.
- ◆ While Auto Scan mode is in effect, the console will not function normally. You must exit Auto Scan mode in order to regain control of the console.
- ◆ To exit Auto Scan mode, press the [Spacebar] or [Esc].

F8: LOUT

Clicking the **F8** field, or pressing [**F8**], logs you out of the OSD and blanks the console screen. This is different from simply deactivating the OSD when you are at the Main Screen by pressing [Esc].

With this function you must log in all over again to regain access to the OSD, whereas with [Esc], all you have to do to reenter the OSD is tap the OSD Hotkey.

-
- Note:**
1. When you reenter the OSD after logging out, the screen stays blank except for the OSD Main Menu. You must input your password before you can continue.
 2. If you reenter the OSD after logging out, and immediately use [Esc] to deactivate the OSD without having selected a port from the OSD menu, a Null Port message displays on the screen. The OSD hotkey will bring up the OSD Main Screen.
-

This Page Intentionally Left Blank

Chapter 5

Keyboard Port Operation

Overview

Keyboard port control allows you to provide KVM focus to a particular computer using hotkey combinations from the keyboard. The KH1508 / KH1516 provides the following hotkey port control features:

- ◆ Selecting the Active Port
- ◆ Auto Scanning
- ◆ Skip Mode Switching

Invoking Hotkey Mode

All hotkey operations begin by invoking *Hotkey* mode. Invoking Hotkey mode takes three steps:

1. Hold down the **Num Lock** key;
2. Press and release the **minus** key;
3. Release the **Num Lock** key:

[Num Lock] + [-];

Note: The minus key must be released within one half second, otherwise hotkey invocation is cancelled and it has no effect.

When Hotkey mode is active:

- ◆ The Caps Lock, and Scroll Lock LEDs flash in succession to indicate so. They stop flashing and revert to normal status when you exit Hotkey mode.
- ◆ A command line appears on the monitor screen. The command line prompt is the word *Hotkey:* in yellow text on a blue background, and displays the subsequent hotkey information that you key in.
- ◆ Ordinary keyboard and mouse functions are suspended – only hotkey compliant keystrokes (described in the sections that follow), can be input.

Pressing [Esc] exits Hotkey mode.

Selecting the Active Port

Each computer port is assigned a port ID (see *Port ID Numbering*, page 19). You can directly access any computer on the installation with a hotkey combination that specifies the port ID of the computer port that the computer is connected to. The steps involved are:

1. Invoke Hotkey mode (see page 37).
2. Key in the port ID
The port ID numbers display on the command line as you key them in. If you make a mistake, use **[Backspace]** to erase the wrong number.
3. Press **[Enter]**
After you press [Enter], the KVM focus switches to the designated computer and you automatically exit Hotkey mode.

Auto Scanning

Auto Scan automatically switches among all the active computer ports that are accessible to the currently logged on user at regular intervals, so that he can monitor their activity automatically. (See *SCAN/SKIP MODE* of the OSD **F3 SET** function, page 26 for information regarding accessible ports).

Setting the Scan Interval

The amount of time Auto Scan dwells on each port is set with the *SCAN DURATION* setting of the OSD **F3 SET** function (see page 26). You can change the scan interval before activating hotkey Auto Scanning, if you wish, with the following hotkey combination:

1. Invoke Hotkey mode (see page 37).
2. Key in **[T] [n]**
Where [T] is the letter **T**, and [n] is a number from 1–255 that represents the number of seconds for the dwell time.

The letter **T** and the numbers display on the command line as you key them in. If you make a mistake, use **[Backspace]** to erase the wrong number.
3. Press **[Enter]**
After you press [Enter], you automatically exit Hotkey mode, and are ready to invoke Auto Scanning.

Invoking Auto Scan

To start Auto Scanning, key in the following hotkey combination:

1. Invoke Hotkey mode (see page 37).
2. Press **[A]**.

After you press **A**, you automatically exit Hotkey mode, and enter Auto Scan mode, and Auto Scanning begins.

- ◆ While you are in Auto Scan mode, you can pause the scanning in order to keep the focus on a particular computer by pressing **[P]**. During the time that Auto Scanning is paused, the Command Line displays: **Auto Scan: Paused**.

Pausing when you want to keep the focus on a particular computer is more convenient than exiting Auto Scan mode because when you resume scanning, you start from where you left off. If, on the other hand, you exited and restarted, scanning would start over from the very first computer on the installation.

To resume Auto Scanning, press any key. Scanning continues from where it left off.

- ◆ While Auto Scan mode is in effect, ordinary keyboard and mouse functions are suspended - only Auto Scan mode compliant keystrokes can be input. You must exit Auto Scan mode in order to regain normal control of the console.
3. To exit Auto Scan mode press **[Esc]** or **[Spacebar]**. Auto Scanning stops when you exit Auto Scan mode.

Skip Mode

This feature allows you to switch between computers in order to monitor them manually. You can dwell on a particular port for as long or as little as you like, as opposed to Auto Scanning, which automatically switches after a fixed interval. To invoke Skip mode, key in the following hotkey combination:

1. Invoke Hotkey mode (see page 37).
2. Key in [**Arrow**]
 - ◆ Where [Arrow] refers to one of the arrow keys. After you press [Arrow], you automatically exit Hotkey mode, and enter Skip mode where you can switch ports as follows:
 - ← Skips to the first accessible previous port. (See *SCAN/SKIP MODE*, page 27, for information regarding accessible ports.)
 - Skips to the next accessible port.
 - ↑ Skips to the last accessible port of the previous station.
 - ↓ Skips to the first accessible port of the next station.
 - ◆ Once you are in Skip mode, you can keep on skipping by pressing the arrow keys. You don't need to invoke Hotkey mode again.
 - ◆ While Skip mode is in effect, ordinary keyboard and mouse functions are suspended; only Skip mode compliant keystrokes can be input. You must exit Skip mode in order to regain normal control of the console.
3. To exit Skip mode, press [**Esc**] or [**Spacebar**].

Hotkey Beeper Control

The beeper (see *ACTIVATE BEEPER*, page 29) can be hotkey toggled on and off. To toggle the beeper, key in the following hotkey combination:

1. Invoke Hotkey mode (see page 37).
2. Press [**B**]

After you press **B**, the beeper toggles on or off. The command line displays *Beeper On* or *Beeper Off* for one second; then the message disappears and you automatically exit Hotkey mode.

Hotkey Summary Table

[Num Lock] + [-] [Port ID] [Enter] or [Ctrl] + [F12] [Port ID] [Enter]	Switches access to the computer that corresponds to that port ID.
[Num Lock] + [-] [A] or [Ctrl] + [F12] [A]	Invokes Auto Scan mode.
[P]	Pauses auto scanning when in Auto Scan mode.
Left-click	
Any key	Resumes auto scanning after pausing.
[Esc]	Exits Auto Scan mode.
[Spacebar]	
Right-click	
[Num Lock] + [*] [Arrow] or [Num Lock] + [-] [Arrow]	Invokes Skip mode and Switches computer access depending on which arrow was pressed.
[←]	Skips to the first accessible previous port.
[→]	Skips to the next accessible port.
[↑]	Skips to the last accessible port of the previous station.
[↓]	Skips to the first accessible port of the next station.
[Esc]	Exits Skip mode.
[Spacebar]	
[Num Lock] + [-] [H] or [Ctrl] + [F12] [H]	Changes the Hotkey Invocation keys from [Num Lock] + [-] to [Ctrl] + [F12] and vice versa.
[Num Lock] + [-] [T] or [Ctrl] + [F12] [T]	Changes the OSD Hotkey from [Scroll Lock] [Scroll Lock] to [Ctrl] [Ctrl] and vice versa.
[Num Lock] + [-] [F1] or [Ctrl] + [F12] [F1]	Sets the keyboard language layout of the port that has the KVM focus to Windows.
[Num Lock] + [-] [F2] or [Ctrl] + [F12] [F2]	Sets the keyboard language layout of the port that has the KVM focus to Mac.
[Num Lock] + [-] [F3] or [Ctrl] + [F12] [F3]	Sets the keyboard language layout of the port that has the KVM focus to Sun.
[Num Lock] + [-] [R] [Enter] or [Ctrl] + [F12] [R] [Enter]	Resets the switch to the default settings.
[Num Lock] + [-] [B] or [Ctrl] + [F12] [B]	Toggles the Beeper On or Off.









This Page Intentionally Left Blank

Chapter 6

Keyboard Emulation

Mac Keyboard







The PC compatible (101/104 key) keyboard can emulate the functions of the Mac keyboard. The emulation mappings are listed in the table below.

PC Keyboard	Mac Keyboard
[Shift]	Shift
[Ctrl]	Ctrl
	
[Ctrl] [1]	
[Ctrl] [2]	
[Ctrl] [3]	
[Ctrl] [4]	
[Alt]	Alt
[Print Screen]	F13
[Scroll Lock]	F14
	=
[Enter]	Return
[Backspace]	Delete
[Insert]	Help
[Ctrl] 	F15

Note: When using key combinations, press and release the first key (Ctrl), then press and release the activation key.

Sun Keyboard

The PC compatible (101/104 key) keyboard can emulate the functions of the Sun keyboard when the Control key [Ctrl] is used in conjunction with other keys. The corresponding functions are shown in the table below.

PC Keyboard	Sun Keyboard
[Ctrl] [T]	Stop
[Ctrl] [F2]	Again
[Ctrl] [F3]	Props
[Ctrl] [F4]	Undo
[Ctrl] [F5]	Front
[Ctrl] [F6]	Copy
[Ctrl] [F7]	Open
[Ctrl] [F8]	Paste
[Ctrl] [F9]	Find
[Ctrl] [F10]	Cut
[Ctrl] [1]	
[Ctrl] [2]	
[Ctrl] [3]	
[Ctrl] [4]	
[Ctrl] [H]	Help
	Compose
	

Note: When using key combinations, press and release the first key (Ctrl), then press and release the activation key.

Chapter 7

The Firmware Upgrade Utility

Introduction

As new firmware revisions become available for the KH1508 / KH1516, new firmware upgrade packages are posted on our web site. Check the website regularly to find the latest packages and information relating to them.

Before You Begin

To prepare for the firmware upgrade, do the following:

1. From a computer that is not part of your KVM installation go to our Internet support site and choose the model name that relates to your device to get a list of available Firmware Upgrade Packages.
2. Choose the Firmware Upgrade Package you want to install (usually the most recent), and download it to your computer.
3. Use the firmware upgrade cable (provided with this unit), to connect a COM port on your computer to the firmware upgrade port of your device.

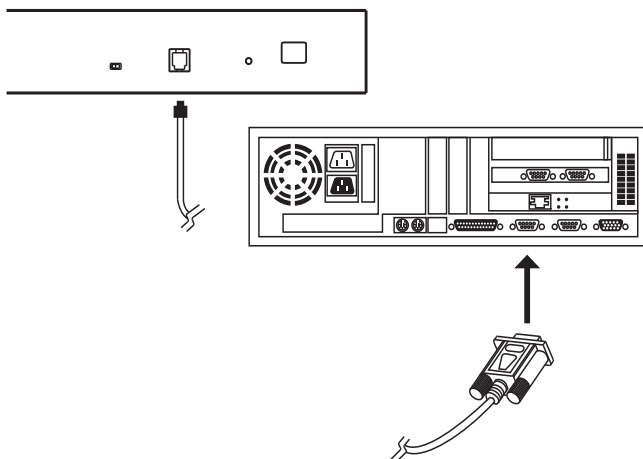

Note: On a daisy chained installation, connect the cable to the first station (master) unit. The chained stations (slaves) will receive the upgrade via the daisy chain cables.

4. Shut down all of the computers, but not the stations, on your KVM installation.
5. From your KVM switch console, bring up the OSD (see page 21) and select the **F4ADM** function.
6. Scroll down to *FIRMWARE UPGRADE*. Press **[Enter]**, then press **[Y]** to invoke Firmware Upgrade mode. (see page 31.) For your reference, the current firmware upgrade version displays on the screen.

Performing the Upgrade

Starting the Upgrade

To upgrade your firmware:

1. Run the downloaded Firmware Upgrade Package file, either by double clicking the file icon, or by opening a command line and keying in the full path to it.

The Firmware Upgrade Utility *Welcome* screen appears:

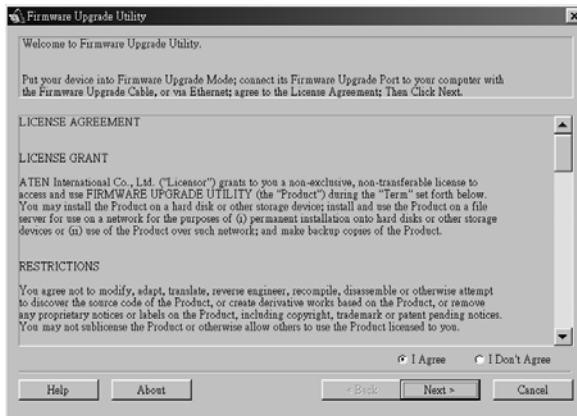

2. Read and *Agree* to the License Agreement (enable the I Agree radio button).

3. Click **Next** to continue. The Firmware Upgrade Utility main screen appears:

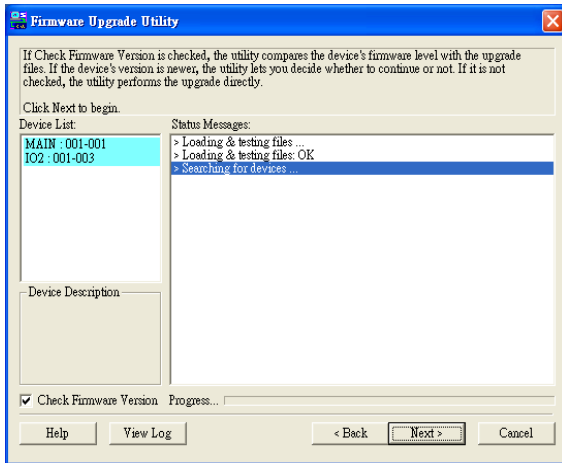

The Utility inspects your installation. All the devices capable of being upgraded by the package are listed in the *Device List* panel.

(Continues on next page.)

4. After you have made your selection(s), click **Next** to perform the upgrade.
- ◆ If you enabled *Check Firmware Version*, the utility compares the device's firmware level with that of the upgrade files. If it finds that the device's version is higher than the upgrade version, it brings up a dialog box informing you of the situation and gives you the option to continue or cancel:

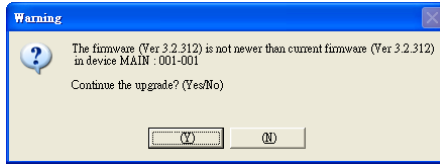

If you didn't enable *Check Firmware Version*, the utility installs the upgrade files without checking whether they are a higher level, or not.

- ◆ As the upgrade proceeds status messages appear in the *Status Messages* panel, and the progress toward completion is shown on the *Progress* bar.
- ◆ To abort the upgrade procedure before it completes, click **Cancel**.

If you cancel before completion, a dialog box appears warning you that quitting at this point may cause the device's firmware to be lost, and you are given the option to proceed or abort the cancel operation.

To recover from a "lost firmware" situation, see *Firmware Upgrade Recovery*, page 50.

Upgrade Succeeded

After the upgrade has completed, a screen appears to inform you that the procedure was successful:

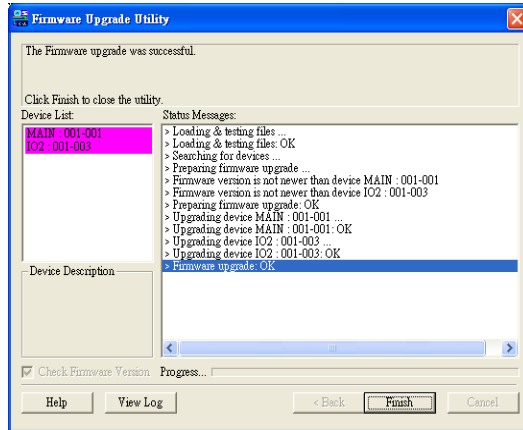

Click **Finish** to close the Firmware Upgrade Utility.

Upgrade Failed

If the upgrade failed to complete successfully a dialog box appears asking if you want to retry. Click **Yes** to retry. If you click **No**, the *Upgrade Failed* screen appears:

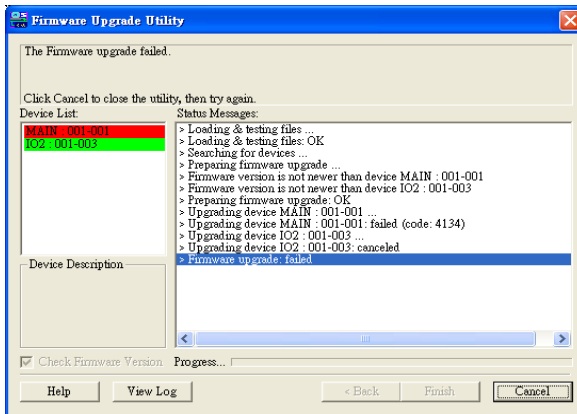

Click **Cancel** to close the Firmware Upgrade Utility. See the next section, *Firmware Upgrade Recovery*, for how to proceed.

Firmware Upgrade Recovery

There are basically four conditions that call for firmware upgrade recovery:

- ◆ When the unit's firmware becomes corrupted for some reason and you are unable to operate it.
- ◆ When you invoke Firmware Upgrade mode (see *FIRMWARE UPGRADE*, page 31), but decide not to proceed with the upgrade.
- ◆ When a firmware upgrade procedure is interrupted.
- ◆ When a firmware upgrade procedure fails.

To perform a firmware upgrade recovery, do the following:

1. Slide the *Firmware Upgrade Recovery Switch* (see page 7) to the **Recover** position.
2. Power off and restart the switch according to the instructions given in the *Powering Off and Restarting* section (see page 19).
3. Repeat the upgrade procedure starting with *Performing the Upgrade*, page 46.
4. When the upgrade ends, power off the switch
5. Slide the *Firmware Upgrade Recovery Switch* back to the **Normal** position.
6. Repeat Step 2.

Note: If one of the child units fails to upgrade successfully, unchain it from the installation and perform the recovery and upgrade operation on it independently. After it has been successfully upgraded, plug it back into the chain

Adapter Cable Upgrade

Introduction

The firmware for the KA9520, KA9570, and KA9130 KVM Adapter Cables can also be upgraded. Check the web site regularly to find the latest packages and information relating to them.

-
- Note:** 1. A single upgrade package contains the upgrade files for all three KVM Adapter Cables.
2. KVM Adapter Cables are referred to as *I/O Modules* in some dialog boxes.
-

Before You Begin

To prepare for the firmware upgrade, do the following:

1. From a computer that is not part of your KVM installation go to our Internet support site and choose the model name that relates to your device to get a list of available Firmware Upgrade Packages.
2. Choose the Firmware Upgrade Package you want to install (usually the most recent), and download it to your computer.
3. Use the *Firmware Upgrade Cable* (provided with this unit), to connect a COM port on your computer to the *Firmware Upgrade Port* of the KH1508 / KH1516.
4. From your KVM switch console, bring up the OSD (see page 21) and select the **F4ADM** function.
5. Scroll down to *ADAPTER UPGRADE*. Press **[Enter]**.
6. In the screen that comes up, press **[Y]** to invoke Upgrade mode.

-
- Note:** 1. A message appears reminding you to connect an adapter cable. The message appears even if you have adapter cables connected. If all the adapter cables you want to upgrade have already been connected, simply ignore the message.
2. The upgrade takes place via the Cat 5 cable that connects the adapter cable to the KVM switch, so there is no firmware upgrade cable to attach.
 3. All the connected adapter cables get upgraded during a single upgrade session.
-

Performing the Upgrade

Starting the Upgrade

To upgrade your firmware:

1. Run the downloaded Firmware Upgrade Package file - either by double clicking the file icon, or by opening a command line and keying in the full path to it.

The Firmware Upgrade Utility *Welcome* screen appears (see page 46).

2. Read and *Agree* to the License Agreement (enable the I Agree radio button), then click **Next** to continue. The Firmware Upgrade Utility main screen appears:

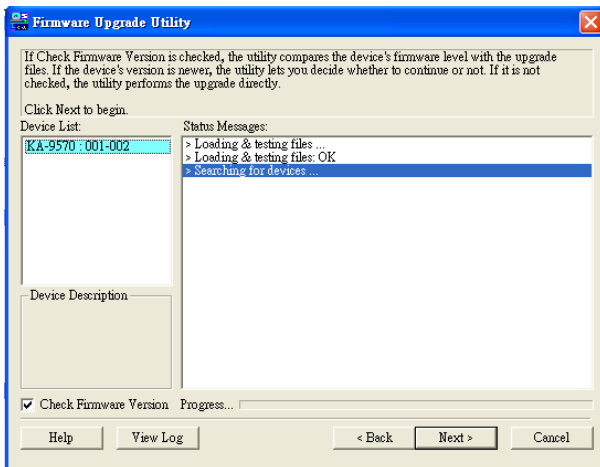

The utility inspects your installation. All the devices capable of being upgraded by the package are listed in the *Device List* panel.

3. After all the devices have been listed, click **Next** to perform the upgrade. If you enabled *Check Firmware Version*, the utility compares the device's firmware level with that of the upgrade files. If it finds that the device's version is higher than the upgrade version, it brings up a dialog box informing you of the situation and gives you the option to continue or cancel.

If you didn't enable *Check Firmware Version*, the utility installs the upgrade files without checking whether they are a higher level, or not.

As the upgrade proceeds status messages appear in the status messages panel, and the progress toward completion is shown on the *Progress* bar.

Upgrade Succeeded

After the upgrade has completed, a screen appears to inform you that the procedure was successful:

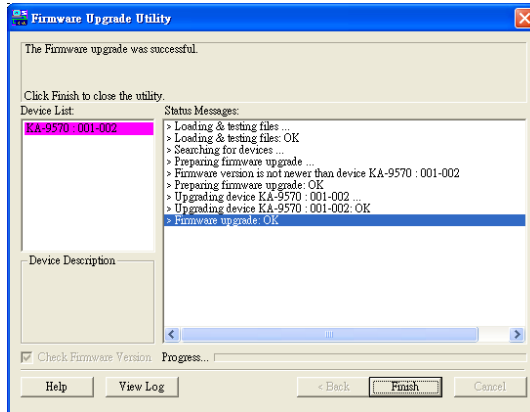

Click **Finish** to close the Firmware Upgrade Utility.

Note: At the completion of the upgrade the KH1508 / KH1516 restarts.

Adapter Cable Firmware Upgrade Recovery

There are basically four conditions that call for an adapter cable firmware upgrade recovery:

- ◆ When the unit's firmware becomes corrupted for some reason and you are unable to operate it.
- ◆ When you invoke Adapter Upgrade mode (see *ADAPTER UPGRADE*, page 31), but decide not to proceed with the upgrade.
- ◆ When a firmware upgrade procedure is interrupted.
- ◆ When a firmware upgrade procedure fails.

To perform an adapter cable firmware upgrade recovery, do the following:

1. Unplug the adapter cable from the computer it is connected to.
2. Slide its *Firmware Upgrade Recovery Switch* (located next to the Cat 5 connector) to the **Recover** position.
3. Plug the adapter cable back into the computer.
4. From your KVM switch console, bring up the OSD (see page 21) and select the **F4ADM** function.
5. Scroll down to *ADAPTER UPGRADE*. Press [**Enter**].
6. Press [**Y**] to invoke Upgrade mode.
7. Proceed with the firmware upgrade as described in *Performing the Upgrade*, starting on page 52.
8. After the upgrade completes and the switch restarts, unplug the adapter cable from the computer and slide the *Firmware Upgrade Recovery Switch* back to the **Normal** position.
9. Plug the adapter cable back into the computer.

Safety Instructions

General

- ◆ Read all of these instructions. Save them for future reference.
- ◆ Follow all warnings and instructions marked on the device.
- ◆ Do not place the device on any unstable surface (cart, stand, table, etc.). If the device falls, serious damage will result.
- ◆ Do not use the device near water.
- ◆ Do not place the device near, or over, radiators or heat registers.
- ◆ The device cabinet is provided with slots and openings to allow for adequate ventilation. To ensure reliable operation, and to protect against overheating, these openings must never be blocked or covered.
- ◆ The device should never be placed on a soft surface (bed, sofa, rug, etc.) as this will block its ventilation openings. Likewise, the device should not be placed in a built in enclosure unless adequate ventilation has been provided.
- ◆ Never spill liquid of any kind on the device.
- ◆ Unplug the device from the wall outlet before cleaning. Do not use liquid or aerosol cleaners. Use a damp cloth for cleaning.
- ◆ The device should be operated from the type of power source indicated on the marking label. If you are not sure of the type of power available, consult your dealer or local power company.
- ◆ The device is designed for IT power distribution systems with 230V phase-to-phase voltage.
- ◆ To prevent damage to your installation it is important that all devices are properly grounded.
- ◆ The device is equipped with a 3-wire grounding type plug. This is a safety feature. If you are unable to insert the plug into the outlet, contact your electrician to replace your obsolete outlet. Do not attempt to defeat the purpose of the grounding-type plug. Always follow your local/national wiring codes.

(Continues on next page.)

(Continued from previous page.)

- ◆ Do not allow anything to rest on the power cord or cables. Route the power cord and cables so that they cannot be stepped on or tripped over.
- ◆ If an extension cord is used with this device make sure that the total of the ampere ratings of all products used on this cord does not exceed the extension cord ampere rating. Make sure that the total of all products plugged into the wall outlet does not exceed 15 amperes.
- ◆ To help protect your system from sudden, transient increases and decreases in electrical power, use a surge suppressor, line conditioner, or uninterruptible power supply (UPS).
- ◆ Position system cables and power cables carefully; Be sure that nothing rests on any cables.
- ◆ Never push objects of any kind into or through cabinet slots. They may touch dangerous voltage points or short out parts resulting in a risk of fire or electrical shock.
- ◆ Do not attempt to service the device yourself. Refer all servicing to qualified service personnel.
- ◆ If the following conditions occur, unplug the device from the wall outlet and bring it to qualified service personnel for repair.
 - ◆ The power cord or plug has become damaged or frayed.
 - ◆ Liquid has been spilled into the device.
 - ◆ The device has been exposed to rain or water.
 - ◆ The device has been dropped, or the cabinet has been damaged.
 - ◆ The device exhibits a distinct change in performance, indicating a need for service.
 - ◆ The device does not operate normally when the operating instructions are followed.
- ◆ Only adjust those controls that are covered in the operating instructions. Improper adjustment of other controls may result in damage that will require extensive work by a qualified technician to repair.
- ◆ Do not connect the RJ-11 connector marked “UPGRADE” to a public telecommunication network.

Rack Mounting

- ◆ Before working on the rack, make sure that the stabilizers are secured to the rack, extended to the floor, and that the full weight of the rack rests on the floor. Install front and side stabilizers on a single rack or front stabilizers for joined multiple racks before working on the rack.
- ◆ Always load the rack from the bottom up, and load the heaviest item in the rack first.
- ◆ Make sure that the rack is level and stable before extending a device from the rack.
- ◆ Use caution when pressing the device rail release latches and sliding a device into or out of a rack; the slide rails can pinch your fingers.
- ◆ After a device is inserted into the rack, carefully extend the rail into a locking position, and then slide the device into the rack.
- ◆ Do not overload the AC supply branch circuit that provides power to the rack. The total rack load should not exceed 80 percent of the branch circuit rating.
- ◆ Make sure that all equipment used on the rack – including power strips and other electrical connectors – is properly grounded.
- ◆ Ensure that proper airflow is provided to devices in the rack.
- ◆ Ensure that the operating ambient temperature of the rack environment does not exceed the maximum ambient temperature specified for the equipment by the manufacturer
- ◆ Do not step on or stand on any device when servicing other devices in a rack.

Technical Support

Technical support is available both by email and online (with a browser over the web):

International

Email Support		support@aten.com
Online Support	Technical Support	http://support.aten.com
	Troubleshooting Documentation Software Updates	http://www.aten.com
Telephone Support		886-2-8692-6959

North America

Email Support		ATEN TECH	support@aten-usa.com
		ATEN NJ	sales@aten.com
Online Support	Technical Support	ATEN TECH	http://www.aten-usa.com/support
		ATEN NJ	http://support.aten.com
	Troubleshooting Documentation Software Updates	ATEN TECH	http://www.aten-usa.com
		ATEN NJ	http://www.aten.com
Telephone Support		ATEN TECH	1-888-999-ATEN
		ATEN NJ	1-732-356-1703

When you contact us, please have the following information ready beforehand:

- ◆ Product model number, serial number, and date of purchase.
- ◆ Your computer configuration, including operating system, revision level, expansion cards, and software.
- ◆ Any error messages displayed at the time the error occurred.
- ◆ The sequence of operations that led up to the error.
- ◆ Any other information you feel may be of help.

Specifications

Function		KH1508	KH1516	
Computer Connections	Direct	8	16	
	Max.	256 (via daisy chain)	512 (via daisy chain)	
Port Selection		OSD (on-screen display); Hotkeys Pushbutton Switches		
Connectors	Console	KB	1 x 6-pin Mini-DIN F (Purple)	
		Video	1 x HDB-15 F	
		Mouse	1 x 6-pin Mini-DIN F (Green)	
	KVM Ports		8 x RJ-45	16 x RJ-45
	Daisy Chain		1 x DB-25 F; 1 x DB-25 M	
	F/W Upgrade		1 x RJ-11	
	Power		3-Prong AC socket	
Switches	Port Selection	8 x Pushbutton	16 x Pushbutton	
	Reset	1 x Semi-recessed pushbutton		
	F/W Upgrade	1 x Slide		
	Power	1 x Rocker		
LEDs	On Line	8 (Green)	16 (Green)	
	Selected	8 (Orange)	16 (Orange)	
	Power	1 (Blue)		
	Station ID	2 x 7-segment (Orange)		
I/P Rating		AC 100–240 V; 50/60 Hz		
Power Consumption		15.5 W	15.7 W	
Emulation	Keyboard / Mouse	PS/2; USB (PC, Mac Sun); Serial		
Scan Interval		1–255 sec.		
Video		1600 x 1200 @ 60 Hz (30 m); 1280 x 1024 @ 60 Hz (40 m); DDC2B		
Environment	Operating Temp.	0–40° C		
	Storage Temp.	-20–60° C		
	Humidity	0–80% RH		
Physical Properties	Housing	Metal		
	Weight	2.75 kg		
	Dimensions	43.70 x 16.10 x 4.40 cm		

Connection Tables

The following table indicates the relationship between the number of KH1508 / KH1516 units and the number of computers that they control

KH1508

No.	Computers	No.	Computers	No.	Computers	No.	Computers
1	1 - 8	9	65 - 72	17	129 - 136	25	193 - 200
2	9 - 16	10	73 - 80	18	137 - 144	26	201 - 208
3	17 - 24	11	81 - 88	19	145 - 152	27	209 - 216
4	25 - 32	12	89 - 96	20	153 - 160	28	217 - 224
5	33 - 40	13	97 - 104	21	161 - 168	29	225 - 232
6	41 - 48	14	105 - 112	22	169 - 176	30	233 - 240
7	49 - 56	15	113 - 120	23	177 - 184	31	241 - 248
8	57 - 64	16	121 - 128	24	185 - 192	32	249 - 256

KH1516

No.	Computers	No.	Computers	No.	Computers	No.	Computers
1	1 - 16	9	129 - 144	17	257 - 272	25	385 - 400
2	17 - 32	10	145 - 160	18	273 - 288	26	401 - 416
3	33 - 48	11	161 - 176	19	289 - 304	27	417 - 432
4	49 - 64	12	177 - 192	20	305 - 320	28	433 - 448
5	65 - 80	13	193 - 208	21	321 - 336	29	449 - 464
6	81 - 96	14	209 - 224	22	337 - 352	30	465 - 480
7	97 - 112	15	225 - 240	23	353 - 368	31	481 - 496
8	113 - 128	16	241 - 256	24	369 - 384	32	497 - 512

OSD Factory Default Settings

The factory default settings are as follows:

Setting	Default
OSD Hotkey	[Scroll Lock] [Scroll Lock]
Port ID Display Position	Upper Left Corner
Port ID Display Duration	3 Seconds
Port ID Display Mode	The Port Number plus the Port Name
Scan Duration	5 Seconds
Scan/Skip Mode	All
Screen Blanker	0 (Disabled)
Logout Timeout	0 (Disabled)
Beeper	Y (Activated)
Accessible Ports	F (Full Access) For all Users on all Ports
Hotkey Command Mode	Y (Activated)
Set Operating System	Win
Keyboard Language	Auto
Set Console Mode	0: Dual-Console
Hotkey	[Num Lock] + [-]
Restore Default Values	N
Clear the Name List	N
Reset Station IDs	Y
Firmware Upgrade	N

Administrator Login Failure

If you are unable to perform an Administrator login (because the Username and Password information has become corrupted or you have forgotten it, for example) you can clear the login information with the following procedure:

1. Power off the KH1508 / KH1516 and remove its housing.
2. Short the jumper labeled **J8**.

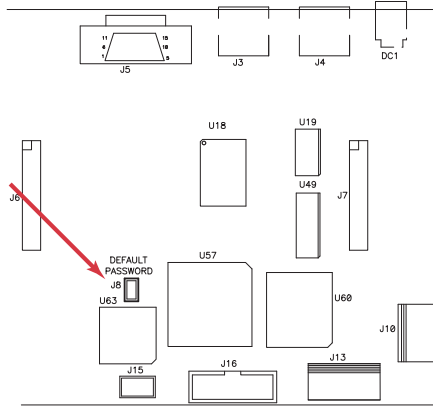

3. Power on the switch.
The on screen display will show a message informing you that the password information has been cleared.
4. Power off the switch.
5. Remove the jumper cap from **J8**.
6. Close the housing and start the KH1508 / KH1516 back up.

After you start back up, you can use the default Username and Password (see *OSD Overview*, page 21) to log in.

Troubleshooting

Overview

Operation problems can be due to a variety of causes. The first step in solving them is to make sure that all cables are securely attached and seated completely in their sockets.

In addition, updating the product's firmware may solve problems that have been discovered and resolved since the prior version was released. If your product is not running the latest firmware version, we strongly recommend that you upgrade. See *The Firmware Upgrade Utility*, page 45, for upgrade details.

Symptom	Action
Mouse and/or Keyboard not responding.	The mouse and/or keyboard need to be reset. Unplug the cable(s) from the console port(s), then plug it (them) back in.
All Station IDs display as 01.	Station 1 suddenly lost its power. Wait a few seconds for the system to reinitialize the station sequence and display the proper IDs.
My OSD looks different from the OSD screenshot shown on page 22.	See <i>User Manual Corrections</i> , page 64
The <i>OSD Operation</i> chapter refers to the F6 BRC function. My OSD doesn't have that function.	
The HOTKEY setting described on page 27 doesn't appear under my F3 SET OSD menu.	
The SET OPERATING SYSTEM, SET CAT 5 CABLE LENGTH, and SET KEYBOARD LANGUAGE settings described on page 31 don't appear under my F4 ADM OSD menu.	

User Manual Corrections

The *KH1508 / KH1516 User Manual* describes certain features that may not be available on your KVM switch. The table below lists the features in question. Please update your manual according to the information described.

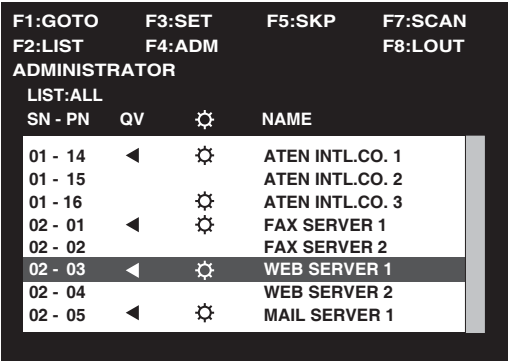
Page	Item	Correction
22	Screenshot	<p>If your OSD does not have the F6 BRC function, replace the OSD screenshot shown on page 22 with the one below:</p> 
	Note # 1	If your OSD does not have the F6 BRC function, ignore the reference to the F6 function shown in the note.
23	OSD Navigation: Bullet 3	If your OSD does not show a tree view format, it uses a Station Number – Port Number (SN – PN) format – like the one in the screenshot above.
27	HOTKEY	If there is no HOTKEY entry in your F3 SET menu, ignore the HOTKEY reference in the table on this page.
31	SET OPERATING SYSTEM	If these functions do not appear as separate entries on the F4 ADM menu, they can be found under the <i>PORT SETTINGS</i> entry of the F4 ADM menu.
	SET CAT 5 CABLE LENGTH	
	SET KEYBOARD LANGUAGE	
33	F6 BRC Function	If your OSD does not have the F6 BRC function, ignore the reference to the F6 function on this page.

Limited Warranty

ALTUSEN warrants this product against defects in material or workmanship for a period of one (1) year from the date of purchase. If this product proves to be defective, contact ALTUSEN's support department for repair or replacement of your unit. ALTUSEN will not issue a refund. Return requests can not be processed without the original proof of purchase.

When returning the product, you must ship the product in its original packaging or packaging that gives an equal degree of protection. Include your proof of purchase in the packaging and the RMA number clearly marked on the outside of the package.

This warranty becomes invalid if the factory-supplied serial number has been removed or altered on the product.

This warranty does not cover cosmetic damage or damage due to acts of God, accident, misuse, abuse, negligence or modification of any part of the product. This warranty does not cover damage due to improper operation or maintenance, connection to improper equipment, or attempted repair by anyone other than ALTUSEN. This warranty does not cover products sold AS IS or WITH FAULTS.

IN NO EVENT SHALL ALTUSEN'S LIABILITY EXCEED THE PRICE PAID FOR THE PRODUCT. FURTHER, ALTUSEN SHALL NOT BE RESPONSIBLE FOR DIRECT, INDIRECT, SPECIAL, INCIDENTAL OR CONSEQUENTIAL DAMAGES RESULTING FROM THE USE OF THE PRODUCT, ITS ACCOMPANYING SOFTWARE, OR ITS DOCUMENTATION. ALTUSEN SHALL NOT IN ANY WAY BE RESPONSIBLE FOR, WITHOUT LIMITATION, LOSS OF DATA, LOSS OF PROFITS, DOWNTIME, GOODWILL, DAMAGE OR REPLACEMENT OF EQUIPMENT OR PROPERTY, AND ANY EXPENSES FROM RECOVERY, PROGRAMMING, AND REPRODUCTION OF ANY PROGRAM OR DATA.

ALTUSEN makes no warranty or representation, expressed, implied, or statutory with respect to its products, contents or use of this documentation and all accompanying software, and specifically disclaims its quality, performance, merchantability, or fitness for any particular purpose.

ALTUSEN reserves the right to revise or update its product, software or documentation without obligation to notify any individual or entity of such revisions, or update.

For details about extended warranties, please contact one of our dedicated value added resellers.

This Page Intentionally Left Blank

Index

A

- Adapter cable installation, 14
- Administrator Login Failure, 62
- Auto Scanning, 26, 38
 - Invoking Auto Scan, 39
 - Pausing Auto Scan, 39
 - Setting the Scan Interval, 38
 - Stopping, 39

B

- Beeper
 - Hotkey Control, 40

C

- Components
 - Front View, 6
 - Rear View, 8
- Connection Tables, 59
- console modules, 9

D

- Daisy Chaining, 15

F

- Factory Default Settings, 61
- Features, 3
- Firmware upgrade, 45
 - cable, 45, 51
 - port, 45, 51
 - recovery, 50, 54
- Firmware upgrade mode
 - invoking, 46
- Front View, 6

H

- Hardware Setup, 9

Hot Plugging

- Stations, 18

Hotkey

- Beeper Control, 40
- Port Control, 37
- Selecting the Active Port, 38
- Summary Table, 41

Hotkey Mode

- auto scanning, 38
- exiting, 37
- invoking, 37

I

Installation

- daisy chaining, 15
- Single Station, 12
- Invoking Hotkey Mode, 37

K

Keyboard Emulation

- Mac, 43
- Sun, 44

Keyboard port control, 37

KH1508

- Front View, 6
- Rear View, 8

KH1516

- Front View, 6
- Rear View, 8

KVM adapter cables, 9

KVM adapter installation, 14

L

LEDs

- Port, 7
- Station ID, 7

O

Online

Registration, iii

OSD

Factory Default Settings, 61

Functions, 24

Hotkey, 21

Main Screen Headings, 23

Navigation, 23

Overview, 21

Password, 21

P

Password, 21

Port

LEDs, 7

Selection, 17

Port ID

Numbering, 19

Powering Off and Restarting, 19

R

Rack Mounting, 11

Rear View, 8

Requirements

Computer, 4

Console, 4

KVM Adapter Cables, 4

Operating Systems, 5

OS Support, 5

Reset Switch, 7

RoHS, ii

S

Safety Instructions

General, 55

Rack Mounting, 57

Scan Duration, 26

Selecting the Active Port, 38

Setting the Auto Scan Interval, 26,
38

Setting the Scan Interval, 26

SJ/T 11364-2006, ii

Skip Mode, 40

Stacking, 10

Station ID LEDs, 7

T

Technical Support, 58

Telephone support, iii

Troubleshooting, 63

U

Upgrading the firmware, 45

User Notice, iii