



Simply Better Connections

CE770

USB KVM Extender
User Manual

Compliance Statements

FEDERAL COMMUNICATIONS COMMISSION INTERFERENCE STATEMENT

This equipment has been tested and found to comply with the limits for a Class A digital device, pursuant to Part 15 of the FCC Rules. These limits are designed to provide reasonable protection against harmful interference when the equipment is operated in a commercial environment. This equipment generates, uses, and can radiate radio frequency energy and, if not installed and used in accordance with the instruction manual, may cause harmful interference to radio communications. Operation of this equipment in a residential area is likely to cause harmful interference in which case the user will be required to correct the interference at his own expense.

The device complies with Part 15 of the FCC Rules. Operation is subject to the following two conditions: (1) this device may not cause harmful interference, and (2) this device must accept any interference received, including interference that may cause undesired operation.

FCC Caution

Any changes or modifications not expressly approved by the party responsible for compliance could void the user's authority to operate this equipment.

Warning

Operation of this equipment in a residential environment could cause radio interference.

Achtung

Der Gebrauch dieses Geräts in Wohnumgebung kann Funkstörungen verursachen.

Suggestion

Shield twisted pair (STP) cables must be used with the unit to ensure compliance with FCC & CE standards.



KCC Statement

유선 제품용 / A 급 기기 (업무용 방송 통신 기기)
이 기기는 업무용 (A 급) 전자파적합기기로서 판매자 또는 사용자는 이
점을 주의하시기 바라며, 가정 외의 지역에서 사용하는 것을 목적으로
합니다.

RoHS

This product is RoHS compliant.

User Information

Online Registration

Be sure to register your product at our online support center:

International	http://support.aten.com
North America	http://www.aten-usa.com/product_registration

Telephone Support

For telephone support, call this number:

International	886-2-8692-6959
China	86-400-810-0-810
Japan	81-3-5615-5811
Korea	82-2-467-6789
North America	1-888-999-ATEN ext 4988 1-949-428-1111

User Notice

All information, documentation, and specifications contained in this manual are subject to change without prior notification by the manufacturer. The manufacturer makes no representations or warranties, either expressed or implied, with respect to the contents hereof and specifically disclaims any warranties as to merchantability or fitness for any particular purpose. Any of the manufacturer's software described in this manual is sold or licensed *as is*. Should the programs prove defective following their purchase, the buyer (and not the manufacturer, its distributor, or its dealer), assumes the entire cost of all necessary servicing, repair and any incidental or consequential damages resulting from any defect in the software.

The manufacturer of this system is not responsible for any radio and/or TV interference caused by unauthorized modifications to this device. It is the responsibility of the user to correct such interference.

The manufacturer is not responsible for any damage incurred in the operation of this system if the correct operational voltage setting was not selected prior to operation. PLEASE VERIFY THAT THE VOLTAGE SETTING IS CORRECT BEFORE USE.

Product Information

For information about all ATEN products and how they can help you connect without limits, visit ATEN on the Web or contact an ATEN Authorized Reseller. Visit ATEN on the Web for a list of locations and telephone numbers:

International	http://www.aten.com
North America	http://www.aten-usa.com

Package Contents

Check to make sure that all the components are in working order. If you encounter any problem, please contact your dealer.

The CE770 package consists of:

- ◆ 1 CE770L USB KVM Extender (Local Unit)
- ◆ 1 CE770RQ USB KVM Extender (Remote Unit)
- ◆ 1 USB KVM cable (1.8 m)
- ◆ 2 power adapters
- ◆ 2 mounting kits
- ◆ 1 user instructions

Contents

Compliance Statements	ii
User Information	iv
Online Registration	iv
Telephone Support	iv
User Notice	iv
Product Information	v
Package Contents	vi
Contents	vii
About this Manual	ix
Conventions	x
1. Introduction	
Overview	1
Features	3
Requirements	4
Consoles	4
Computers	4
Cables	4
Operating Systems	5
Components	6
CE770L (Local Unit) Front View	6
CE770RQ (Remote Unit) Front View	7
CE770L / CE770RQ Rear View	8
Side View	8
2. Hardware Setup	
Rack Mounting	9
Installation	11
Grounding	11
Setting Up	13
Installation Diagrams	14
CE770L / CE770RQ Rear View	14
CE770L Front View	15
3. Operation	
Operating Modes	17
Mode Selection	18
Deskew and Picture Compensation	19
LED Display	20
CE770RQ (Remote Unit)	21
Hotkey Setting Mode	22
Invoking HSM	22
Alternate HSM Invocation Keys	23

Keyboard Operating Platform 23
Hotkey Summary Table 24

4. Keyboard Emulation

Mac Keyboard 25
Sun Keyboard 26

Appendix

Safety Instructions 27
 General 27
 Rack Mounting 29
Technical Support 30
 International 30
 North America 30
Specifications 31
Troubleshooting 32
 Overview 32
About SPHD Connectors 32
Limited Warranty 33

About this Manual

This User Manual is provided to help you get the most from your system. It covers all aspects of installation, configuration and operation. An overview of the information found in the manual is provided below.

Chapter 1, Introduction, introduces you to the CE770 system. Its purpose, features and benefits are presented, and its front and back panel components are described.

Chapter 2, Hardware Setup, describes the steps that are necessary to quickly and safely set up your installation.

Chapter 3, Operation, explains the fundamental concepts involved in operating the CE770.

Chapter 4, Keyboard Emulation, provides tables that list the PC to Mac and PC to Sun keyboard emulation mappings.

Appendix, provides specifications and other technical information regarding the CE770.

Note:

- ◆ Read this manual thoroughly and follow the installation and operation procedures carefully to prevent any damage to the unit or any connected devices.
 - ◆ The product may be updated, with features and functions added, improved or removed since the release of this manual. For an up-to-date user manual, visit <http://www.aten.com/global/en>
-

Conventions

This manual uses the following conventions:

- Monospaced Indicates text that you should key in.
- [] Indicates keys you should press. For example, [Enter] means to press the **Enter** key. If keys need to be chorded, they appear together in the same bracket with a plus sign between them: [Ctrl+Alt].
1. Numbered lists represent procedures with sequential steps.
- ◆ Bullet lists provide information, but do not involve sequential steps.
- > Indicates selecting the option (on a menu or dialog box, for example), that comes next. For example, Start > Run means to open the *Start* menu, and then select *Run*.
-  Indicates critical information.

Chapter 1

Introduction

Overview

The CE770 is a USB (Universal Serial Bus) based KVM Extender with Deskew function. The automatic signal compensation and RS-232 serial functionality allow access to a computer system from a remote USB console (USB keyboard, monitor, and USB mouse).

Because it allows access to a computer system from a remote console, the CE770 is perfect for use in any type of installation where you need to place the console where it is conveniently accessible, but you want the system equipment to reside in a safe location – away from the dust and dirt of the factory floor, or the harsh environmental influence of a construction site, for example. This allows users to deploy system equipment over large distances.

The CE770's automatic delay line synchronizing function (ATEN patent) corrects RGB color phase and timing errors that occur over long distance transmissions. It also enables you to manually tune the R/G/B signal settings, store the settings and retrieve them later using the memory button.

The CE770 is also useful for control and security purposes, where you can have the system unit in a secure area at the same time that you put the console in the most convenient location for user access. This is ideal for managing highly confidential data systems.

The CE770 improves on previous designs by: 1) RGB delay tuner – the CE770 supports RGB delay tuner to automatically or manually synchronize the RGB signals; 2) the addition of an RS-232 port, on both the Local and Remote Units – the RS-232 port on the Local Unit allows you to connect to a serial terminal for configuration, while the RS-232 port on the Remote Unit allows you to connect serial devices such as touchscreens and barcode scanners; 3) the addition of a dedicated KVM port section on the Local Unit so you can simply and easily include a KVM switch in your installation; 4) using inexpensive Cat 5e cable instead of bulkier, more expensive, standard cables, for a much neater, more convenient, more reliable data transfer connection; 5) its ability to sense the distance to the system and automatically adjust the gain accordingly; and 6) featuring a custom ASIC to ensure the utmost in reliability and compatibility.

Further CE770 key features are built-in 8KV/15KV ESD protection and 2KV surge protection, and color adjust picture compensation pushbuttons on the Remote Unit to adjust the picture on the remote console.

Setup is as easy as can be – simply connect the computer system box and local console to the Local CE770L Unit; run the Cat 5e cable to the Remote CE770RQ Unit (up to 300 meters away); and plug the remote console into the Remote Module.

Features

- ◆ Local and Remote Units connect at distances up to 300 m using Cat 5e cable
- ◆ Deskw Function – automatically synchronizes the time delay of RGB signals to compensate for distance
- ◆ Dual console operation – control your system from both the local and remote USB keyboard, monitor, and mouse consoles
- ◆ Built-in ASIC for greater reliability and compatibility
- ◆ Auto Signal Compensation (ASC)
- ◆ RS-232 serial ports – allow you to connect to a serial terminal, or serial devices such as touchscreens and barcode scanners
- ◆ Sun/Mac keyboard support and emulation*
- ◆ Audio Enabled – supports stereo speakers and microphone
- ◆ USB overcurrent detection and prevention
- ◆ Pushbutton operating mode selection (Local Unit only) – select between Local and Auto operating modes, with the press of a single button
- ◆ Built-in 8KV/15KV ESD protection (Contact voltage 8KV; Air voltage 15KV) and 2KV surge protection
- ◆ High resolution video – up to 1920 x 1200@60Hz (150 m); 1280 x 1024@60Hz (300 m)
- ◆ Superior Audio – no loss in audio quality at 300 m
- ◆ Supports Wide Screen formats
- ◆ Supports VGA, SVGA, SXGA (1280 x 1024), UXGA (1600 x 1200), WUXGA (1920 x 1200) and multisync monitors; local monitor supports DDC; DDC2; DDC2B
- ◆ Hot pluggable
- ◆ Rack mountable
- ◆ Easy to install – no software required – connecting cables to the devices is all it takes
- ◆ Supports Wide Screen formats **

- * 1. PC keyboard combinations emulate Sun/Mac keyboard
- 2. Sun/Mac keyboards only work with their own computers

** The EDID data for a wide-screen is sent from the local video output port. For wide-screen modes and displays connect the monitor to the local video output port or use an ATEN EDID emulator.

Requirements

Consoles

- ◆ A VGA, SVGA, SXGA, UXGA, WUXGA, or multisync monitor capable of the highest resolution that you will be using on any computer in the installation

Note: If you connect a DDC type monitor to the Local Unit, the monitor that connects to the Remote Unit must be able to support the highest video resolution that the DDC monitor can provide

- ◆ A USB keyboard

Note: You can use different brands and models of USB keyboard on the Local and Remote Units, but support for multi-function keyboards is limited to the standard 104 keys.

- ◆ A USB mouse

Note: You can use different brands and models of mouse on the Local and Remote Units, but only the left and right mouse buttons and scroll wheel features are supported. Other mouse features are not supported.

- ◆ Stereo microphone and stereo speakers (optional)

Computers

The following equipment must be installed on each computer that is to be connected to the system:

- ◆ A VGA, SVGA, SXGA, UXGA, WUXGA, or multisync card.
- ◆ USB host controller and USB Type-A port.

Cables

- ◆ For optimal signal integrity, and to simplify the layout, we strongly recommend that you use the high quality custom USB KVM Cable that is provided with this package.
- ◆ Cat 5e cable is the minimum required to connect the Local and Remote CE770 Units. Cable of a lower standard will result in degrading of the video signal. For best performance, we strongly recommend Cat 5e cable.

Operating Systems

Supported operating systems are shown in the table, below:

OS		Version
Windows		2000, XP, Vista, 7, and 10
Linux	RedHat	7.1 or higher
	SuSE	9.0 or higher
	Mandriva (Mandrake)	9.0 or higher
UNIX	FreeBSD	4.2 or higher
Novell	Netware	6.0 or higher

Components

CE770L (Local Unit) Front View

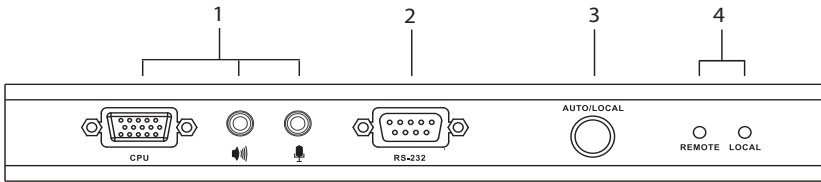

No.	Component	Description
1	KVM port section	If you are combining the CE770 with a KVM switch, the USB KVM cable that links to the respective ports on the Console section of the switch plugs into these ports.
2	RS-232 serial port	This RS-232 serial port is for connecting to a serial terminal for configuration.
3	operating mode pushbutton	This pushbutton toggles between the Operating Modes available from the Local Console: <ul style="list-style-type: none"> ◆ Local – only the Local Console can control the system(s). ◆ Auto – both the Local and Remote Consoles can control the system. <p>Note: The default operating mode is <i>Auto</i>. See <i>Operating Modes</i>, page 17, for full details.</p>
4	LEDs	The CE770L has two LEDs to indicate the operating status of the Local (CE770L) and Remote (CE770RQ) Units. See <i>LED Display</i> , page 20, for full details.

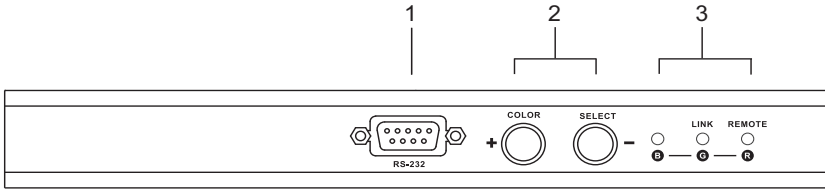
CE770RQ (Remote Unit) Front View

No.	Component	Description
1	RS-232 serial port	RS-232 serial devices – such as touchscreens or barcode scanners – plug into this port.
2	deskew and picture compensation pushbuttons	These pushbuttons adjust the video quality of the remote console. See <i>Deskew and Picture Compensation</i> , page 19 for details.
3	LEDs RGB	The CE770RQ has three LEDs to indicate the operating status. See <i>LED Display</i> , page 20.

CE770L / CE770RQ Rear View

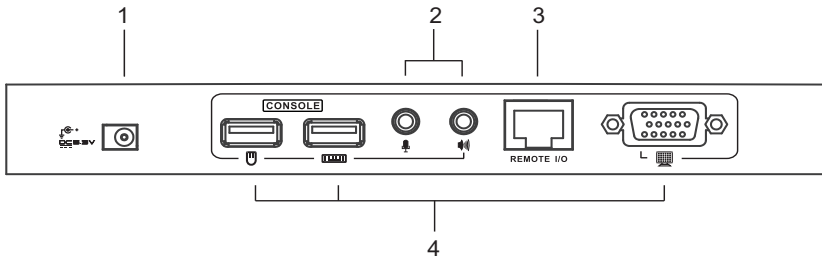

Side View

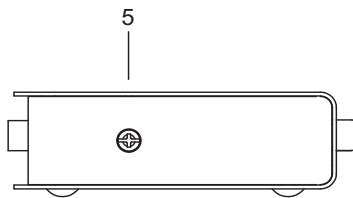

No.	Component	Description
1	power jack	The cable from the DC power adapter connects here.
2	audio ports	These mini stereo ports are for the speakers (green) and microphone (pink).
3	remote I/O	The Cat 5e cable that connects the Remote and Local Units plugs in here.
4	console ports	The Local and Remote console's keyboard, monitor, and mouse plug into these ports.
5	grounding terminal	The grounding wire (used to ground the unit) attaches here. See <i>Grounding</i> , page 11, for further details.

Chapter 2

Hardware Setup



1. Important safety information regarding the placement of this device is provided on page 27. Please review it before proceeding.
2. Make sure that the power to all devices connected to the installation are turned off. You must unplug the power cords of any computers that have the Keyboard Power On function.

Rack Mounting

For convenience and flexibility, the CE770L and CE770RQ can be mounted on system racks. To rack mount a unit do the following:

1. Using the screws provided in the rack mount kit, screw the mounting bracket into the top or bottom of the unit as show in the diagram below:

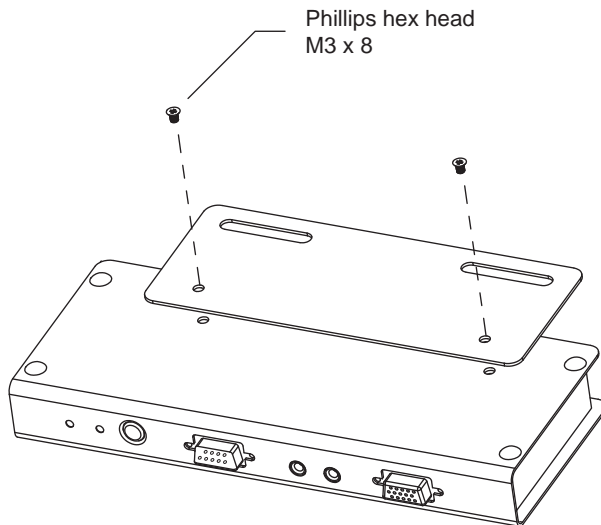

2. Screw the bracket into any convenient location on the rack.

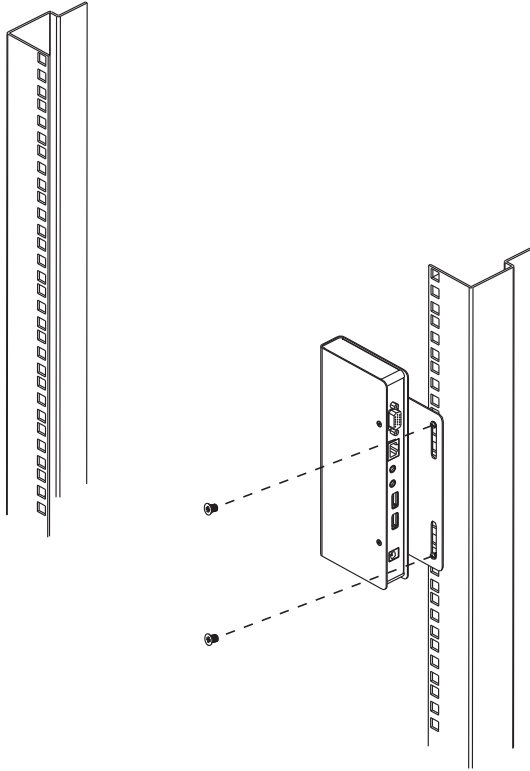

Note: These screws are not provided. We recommend that you use M5 x 12 Phillips Type I cross, recessed type screws.

Installation

Grounding

To prevent damage to your installation it is important that all devices are properly grounded.

1. Use two grounding wires to ground both units by connecting one end of a wire to the grounding terminal, and the other end of the wire to a suitable grounded object.

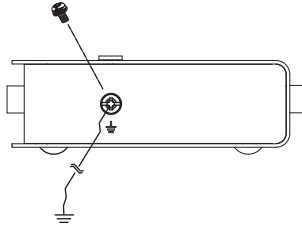

2. Be sure the computer and monitor connected to the CE770L/CE770RQ are properly grounded.

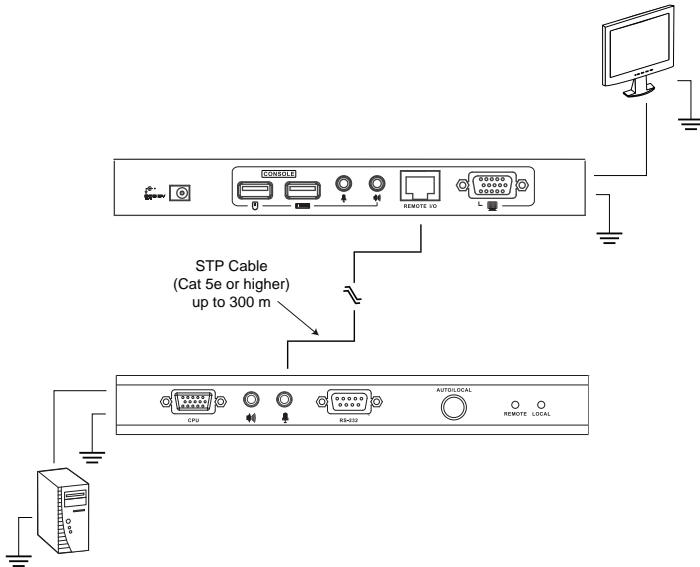

3. For increased grounding protection, use STP (shielded twisted pair) cable to connect the Local and Remote Units. There are two methods that can be used:

a) In addition to the eight paired wires, STP cable also contains a grounding wire. Solder this wire to the RJ-45 connector as shown in the diagram below:

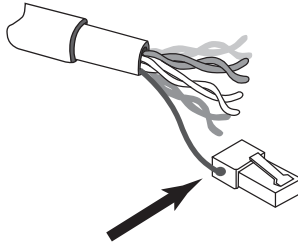

b) The second method is to use the STP cable shielding for grounding. In this case, make sure that the shielding makes tight contact with the top inside of the RJ-45 connector as shown in the diagram below:

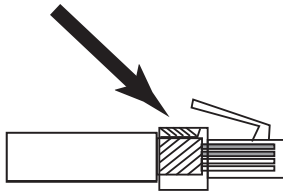

In either case, make sure that the sides of the RJ-45 connector make tight contact with the grounding contacts on the sides of the RJ-45 socket as shown in the diagram below:

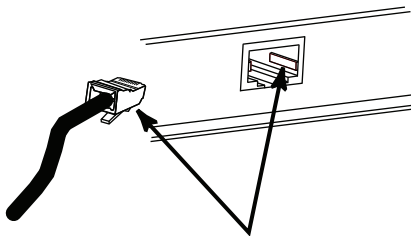

Setting Up

Setting up the CE770 USB KVM Extender system is simply a matter of plugging in the cables. Make sure that all the equipment to be connected is powered Off. Refer to the installation diagram on the following page and do the following:

1. Plug the cables from the local console devices (mouse, keyboard, monitor, microphone, speakers) into their ports in the console section on the rear of the Local Unit (CE770L). Each port is marked with an appropriate icon to indicate itself.
2. Plug the appropriate connectors on the USB KVM cable supplied with this unit into their ports on the CPU section on the front of the Local Unit (CE770L).
3. Plug the connectors on the other end of the USB KVM cable into the appropriate ports on the local computer. Each connector is marked with an appropriate icon to indicate which it is.

Note: If you are combining the CE770 with a KVM switch, the other end of the USB KVM cable plugs into the appropriate ports on the KVM switch.

4. For control of serial devices, connect the RS-232 serial port on the local unit to a serial port on the local computer.
5. Plug either end of the Cat 5e cable into the CE770L's remote I/O port. Plug the other end of the Cat 5e cable into the I/O port of the Remote Unit (CE770RQ).
6. Plug one of the power adapters (supplied with this package) into an AC source; plug the adapter's power cable into the CE770L's power jack.
7. Plug the cables from the remote console devices (mouse, keyboard, monitor, speakers, microphone), into their ports on the console side of the CE770RQ.
8. Plug the second power adapter (supplied with this package) into an AC source; plug the adapter's power cable into the CE770RQ's power jack.

Note: Hot-plugging the Cat 5e cable will automatically trigger the deskew function.

Installation Diagrams

CE770L / CE770RQ Rear View

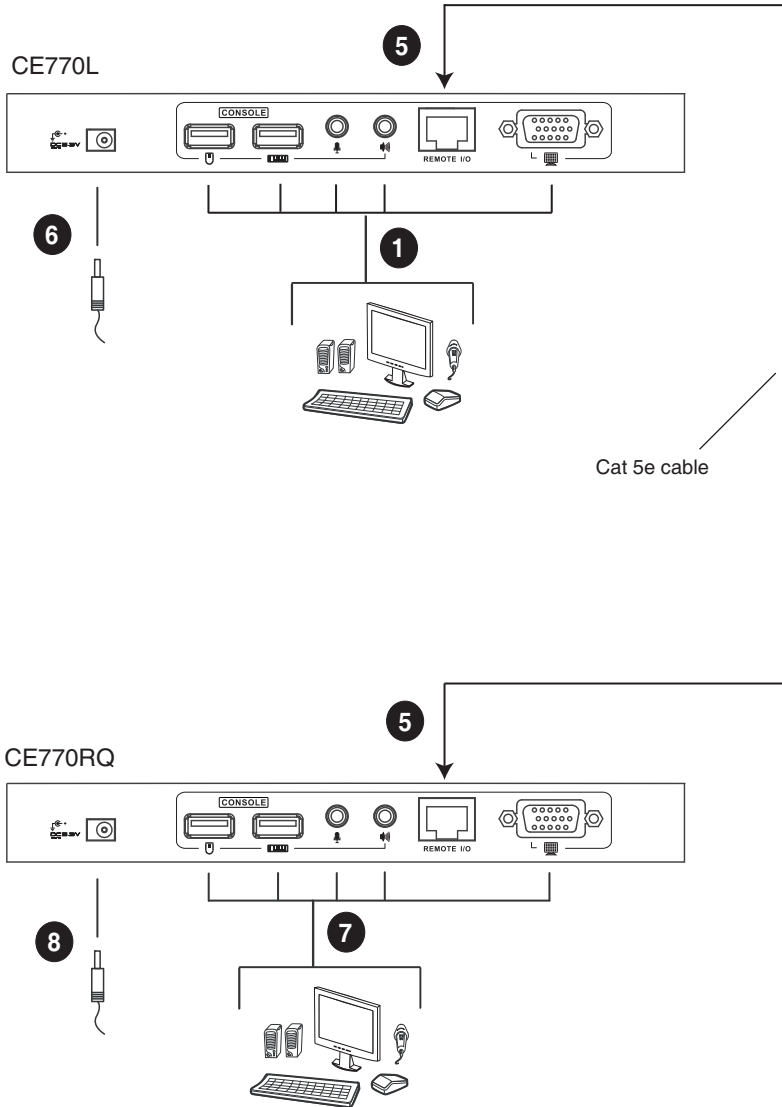

CE770L Front View

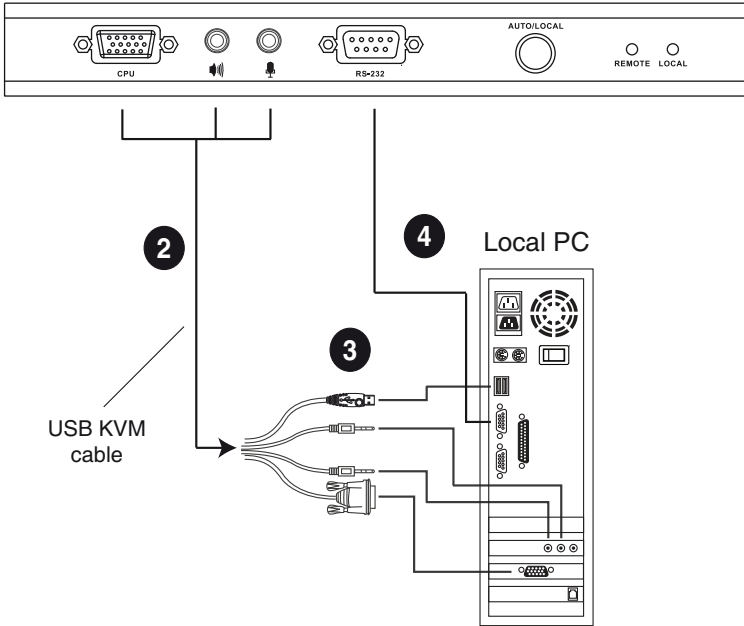

This Page Intentionally Left Blank

Chapter 3

Operation

Operating Modes

The CE770 USB KVM Extender has three operating modes: Local, Auto, and Remote, as described in the table below:

Mode	Description
Local	Only the local console has KVM access. The remote console's keyboard and mouse input is disabled.
Auto	Both the local and remote consoles can have KVM access, but not at the same time. The console without access has to wait until the console with access stops inputting data before it can gain access.
Remote	The remote console has KVM access. Remote mode can only occur when the pushbutton on the CE770L is set to <i>Auto</i> and the local console is idle. See note on page 18.

Note: The default operating mode is *Auto*.

Mode Selection

The *Operating Mode Pushbutton*, located on the CE770L's front panel, controls the operating mode of the CE770 USB KVM Extender system. Pressing the switch toggles through *Local* and *Auto* operating modes.

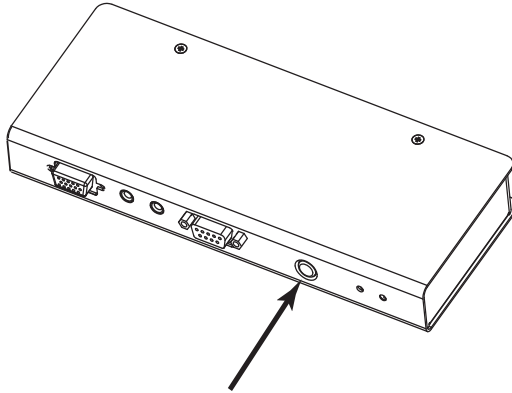

When you press the *Auto/Local* pushbutton and select **Local**, the Local LED lights solid green and the computer can only be accessed at the local console. In **Local** mode, the remote console cannot access the computer.

When you press the *Auto/Local* pushbutton and select **Auto**, the Remote and Local LEDs flash on and off alternately until the computer is accessed by the local or remote console. In **Auto** mode, both the local and remote console can access the computer on a one-at-a-time basis.

Note: Remote mode cannot be selected. The remote console can gain control only when the Operating Mode Pushbutton is toggled to *Auto* and the local console is idle. If the remote console is then idle for more than five seconds, the local console can gain access.

Deskew and Picture Compensation

The CE770RQ supports automatic and manual video adjustment:

♦ Automatic adjustment

- ♦ The CE770RQ features Auto Signal Control (ACS), which automatically adjusts video strength and save the settings.
- ♦ The CE770RQ features the Deskew function, which automatically synchronizes the time delay of RGB signals to compensate for distance. This adjustment is triggered when a Cat 5e cable is plugged into the CE770RQ.
- ♦ To reset the CE770RQ's current video compensation settings and trigger an automatic adjustment, press and hold both the **Deskew and Picture Compensation** pushbuttons (+ and -) simultaneously.

♦ Manual adjustment

To fine tune the video signal, press the **Color** button to cycle through each of the options (Red, Green, Blue, Compensation) and then adjust the settings as explained in the table below.

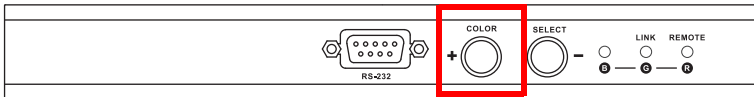

Button / Switch	Description
Color (+)	<ol style="list-style-type: none"> 1. Press and release to enter Red color mode. Use (+) and (-) to adjust. 2. Press and hold for two seconds to invoke the color scaling OSD (when no color is selected). Use the color bars to align each color. 3. Press and hold for two seconds to change the color mode or compensation (when selected). The sequence is R _ G _ B _ Video Compensation _ exit _ R... 4. Press and release to increase value (delay time / compensation) when any color / compensation is selected.
Select (-)	<ol style="list-style-type: none"> 1. Press and release to enter Red color mode. Use (+) and (-) to adjust. 2. Press and release to decrease value (delay time / compensation) when any color / compensation is selected.

LED Display

The CE770 Local and Remote Units have front panel LEDs to indicate their operating status, as shown below:

CE770L (Local Unit)

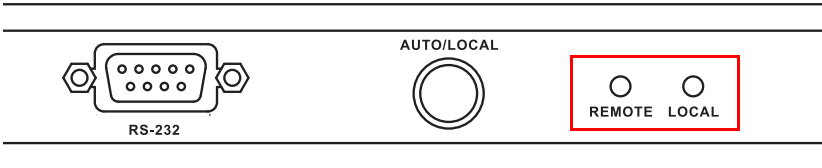

LED	Operating Mode	
	Local	Auto
Local	<ul style="list-style-type: none"> ◆ Lights solid Green when the local console is accessing the computer. ◆ In <i>Local</i> mode, the Local LED stays solid Green at all times, and the remote console cannot access the computer (see page 17). 	<ul style="list-style-type: none"> ◆ The Local LED flashes on and off alternately with the Remote LED when both consoles are waiting to access the computer (Auto Mode). ◆ The Local LED lights solid Green when a user at the local console presses a key on the keyboard or moves the mouse to indicate the computer is being accessed. ◆ When the local console is inactive for more than 4 seconds – the Local LED flashes on and off alternately with the Remote LED to indicate both consoles are waiting to access the computer.
Remote	<ul style="list-style-type: none"> ◆ Lights solid Green when the remote console is accessing the computer. 	<ul style="list-style-type: none"> ◆ The Remote LED flashes on and off alternately with the Local LED when both consoles are waiting to access the computer (Auto Mode). ◆ The Remote LED lights solid Green when a user at the remote console presses a key on the keyboard or moves the mouse to indicate the computer is being accessed. ◆ When the remote console is inactive for more than 4 seconds – the Remote LED flashes on and off alternately with the Local LED to indicate both consoles are waiting to access the computer.

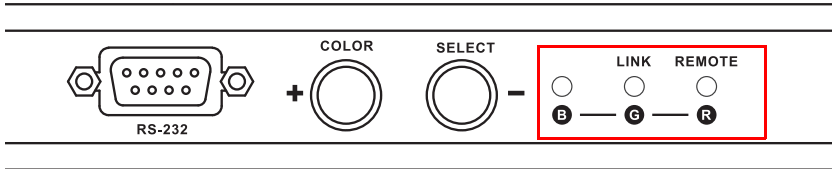
CE770RQ (Remote Unit)

LED	Indication
Link (Orange)	<ul style="list-style-type: none"> ◆ Lights Orange to indicate that the connection to the Local unit is established. ◆ Flashes Orange when there is a problem with the connection to the Local unit.
Remote (Red)	<ul style="list-style-type: none"> ◆ Lights Red to indicate that the remote console is accessing the computer. ◆ Turns off when the local console is accessing the computer. ◆ Flashes Red when Auto Mode is selected and both the local and remote consoles are waiting to access the computer.
B (Blue)	Flashes to indicate that the BLUE color is selected and the (+) and (-) pushbuttons can be used to adjust the delay time of the color BLUE.
G (Green)	Flashes Green to indicate that the GREEN color is selected and the (+) and (-) pushbuttons can be used to adjust the delay time of the color GREEN.
R (Red)	Flashes Red to indicate that the RED color is selected and the (+) and (-) pushbuttons can be used to adjust the delay time of the color RED.
R and G (Red and Green)	Both Red and Green flash to indicate that the Video Compensation is selected and the (+) and (-) pushbuttons can be used to adjust the Video Compensation setting.

Hotkey Setting Mode

The administrator and users can use hotkey combinations to configure a number of the KVM Extender's working environment parameters. All Hotkey operations begin by invoking Hotkey Setting Mode (HSM).

Invoking HSM

To invoke HSM (CE770L only), do the following:

1. Hold down **[Ctrl]**.
2. Press and release **[F12]**.
3. Release **[Ctrl]**.

Note: There is an alternative key combination to invoke HSM (see *Alternate HSM Invocation Keys*, page 23).

When Hotkey Mode is active:

- ◆ The Caps Lock, and Scroll Lock LEDs flash in succession to indicate that HSM is in effect. They stop flashing and revert to normal status when you exit HSM.
- ◆ A Command Line appears on the monitor screen. The command line prompt is the word *Hotkey:* in yellow text on a blue background. Hotkey information that you key in displays on the command line.
- ◆ Ordinary keyboard and mouse functions are suspended – only Hotkey compliant keystrokes and mouse clicks (described in the sections that follow), can be input.
- ◆ At the conclusion of some hotkey operations, you automatically exit hotkey mode. With some operations, you must exit manually. To exit HSM manually, press **[Esc]** or **[Spacebar]**.

Alternate HSM Invocation Keys

An alternate set of HSM invocation keys is provided in case the default set conflicts with programs running on the computers.

To switch to the alternate HSM invocation set, do the following:

1. Invoke HSM (see page 22).
2. Press and release [**H**].

The HSM invocation keys become the Num Lock key (instead of Ctrl) and the minus key (instead of F12).

Note: This procedure is a toggle between the two methods. To revert back to the original [Ctrl] [F12] method, invoke HSM, then press and release the **H** key again.

Keyboard Operating Platform

The CE770's default configuration is for a PC Compatible keyboard operating platform. If you have a Mac or a Sun on your installation, you can change the keyboard operating platform as follows:

3. Invoke HSM (see page 22).
4. Press and release the appropriate Function key (see table).

Key	Operation
[F1]	Sets the PC compatible keyboard operating platform for the port that currently has the KVM focus.
[F2]	Enables Mac keyboard emulation.
[F3]	Enables Sun keyboard emulation.
[F4]	Print out the KVM's current settings and quit the Setting mode.

Note: 1. The brackets indicate the keys you should press. Simply press the indicated keys – do not type the brackets.

2. After completing a setting, you automatically exit HSM.
-

Hotkey Summary Table

After invoking HSM (see page 22), key in one of the following keys to perform the corresponding function:

Key	Function
[H]	Toggles between the default ([Ctrl] [F12]) and alternate ([Num Lock] [-]) Hotkey invocation keys.
[F1]	Sets the PC compatible keyboard operating platform for the port that currently has the KVM focus.
[F2]	Sets the Mac compatible keyboard operating platform for the port that currently has the KVM focus.
[F3]	Sets the Sun keyboard operating platform for the port that currently has the KVM focus.
[F4]	Print out the KVM's current settings and quit the Setting mode.









Note: The brackets indicate the keys you should press. Simply press the indicated keys – do not type the brackets.

Chapter 4

Keyboard Emulation

Mac Keyboard







The PC compatible (101/104 key) keyboard can emulate the functions of the Mac keyboard. The emulation mappings are listed in the table below.

PC Keyboard	Mac Keyboard
[Shift]	Shift
[Ctrl]	Ctrl
	
[Ctrl] [1]	
[Ctrl] [2]	
[Ctrl] [3]	
[Ctrl] [4]	
[Alt]	Alt
[Print Screen]	F13
[Scroll Lock]	F14
	=
[Enter]	Return
[Backspace]	Delete
[Insert]	Help
[Ctrl] 	F15

Note: When using key combinations, press and release the first key (Ctrl), then press and release the activation key.

Sun Keyboard

The PC compatible (101/104 key) keyboard can emulate the functions of the Sun keyboard when the Control key [Ctrl] is used in conjunction with other keys. The corresponding functions are shown in the table below.

PC Keyboard	Sun Keyboard
[Ctrl] [T]	Stop
[Ctrl] [F2]	Again
[Ctrl] [F3]	Props
[Ctrl] [F4]	Undo
[Ctrl] [F5]	Front
[Ctrl] [F6]	Copy
[Ctrl] [F7]	Open
[Ctrl] [F8]	Paste
[Ctrl] [F9]	Find
[Ctrl] [F10]	Cut
[Ctrl] [1]	
[Ctrl] [2]	
[Ctrl] [3]	
[Ctrl] [4]	
[Ctrl] [H]	Help
	Compose
	

Note: When using key combinations, press and release the first key (Ctrl), then press and release the activation key.

Safety Instructions

General

- ◆ This device is for indoor use only.
- ◆ Read all of these instructions. Save them for future reference.
- ◆ Follow all warnings and instructions marked on the device.
- ◆ Do not place the device on any unstable surface (cart, stand, table, etc.). If the device falls, serious damage will result.
- ◆ Do not use the device near water.
- ◆ Do not place the device near, or over, radiators or heat registers.
- ◆ The device cabinet is provided with slots and openings to allow for adequate ventilation. To ensure reliable operation, and to protect against overheating, these openings must never be blocked or covered.
- ◆ The device should never be placed on a soft surface (bed, sofa, rug, etc.) as this will block its ventilation openings. Likewise, the device should not be placed in a built in enclosure unless adequate ventilation has been provided.
- ◆ Never spill liquid of any kind on the device.
- ◆ Unplug the device from the wall outlet before cleaning. Do not use liquid or aerosol cleaners. Use a damp cloth for cleaning.
- ◆ The device should be operated from the type of power source indicated on the marking label. If you are not sure of the type of power available, consult your dealer or local power company.
- ◆ Avoid circuit overloads. Before connecting equipment to a circuit, know the power supply's limit and never exceed it. Always review the electrical specifications of a circuit to ensure that you are not creating a dangerous condition or that one doesn't already exist. Circuit overloads can cause a fire and destroy equipment.
- ◆ To prevent damage to your installation, it is important that all devices are properly grounded.
- ◆ Do not allow anything to rest on the power cord or cables. Route the power cord and cables so that they cannot be stepped on or tripped over.
- ◆ Position system cables and power cables carefully; Be sure that nothing rests on any cables.

- ◆ Never push objects of any kind into or through cabinet slots. They may touch dangerous voltage points or short out parts resulting in a risk of fire or electrical shock.
- ◆ Do not attempt to service the device yourself. Refer all servicing to qualified service personnel.
- ◆ If the following conditions occur, unplug the device from the wall outlet and bring it to qualified service personnel for repair.
 - ◆ The power cord or plug has become damaged or frayed.
 - ◆ Liquid has been spilled into the device.
 - ◆ The device has been exposed to rain or water.
 - ◆ The device has been dropped, or the cabinet has been damaged.
 - ◆ The device exhibits a distinct change in performance, indicating a need for service.
 - ◆ The device does not operate normally when the operating instructions are followed.
- ◆ Only adjust those controls that are covered in the operating instructions. Improper adjustment of other controls may result in damage that will require extensive work by a qualified technician to repair.
- ◆ Do not connect the RJ-11 connector marked “UPGRADE” to a public telecommunication network.

Rack Mounting

- ◆ Before working on the rack, make sure that the stabilizers are secured to the rack, extended to the floor, and that the full weight of the rack rests on the floor. Install front and side stabilizers on a single rack or front stabilizers for joined multiple racks before working on the rack.
- ◆ Always load the rack from the bottom up, and load the heaviest item in the rack first.
- ◆ Make sure that the rack is level and stable before extending a device from the rack.
- ◆ Use caution when pressing the device rail release latches and sliding a device into or out of a rack; the slide rails can pinch your fingers.
- ◆ After a device is inserted into the rack, carefully extend the rail into a locking position, and then slide the device into the rack.
- ◆ Do not overload the AC supply branch circuit that provides power to the rack. The total rack load should not exceed 80 percent of the branch circuit rating.
- ◆ Make sure that all equipment used on the rack – including power strips and other electrical connectors – is properly grounded.
- ◆ Ensure that proper airflow is provided to devices in the rack.
- ◆ Ensure that the operating ambient temperature of the rack environment does not exceed the maximum ambient temperature specified for the equipment by the manufacturer.
- ◆ Do not step on or stand on any device when servicing other devices in a rack.

Technical Support

International

- ◆ For online technical support – including troubleshooting, documentation, and software updates: **<http://support.aten.com>**
- ◆ For telephone support, *Telephone Support*, page iv

North America

Email Support		support@aten-usa.com
Online Technical Support	Troubleshooting Documentation Software Updates	http://www.aten-usa.com/support
Telephone Support		1-888-999-ATEN ext 4988

When you contact us, please have the following information ready beforehand:

- ◆ Product model number, serial number, and date of purchase.
- ◆ Your computer configuration, including operating system, revision level, expansion cards, and software.
- ◆ Any error messages displayed at the time the error occurred.
- ◆ The sequence of operations that led up to the error.
- ◆ Any other information you feel may be of help.

Specifications

Function			CE770L	CE770RQ	
Connectors	Console Ports	Keyboard	1 x USB Type A Female (White)		
		Video	1 x HDB-15 Female (Blue)		
		Mouse	1 x USB Type A Female (White)		
		Speakers	1 x Mini Stereo Jack Female (Green)		
		Mic.	1 x Mini Stereo Jack Female (Pink)		
		RS-232	1 x DB-9 Female (Black)	1 x DB-9 Male (Black)	
	KVM Ports	KB / Video / Mouse	1 x SPHD-18 Female (Yellow)	N/A	
		Speakers	1 x Mini Stereo Jack (Green)		
		Mic.	1 x Mini Stereo Jack (Pink)		
	Unit to Unit		1 x RJ-45 Female (Black)		
Power		1 x DC Jack (Black)			
LEDs	Local		1 (Green)	N/A	
	Remote		1 (Green)	N/A	
	B		N/A	1 (Blue)	
	G	Link	N/A	1 (Orange/Green)	
	R	Remote	N/A	1 (Red)	
Pushbuttons	Operating Mode Selection		1 x Pushbutton	N/A	
	Color / Up		N/A	1 x Pushbutton	
	Select / Down		N/A	1 x Pushbutton	
Emulation	Keyboard / Mouse		USB		
Video		1920 x 1200 @ 60Hz (150 m); 1280 x 1024 @ 60Hz (300 m); DDC, DDC2, DDC2B			
Power Consumption		DC5.3V/3.5W	DC5.3V/5.1W		
Environment	Operating Temp.		0–50°C		
	Storage Temp		-20–60°C		
	Humidity		0–80% RH, Non-condensing		
Physical Properties	Housing		Metal		
	Weight		0.49 kg	0.48 kg	
	Dimensions (L x W x H)		20.0 x 8.0 x 2.5 cm		

Troubleshooting

Overview

Operation problems can be due to a variety of causes. The first step in solving them is to make sure that all cables are securely attached and seated completely in their sockets.

Problem	Action
No video	Make sure that all cables are securely plugged into their sockets.
Poor quality video	Hot-plug the Cat 5e cable again to trigger the deskew function. The video quality can be improved by using the Picture Compensation pushbuttons on the CE770RQ to increase or reduce the video signal gain. The video quality can be improved by reducing the refresh rate.

About SPHD Connectors



This product uses SPHD connectors for its KVM and/or Console ports. We have specifically modified the shape of these connectors so that only KVM cables that we have designed to work with this product can be connected.

Limited Warranty

ATEN warrants its hardware in the country of purchase against flaws in materials and workmanship for a Warranty Period of two [2] years (warranty period may vary in certain regions/countries) commencing on the date of original purchase. This warranty period includes the LCD panel of ATEN LCD KVM switches. Select products are warranted for an additional year (see *A+ Warranty* for further details). Cables and accessories are not covered by the Standard Warranty.

What is covered by the Limited Hardware Warranty

ATEN will provide a repair service, without charge, during the Warranty Period. If a product is defective, ATEN will, at its discretion, have the option to (1) repair said product with new or repaired components, or (2) replace the entire product with an identical product or with a similar product which fulfills the same function as the defective product. Replaced products assume the warranty of the original product for the remaining period or a period of 90 days, whichever is longer. When the products or components are replaced, the replacing articles shall become customer property and the replaced articles shall become the property of ATEN.

To learn more about our warranty policies, please visit our website:

<http://www.aten.com/global/en/legal/policies/warranty-policy/>

© Copyright 2022 ATEN® International Co., Ltd.
Released: 2022-07-25

ATEN and the ATEN logo are registered trademarks of ATEN International Co., Ltd. All rights reserved. All other brand names and trademarks are the registered property of their respective owners.