

# CAD Drawings

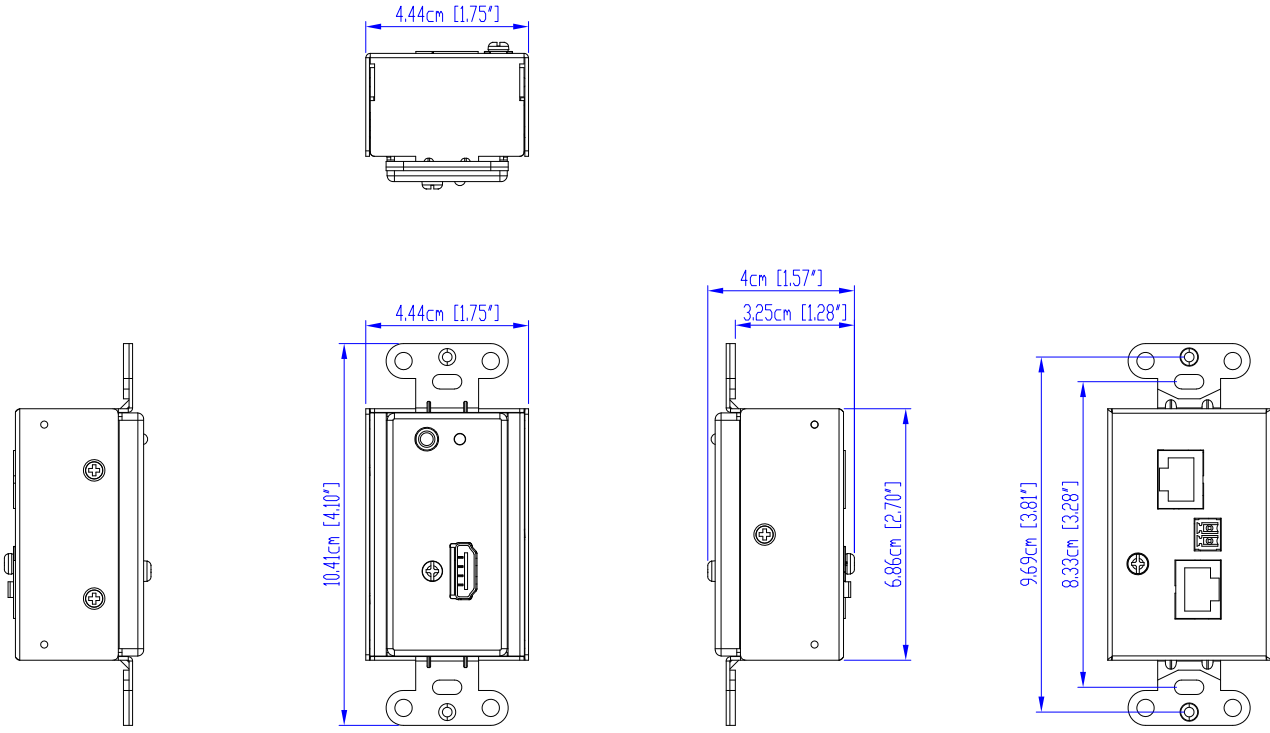

**VE806T**

# Panel Mount Cutout

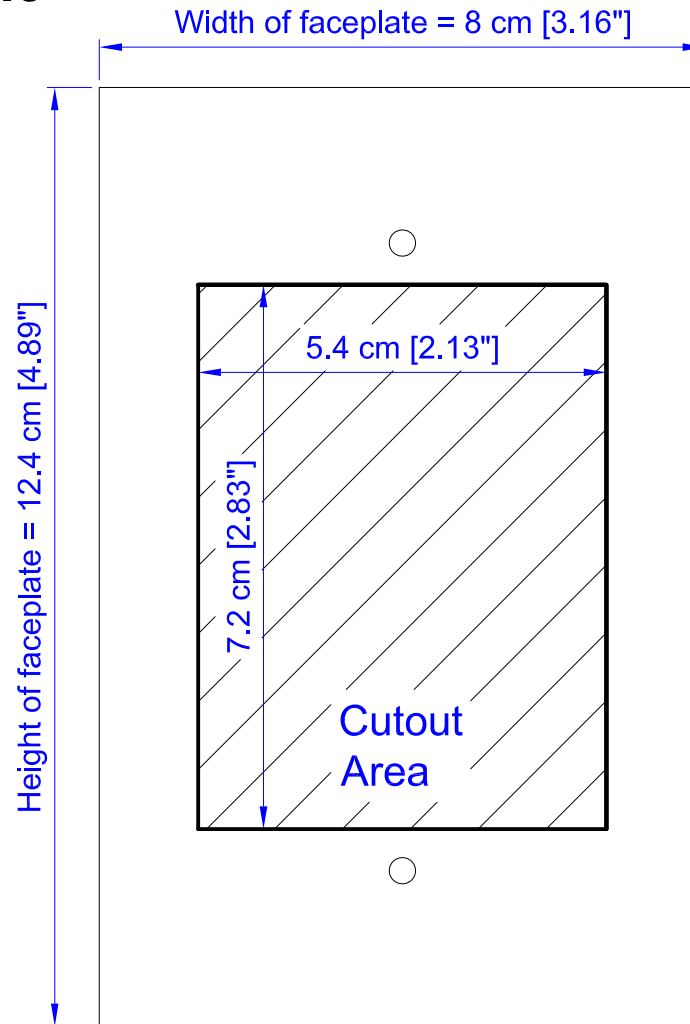

**Note:** ATEN recommends a 1-gang wall box with a depth of at least 5 cm (1.97 inches) to accommodate the connectors and cables.



**VE156/606/806**