

CAD Drawings

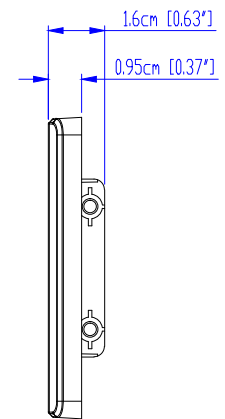

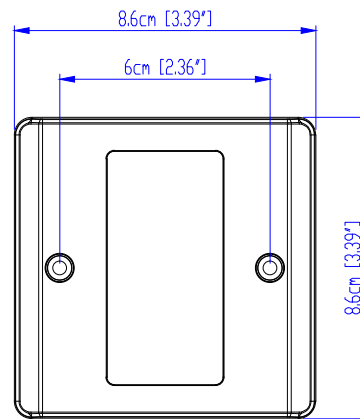

ATEN
VE157R

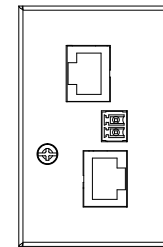
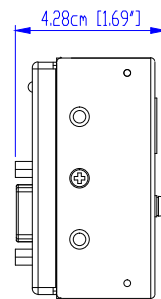
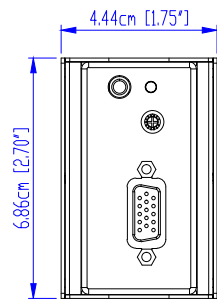
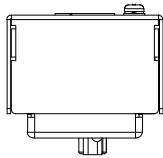
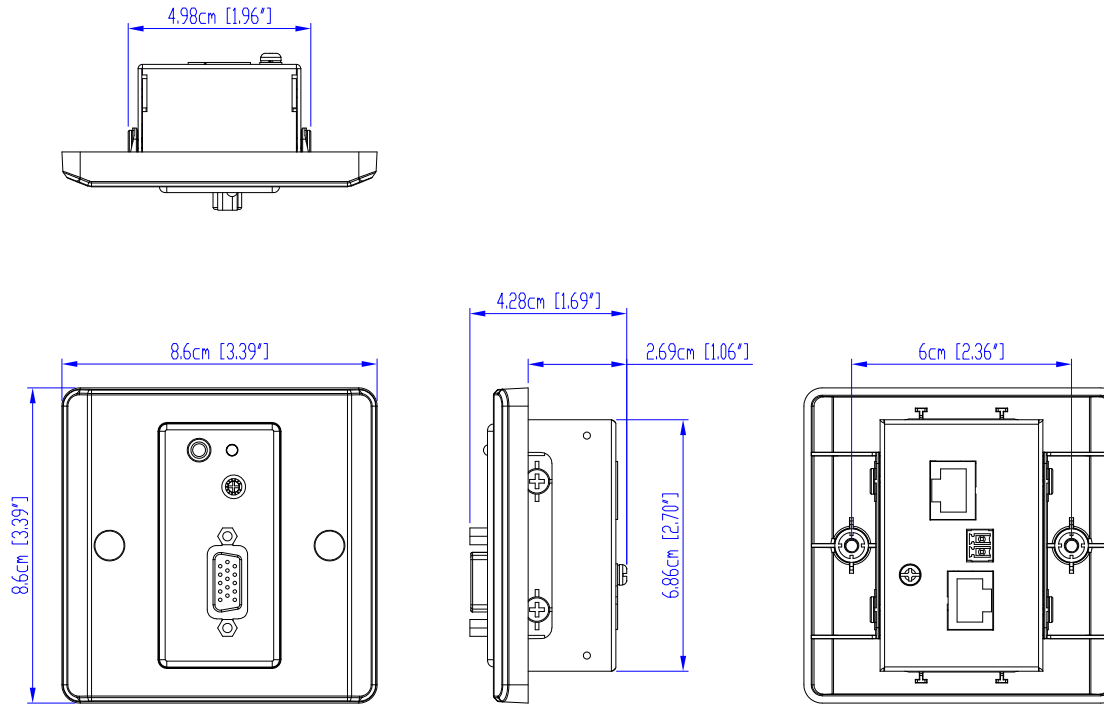

ATEN

VE157R

Panel Mount Cutout

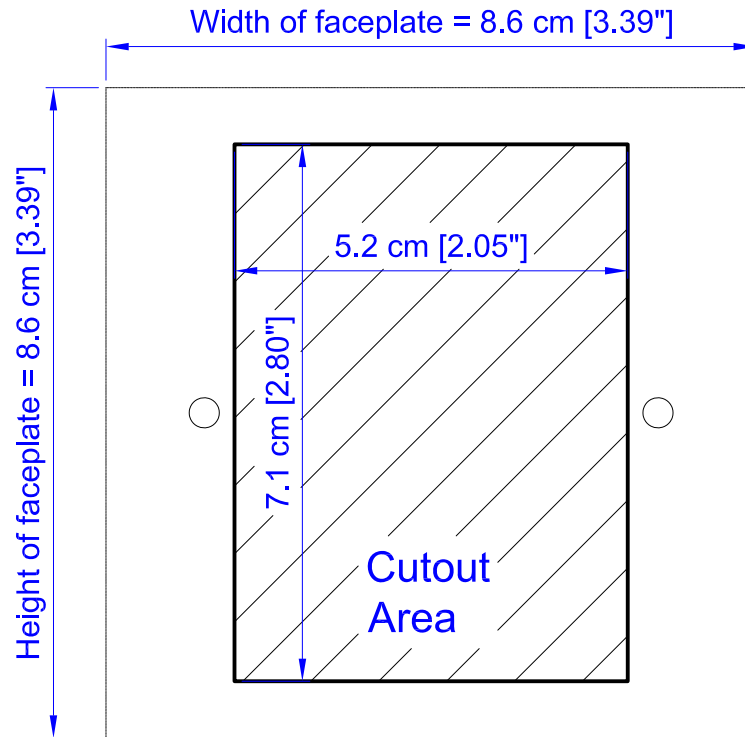

Note: ATEN recommends a 1-gang wall box with a depth of at least 4.5 cm (1.77 inches) to accommodate the connectors and cables.



VE157/607/807